

Product designation				Rotary cam switches
Product type designation				GX16
General characteristics				
Switching diagram				25 - 1-phase motor reversing switch with spring return
N° of elements				2
Mounting form				U25 - Front mounting with red/yellow handle padlockable in 0 and protection covers
Contact characteristics				
Rated insulation voltage U_i	IEC/EN	V	690	
	UL/CSA	V	600	
Rated impulse withstand voltage U_{imp}		kV	6	
Conventional free air thermal current I_{th}	IEC/EN	A	16	
	UL/CSA	A	12	
Rated operational voltage		V	440	
Rated operational impulse voltage		kV	4	
Maximum fuse size for short-circuit protection I_n (gG)	10kA	A	16	
	15kA	A	16	
	25kA	A	16	
Rated short time current I_{cw}	1s	A	250	
Conductivity				10/5 mA/V
Operational current I_e IEC/EN				
AC1/AC21A		A	16	
AC15	110V	A	10	
	220/230V	A	8	
	380/400V	A	4	
	660/690V	A	1.5	
Rated operational power in AC				
Three-phase AC-3	220/230V	kW	3.5	
	380/440V	kW	4.5	
	500/690V	kW	5.5	
Single-phase AC-3	110V	kW	0.55	
	220/230V	kW	1.5	
	380/440V	kW	2.2	
Three-phase AC23A	220/230V	kW	3.7	
	380/440V	kW	6.5	
	500/690V	kW	7.5	
Single-phase AC23A				

	110V	kW	0.75
	220/230V	kW	1.8
	380/440V	kW	3
<hr/>			
Rated operational current in DC			
DC21A			
	48V	A	16
	60V	A	16
	110V	A	4
	220V	A	0.6
	440V	A	0.25
<hr/>			
DC23A (poles in series)			
	24V	A	16 (1)
	48V	A	16 (2)
	60V	A	16 (3)
	110V	A	10 (3)
	220V	A	7 (4)
<hr/>			
DC13			
	24V	A	16
	48V	A	14
	60V	A	10
	110V	A	1
	220V	A	0.4
	440V	A	0.15
<hr/>			
Power dissipation		W	0.6
Mechanical features			
Terminals screw			3M
Tightening torque for terminals max		Nm	0.5
<hr/>			
Conductor size			
AWG - Rigid cable			
	min	AWG	20
	Max	AWG	12
<hr/>			
AWG - Flexible cable			
	min	AWG	20
	Max	AWG	12
<hr/>			
Conductor size (IEC) - Flexible cable			
	min	mm ²	0.5
	Max	mm ²	2.5
<hr/>			
Conductor size (IEC) - Rigid cable			
	min	mm ²	0.5
	Max	mm ²	2.5
<hr/>			
Mechanical life		cycles	1X10 ⁶
UL technical data			
Motor power for direct-on-line control			
for three-phase motor			
	120V	HP	1.5
	240V	HP	3
	480V	HP	5
	600V	HP	5
<hr/>			
for single-phase motor			
	120V	HP	0.75
	240V	HP	1
<hr/>			
Ambient conditions			
Temperature			
Operating temperature			

min	°C	-25
max	°C	+55

Storage temperature

min	°C	-40
max	°C	+70

Resistance & Protection

Frontal IP degree	IP65
Terminals IP degree	IP20

Dimensions

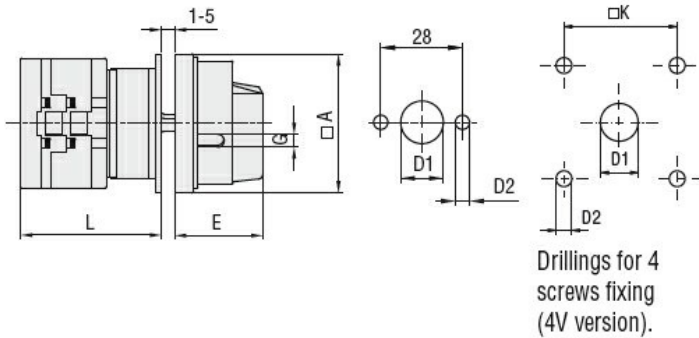

Series	Dimensions						L			
	□A	D1	D2	E	G	□K	1	2	3...12	
GX16	48	12	5	34.2	5	36	43	51.5	60	136.5
GX20	48	12	5	34.2	5	36	43	51.5	60	136.5
GX32	65	14	5	38	6	48	51	63	75	183
GX40	65	14	5	38	6	48	51	63	75	183

Wiring diagrams

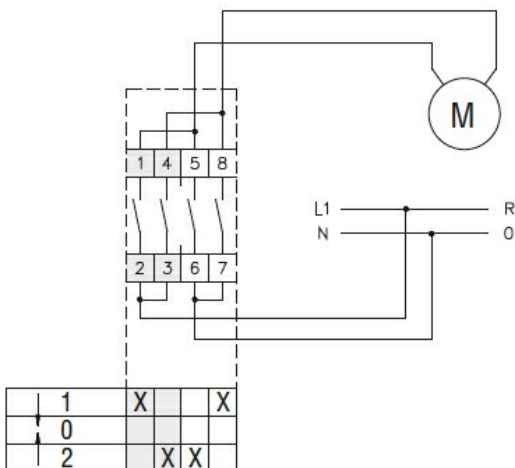

Certifications and compliance

Compliance

- CSA C22.2 n° 14
- IEC/EN/BS 60947-1
- IEC/EN/BS 60947-3
- IEC/EN/BS 60947-5-1
- IEC/EN/BS 61058-1
- UL60947-4-1

Certificates

cULus

EAC

ETIM classification

ETIM 8.0

EC001029 -
Selector switch,
complete