



Product designation				Power contactor
Product type designation				BG09
Contact characteristics				
Number of poles	Nr.			4
Rated insulation voltage U_i IEC/EN	V			690
Rated impulse withstand voltage U_{imp}	kV			6
Operational frequency	min	Hz	25	
	max	Hz	400	
IEC Conventional free air thermal current I_{th}	A			20
Operational current I_e	AC-1 ($\leq 40^\circ\text{C}$)	A	20	
	AC-1 ($\leq 55^\circ\text{C}$)	A	18	
	AC-1 ($\leq 70^\circ\text{C}$)	A	15	
	AC-3 ($\leq 440\text{V} \leq 55^\circ\text{C}$)	A	9	
	AC-4 (400V)	A	4	
Rated operational power AC-1 ($T \leq 40^\circ\text{C}$)	230V	kW	8	
	400V	kW	14	
	500V	kW	16	
	690V	kW	22	
IEC max current I_e in DC1 with $L/R \leq 1\text{ms}$ with 1 poles in series	$\leq 24\text{V}$	A	12	
	48V	A	10	
	75V	A	4	
	110V	A	3	
	220V	A	–	
IEC max current I_e in DC1 with $L/R \leq 1\text{ms}$ with 2 poles in series	$\leq 24\text{V}$	A	15	
	48V	A	14	
	75V	A	9	
	110V	A	8	
	220V	A	–	
IEC max current I_e in DC1 with $L/R \leq 1\text{ms}$ with 3 poles in series	$\leq 24\text{V}$	A	16	
	48V	A	16	
	75V	A	10	
	110V	A	10	
	220V	A	2	
IEC max current I_e in DC1 with $L/R \leq 1\text{ms}$ with 4 poles in series	$\leq 24\text{V}$	A	16	
	48V	A	16	
	75V	A	10	
	110V	A	10	
	220V	A	2	

IEC max current I_e in DC3-DC5 with $L/R \leq 15\text{ms}$ with 1 poles in series	$\leq 24\text{V}$	A	7	
	48V	A	6	
	75V	A	2	
	110V	A	1	
	220V	A	–	
	IEC max current I_e in DC3-DC5 with $L/R \leq 15\text{ms}$ with 2 poles in series	$\leq 24\text{V}$	A	8
48V		A	8	
75V		A	5	
110V		A	4	
220V		A	–	
IEC max current I_e in DC3-DC5 with $L/R \leq 15\text{ms}$ with 3 poles in series		$\leq 24\text{V}$	A	10
	48V	A	10	
	75V	A	6	
	110V	A	5	
	220V	A	0,8	
	IEC max current I_e in DC3-DC5 with $L/R \leq 15\text{ms}$ with 4 poles in series	$\leq 24\text{V}$	A	10
48V		A	10	
75V		A	6	
110V		A	5	
220V		A	0,8	
Short-time allowable current for 10s (IEC/EN60947-1)			A	96
Protection fuse	gG (IEC)	A	20	
	aM (IEC)	A	10	
Making capacity (RMS value)		A	92	
Breaking capacity at voltage	440V	A	72	
	500V	A	72	
	690V	A	72	
Resistance per pole (average value)		m Ω	10	
Power dissipation per pole (average value)	I_{th}	W	4	
	AC-3	W	0.81	
Tightening torque for terminals	min	Nm	0.8	
	max	Nm	1	
	min	Ibin	9	
	max	Ibin	9	
Tightening torque for coil terminal	min	Nm	0.8	
	max	Nm	1	
	min	Ibin	9	
	max	Ibin	9	
Max number of wires simultaneously connectable		Nr.	2	
Conductor section	AWG/Kcmil			
	max		12	
	Flexible w/o lug conductor section			
	min	mm ²	0.75	

	max	mm ²	2.5
Flexible c/w lug conductor section	min	mm ²	1.5
	max	mm ²	2.5
Flexible with insulated spade lug conductor section	min	mm ²	1.5
	max	mm ²	2.5
Power terminal protection according to IEC/EN 60529			IP20 when properly wired
Mechanical features			
Operating position	normal allowable		Vertical plan ±30°
Fixing			Screw / DIN rail 35mm
Weight		g	178
Conductor section			
AWG/kcmil conductor section	max		12
Auxiliary contact characteristics			
Thermal current I _{th}		A	10
IEC/EN 60947-5-1 designation			A600
Operations			
Mechanical life		cycles	20000000
Electrical life		cycles	500000
Safety related data			
Performance level B10d according to EN/ISO 13489-1	rated load mechanical load	cycles	500000
		cycles	20000000
Mirror contacts according to IEC/EN 60947-4-1			yes
EMC compatibility			yes
AC coil operating			
Rated AC voltage at 50/60Hz		V	24
AC operating voltage			
of 50/60Hz coil powered at 50Hz			
pick-up	min	%Us	75
	max	%Us	115
drop-out	min	%Us	20
	max	%Us	55
of 50/60Hz coil powered at 60Hz			
pick-up	min	%Us	80
	max	%Us	115
drop-out	min	%Us	20
	max	%Us	55
AC average coil consumption at 20°C			
of 50/60Hz coil powered at 50Hz			
	in-rush	VA	30
	holding	VA	4
of 50/60Hz coil powered at 60Hz			
	in-rush	VA	25

	holding	VA	3
of 60Hz coil powered at 60Hz			
	in-rush	VA	30
	holding	VA	4
Dissipation at holding ≤20°C 50Hz		W	0.95
Max cycles frequency			
Mechanical operation		cycles/h	3600
Operating times			
Average time for Us control			
in AC			
	Closing NO	min	ms 12
		max	ms 21
	Opening NO	min	ms 9
		max	ms 18
	Closing NC	min	ms 17
		max	ms 26
	Opening NC	min	ms 7
		max	ms 17
in DC			
	Closing NO	min	ms 18
		max	ms 25
	Opening NO	min	ms 2
		max	ms 3
	Closing NC	min	ms 3
		max	ms 5
	Opening NC	min	ms 11
		max	ms 17
UL technical data			
Full-load current (FLA) for three-phase AC motor			
	at 480V	A	7.6
	at 600V	A	6.1
Yielded mechanical performance			
for single-phase AC motor			
	110/120V	HP	0.5
	230V	HP	1.5
for three-phase AC motor			
	200/208V	HP	2
	220/230V	HP	3
	460/480V	HP	5
	575/600V	HP	5
General USE			
Contactor			
	AC current	A	20
Short-circuit protection fuse, 600V			
High fault			
	Short circuit current	kA	100

	Fuse rating	A	30
	Fuse class		J
Standard fault	Short circuit current	kA	5
	Fuse rating	A	30
	Fuse class		RK5

Ambient conditions

Temperature

Operating temperature

min	°C	-50
max	°C	+70

Storage temperature

min	°C	-60
max	°C	+80

Max altitude

m 3000

Resistance & Protection

Pollution degree

3

Dimensions

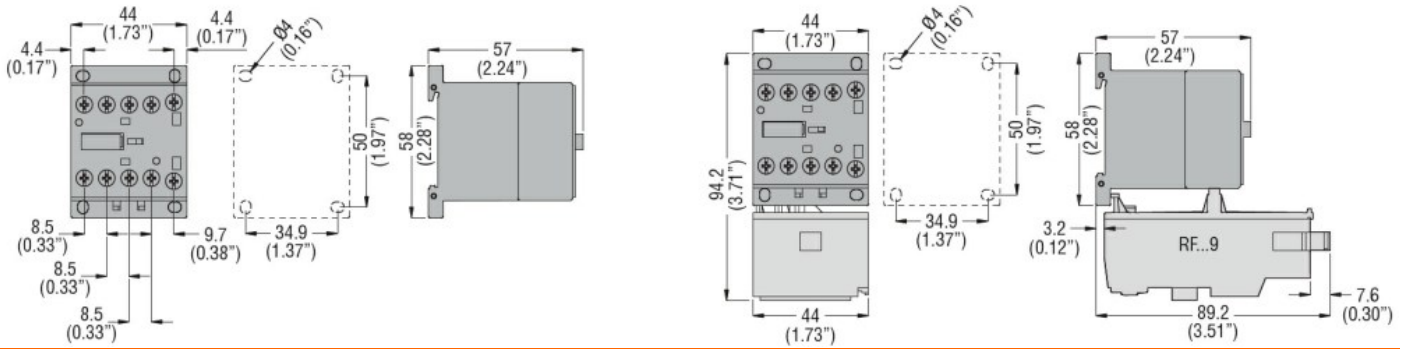

Wiring diagrams

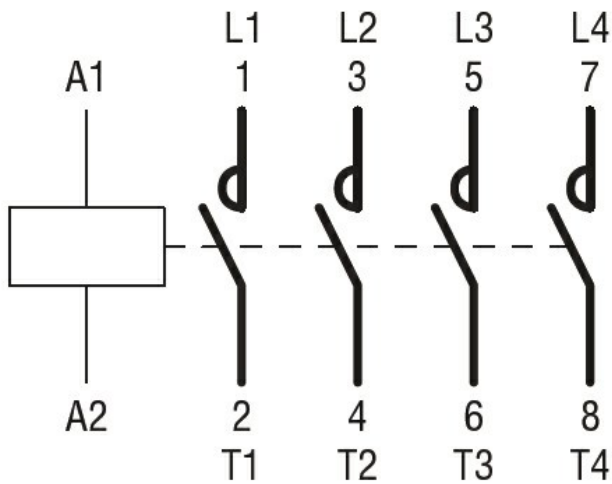

Certifications and compliance

Compliance

- CSA C22.2 n° 60947-1
- CSA C22.2 n° 60947-4-1
- IEC/EN 60947-1
- IEC/EN 60947-4-1
- UL 60947-1
- UL 60947-4-1

Certificates

CCC

cULus

EAC

ETIM classification

ETIM 8.0

EC000066 -
Power contactor,
AC switching