



Flush-mount LCD multimeters. expandable DMG611 Three-phase + neutral

Product designation

Product type designation

Type

Auxiliary supply Us

Auxiliary rated supply voltage AC	VAC	100...440
Auxiliary rated supply voltage DC	VDC	120...250
Auxiliary operating voltage range		
AC		
	min	VAC 90
	Max	VAC 484
DC		
	min	VDC 93.5
	Max	VDC 300

Operational frequency		
	min	Hz 45
	max	Hz 66

Power consumption	Max	VA 9.5
-------------------	-----	--------

Power dissipation Max	W	3.5
-----------------------	---	-----

Measuring voltage inputs

Rated voltage (Ue)		
	phase-phase	VAC 600
	phase-neutral	VAC 300

Operating voltage range		
	phase-phase	VAC 50...720
	phase-neutral	VAC 30...360

Voltage inputs operational frequency		
	min	Hz 45
	max	Hz 66

Voltage inputs measurement method	True RMS	
Connection method	Single. two. three-phase with or without neutral. balanced three-phase system	

Current inputs

Rated current (Ie)	A	1A/5A
Current reading through Rogowski coils	A	20...6300
Measurement range	0.025...6A	
Measurement method	TRMS	

Overload capacity	+20% Ie by external CT with 5A secondary	
-------------------	--	--

FLUSH-MOUNT LCD MULTIMETER, EXPANDABLE, BACKLIGHT ICON LCD DISPLAY, 72X46MM/2.8X1.8", AUXILIARY SUPPLY 100-440VAC/120-250VDC, FRONT OPTICAL PORT AND RS485 PORTS. CURRENT READING THROUGH 3 ROGOWSKI COILS INCLUDED, MAX CURRENT 100A

Overload peak	A	50A for 1s
Current		
IEC maximum (Imax)	A	100
Accuracy		
	VLN voltage	±0.5%
	VLL voltage	±0.5%
	Current	±0.5%
	Frequency	±0.05%
	Active power	±0.5%
	Active energy	Class 1 (IEC/EN 62053-21)
	Reactive energy	Class 2 (IEC/EN 62053-23)
Insulations		
Rated insulation voltage Ui IEC/EN	V	600
Rated impulse withstand voltage Uimp	kV	9.5
Operating frequency withstand voltage	kV	5.2
Functions		
Harmonic analysis		15th order
PLC logic		No
Type of communication port		RS485
Ethernet-RS485 gateway function		No
Mechanical features		
Housing type		Polyamide
Terminals type		Removable
Conductor cross section		
	min	mm ² 0.2
	Max	mm ² 2.5
	min	AWG 24
	Max	AWG 12
Tightening torque (Max)		
	Nm	0.5
	lbin	4.5
Fixing		Flush-mounting
Weight	g	350
Ambient conditions		
Temperature		
	Operating temperature	
	min	°C -20
	max	°C +60
	Storage temperature	
	min	°C -30
	max	°C +80
Relative humidity	%	<90
Maximum Pollution degree		2
Protection degree		IP54
Dimensions		

FLUSH-MOUNT LCD MULTIMETER, EXPANDABLE, BACKLIGHT ICON LCD DISPLAY, 72X46MM/2.8X1.8", AUXILIARY SUPPLY 100-440VAC/120-250VDC, FRONT OPTICAL PORT AND RS485 PORTS. CURRENT READING THROUGH 3 ROGOWSKI COILS INCLUDED, MAX CURRENT 100A

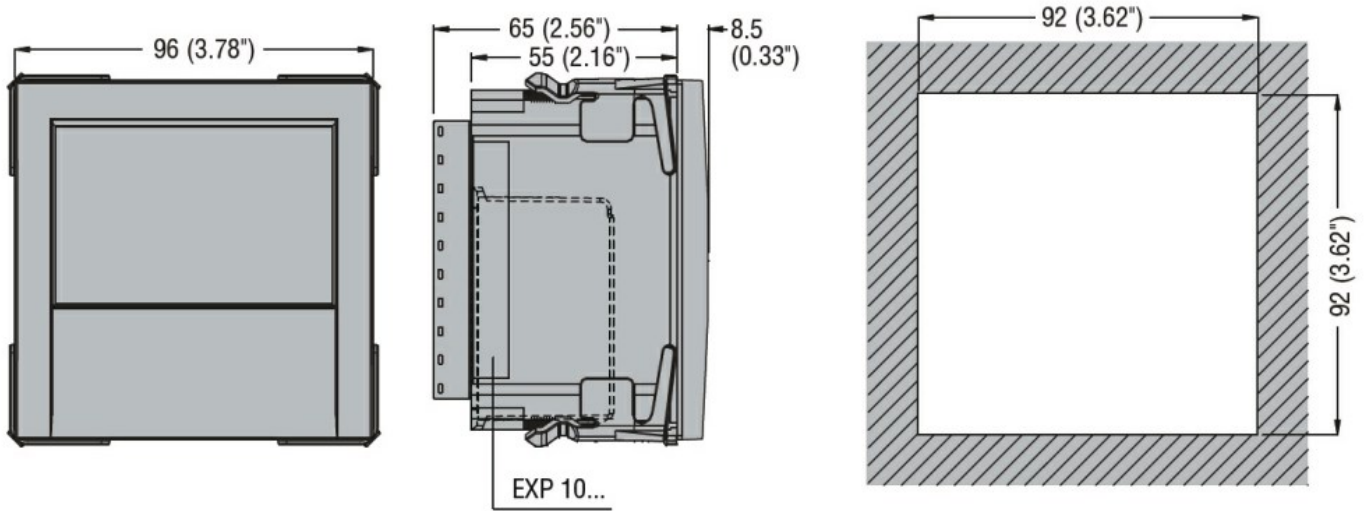

Wiring diagrams

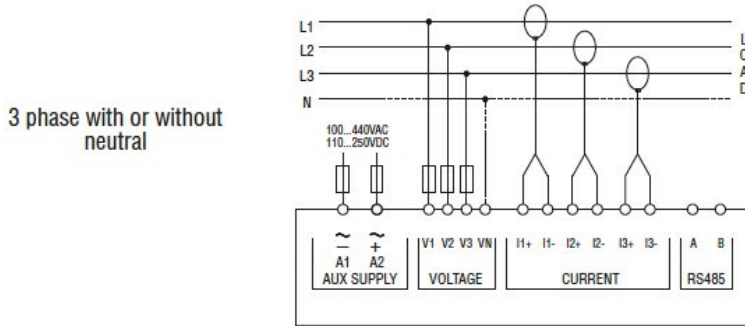

Certifications and compliance

Compliance

- IEC/EN 61000-6-2
- IEC/EN 61000-6-3
- IEC/EN 61010-1
- IEC/EN 61010-2-030

Certificates

EAC

ETIM classification

ETIM 8.0

EC002301 -
Multifunction
measuring
instrument