

EXIWAY LINE CONTROLLER

IP20  

Introduzione

Exiway Line Controller permette di controllare i dispositivi Exiway Smartled Dicube utilizzando le centraline Exiway Smart Control.

Consultare i documenti relativi per verificare le funzioni disponibili di Exiway Smart Control.

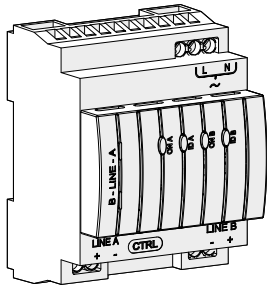

OVA53168

Schneider
Electric

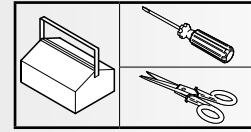
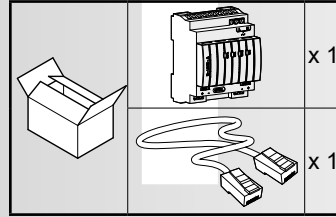

Descrizione

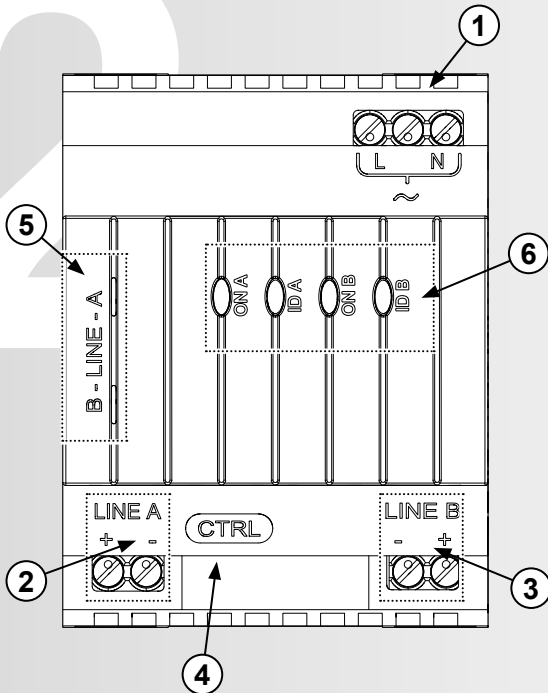

RIF.	NOME
1	Connettore alimentazione
2	Connettore linea A
3	Connettore linea B
4	Connettore RJ45 di comunicazione con Exiway Smart Control
5	LED di stato delle linee A/B (vedi sezione 6)
6	Per le funzionalità dei pulsanti e dei LED (vedi sezione 6)

Dimensioni

mm	X	Y	Z
	72	92	65

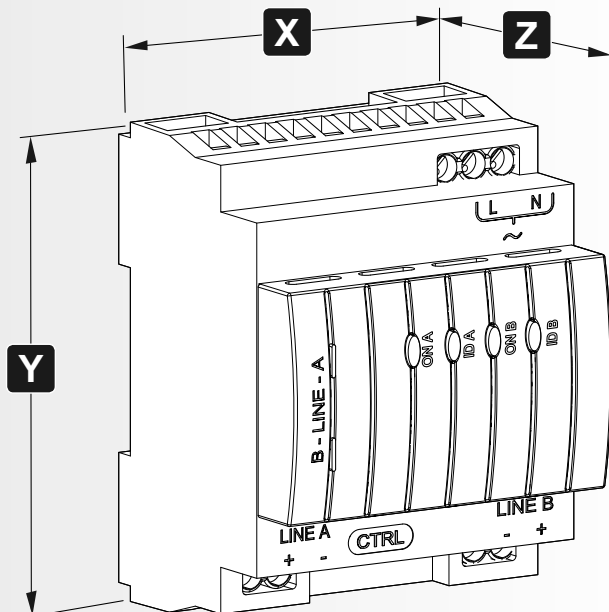

Collegamento all'alimentazione

Collegamento all'alimentazione



230VAC (220-240VAC) 50/60Hz
86 mA max
Alimentazione



AVVERTENZA: Prestare attenzione e assicurarsi che le linee A/B non siano alimentate. Se viene rilevata l'alimentazione AC su una delle linee, impedirà l'invio di qualsiasi comando.

1. I LED "ON" e "ID" dei relativi canali lampeggeranno insieme.
2. Tutti i tentativi di inviare comandi DALI andranno in errore.
3. Exiway Line Controller continuerà a rispondere ai comandi di configurazione/query.

Installazione

Vedere lo schema di collegamento al paragrafo 6:



AVVERTENZA: Prima di collegare le linee A/B, spegnere Exiway Line Controller e Exiway Smart Control.

■ Installare l'unità su una barra DIN:

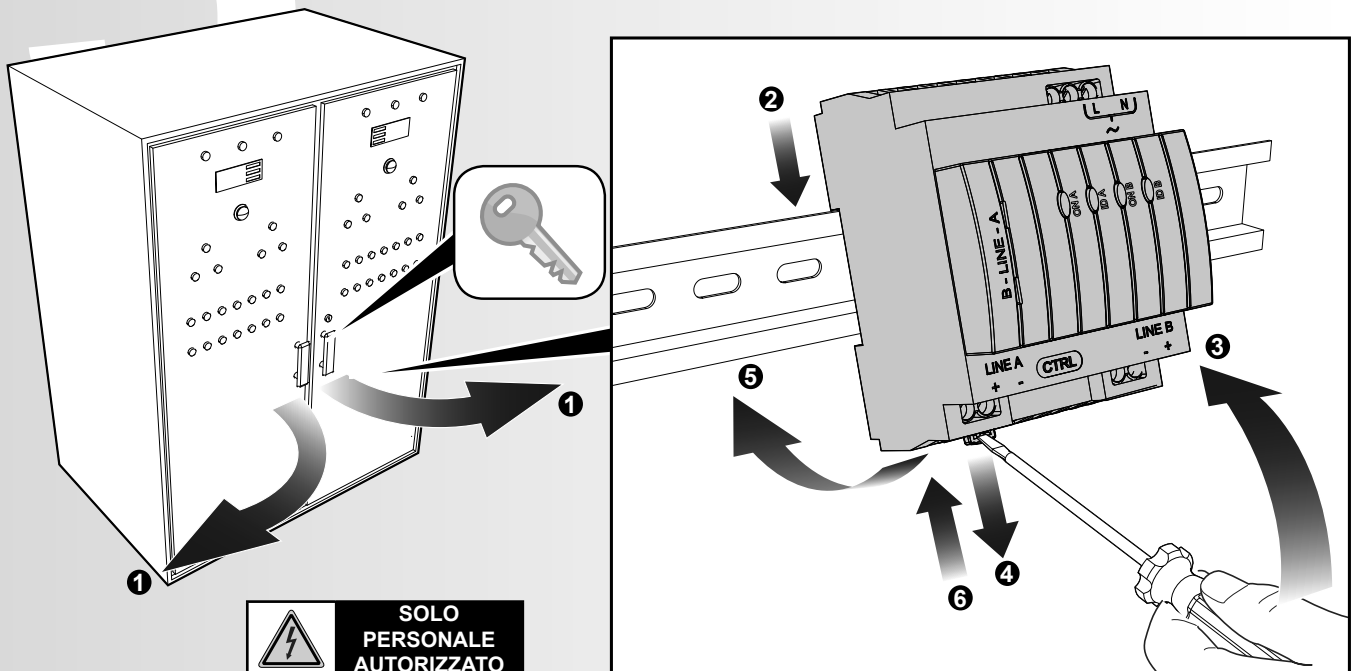

Vedere lo schema di collegamento al paragrafo 6:



AVVERTENZA: DALI non è classificabile come SELV, e il cablaggio delle linee DALI deve seguire le normative locali per il cablaggio. Assicurarsi che i cavi DALI e di alimentazione siano fissati in posizione tramite fascette. Assicurarsi che i cavi DALI e di alimentazione siano fissati in posizione tramite fascette, lontano dai cavi patch.

Durante il cablaggio delle linee DALI e dei cavi di alimentazione, assicurarsi che i filamenti di rame non entrino nelle aperture delle unità DIN.

- Collegare le linee DALI delle lampade al connettore della linea DALI A o DALI B (nel caso sia utilizzata una sola linea, deve essere utilizzata solo la linea DALI A).
- Collegare il connettore RJ45, utilizzando il cavo fornito, ad Exiway Smart Control nel connettore RS232-1 o RS232-2 (se RS232-1 è già utilizzato).
- Accendere l'alimentazione di Exiway Line Controller.
- Accendere l'alimentazione di Exiway Smart Control.
- Fare riferimento alle istruzioni di Exiway Smart Control per la messa in servizio e test del sistema.

Schema di collegamento

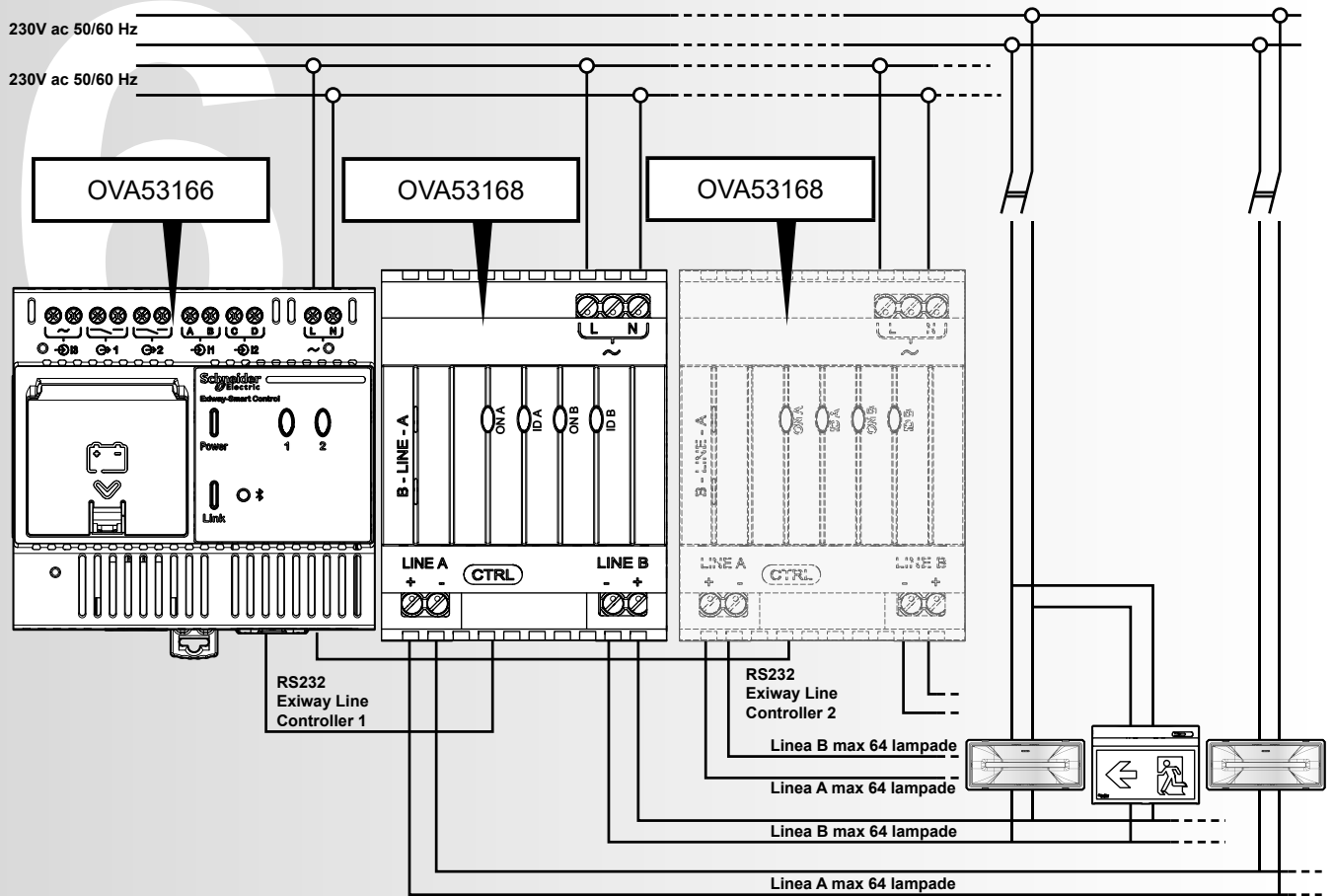

Ai morsetti di alimentazione e DALI deve essere applicata una coppia massima di 1,4Nm.

- Cavo 2 X 1,5-2,5 mm².
- Corrente: max per linea 235 mA.
- Tensione: 16 +/- 0,5 V
- Massimo 64 lampade.

Exiway Line Controller	LINEA A	1,5-2,5 mm ²	300
	LINEA B		300

Non utilizzare i pulsanti se Exiway Line Controller è collegato a Exiway Smart Control.

La tabella qui sotto contiene una lista di funzioni:

PULSANTE	AZIONE	FUNZIONE
ON A/B	Pressione breve	Attiva/disattiva la funzione permanente delle lampade linea A/B
ON A/B	Pressione lunga	Indirizza i nuovi dispositivi sulla linea A/B
ID A/B	Pressione breve	Identifica tutti i dispositivi DALI collegati alla linea A/B OPPURE interrompe la funzione in corso
ID A/B	Pressione lunga	Identifica tutti i dispositivi indirizzati sulla linea A/B

La pressione prolungata si attiva mantenendo il pulsante premuto per più di 10 secondi. Quando la funzione è attivata, il LED corrispondente lampeggia.

Le informazioni seguenti possono essere usate per comprendere la risposta visiva fornita dai LED.

LED	LINEA	STATO	CARATTERISTICA
LINEA A/B	A/B	ON	Alimentato e OK
LINEA A/B	A/B	OFF	Nessuna alimentazione, errore o cortocircuito
LINEA A/B	A/B	LAMPEGGIO VELOCE	Comunicazione DALI
ON A/B	A/B	ON	Stato default / Lampada accesa
ON A/B	A/B	OFF	Lampada spenta
ON A/B	A/B	LAMPEGGIO LENTO (5 Hz)	Indirizzamento
ID A/B	A/B	ON	Guasto
ID A/B	A/B	OFF	Nessuna esecuzione
ID A/B	A/B	LAMPEGGIO LENTO (5 Hz)	Identificazione dispositivi indirizzati
ID A/B	A/B	LAMPEGGIO VELOCE (10 Hz)	Trasmissione identificazione
ID A ON A	A	LAMPEGGIO LENTO (5 Hz)	Alimentazione AC rilevata sulla LINEA A
ID B ON B	B	LAMPEGGIO LENTO (5 Hz)	Alimentazione AC rilevata sulla LINEA B

Alimentazione	
Range di funzionamento in ingresso	220-240VAC - 86 mA max 50/60Hz
Collegamento di rete	Morsetti a vite per cavo 1,5-2,5 mm ²
Classe di isolamento	II
Linee A/B	
Corrente max (carico)	235 mA
Corrente min (carico)	5 mA
Tensione	16 +/- 0,5V
Numero di linee	2
Collegamento	Morsetti a vite per cavo 1-4 mm ²
Exiway Smart Controller	
-	Presca 2 x RJ45 (1 presa non è usata)
Ambiente	
Temperatura ambiente di funzionamento	Da 0°C a + 50°C
Caratteristiche fisiche	
Peso	171 grammi

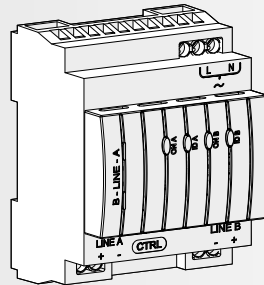

SMALTIMENTO

Il cassetto barrato riportato sull'apparecchio indica che, alla fine della propria vita utile, il prodotto deve essere consegnato ai centri di raccolta o enti autorizzati. L'adeguata raccolta differenziata e il riciclaggio dell'apparecchio dismesso durante la fase di smaltimento favoriscono la conservazione delle risorse naturali e assicurano il corretto riciclaggio, con una riduzione dei possibili effetti negativi sulla salute e sull'ambiente. Per maggiori informazioni sui centri di raccolta, modalità e termini di legge in vigore, si prega di rivolgersi all'ente locale competente.

EXIWAY LINE CONTROLLER

IP20  

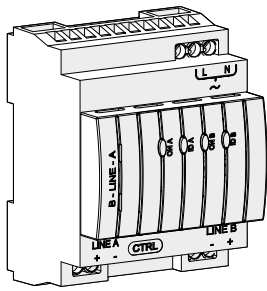

OVA53168



Introduction

Exiway Line Controller enables controlling Exiway Smartled Dicube devices via the Exiway Smart Control units.

See the dedicated documents to check the functions available on Exiway Smart Control.

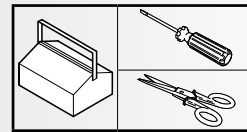
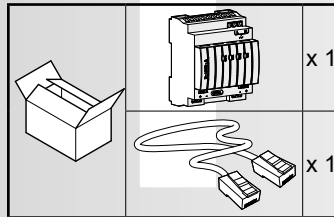

Description

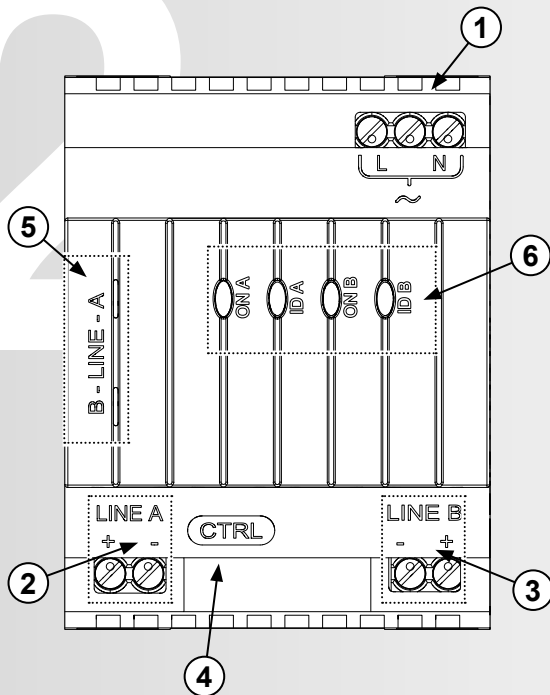

REF.	NAME
1	Power supply connector
2	Line A connector
3	Line B connector
4	RJ45 connector for the communication to Exiway Smart Control
5	Status Leds of the Lines A/B (see section 6)
6	For the function of the buttons and LEDs (see section 6)

Dimensions

mm	X	Y	Z
	72	92	65

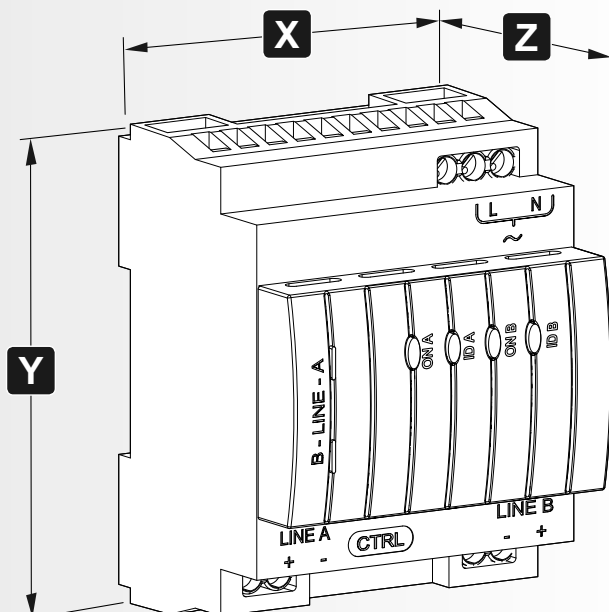

Power supply connection

Power supply connection

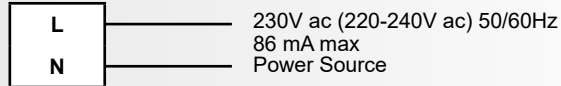

WARNING: Care should be taken to ensure that the Lines A/B are not connected to mains voltage.

If AC Mains is detected on either lines, it will prevent sending any commands.

1. ON and ID LEDs for the affected channel will flash together.
2. Any attempt to send DALI commands will result in error.
3. The Exiway Line Controller will still respond to configuration/query commands.

Installation

See the connection diagram of paragraph 6:



WARNING: Before the connection of the lines A/B, power off the Exiway Line Controller and the Exiway Smart Control.

- Mount the unit on DIN rail:

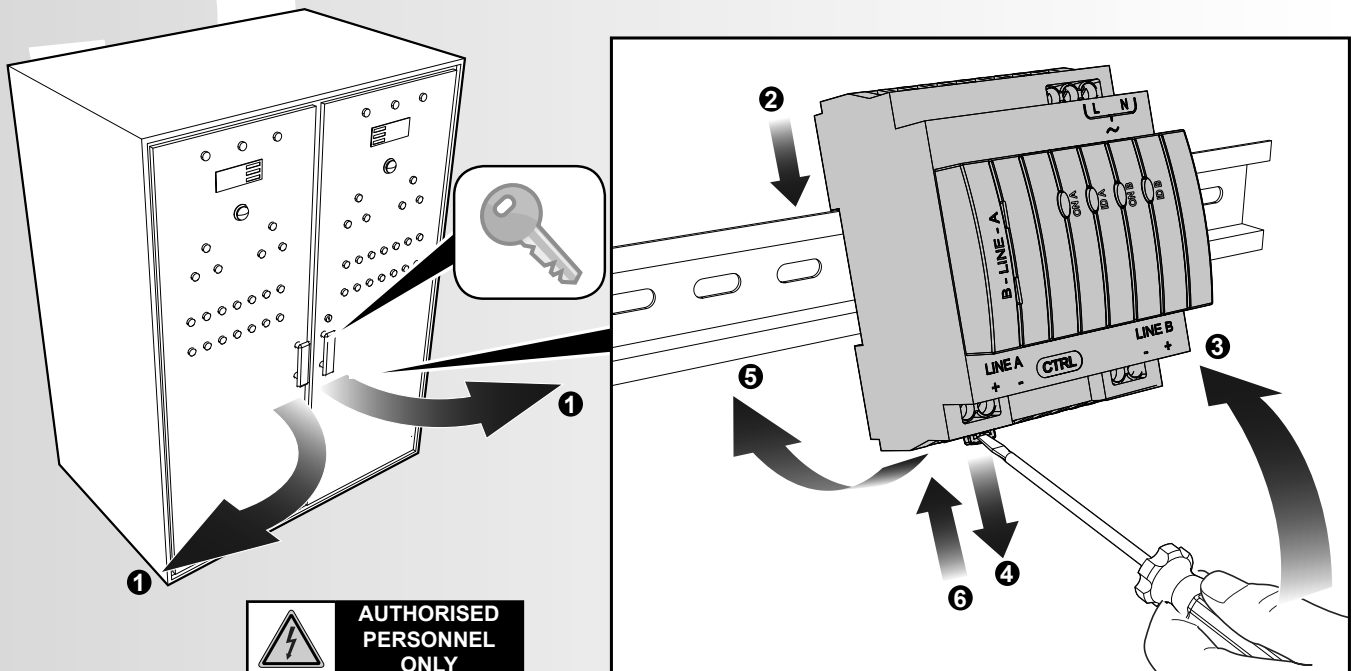

See the connection diagram of the paragraph 6:



WARNING: DALI is NOT SELV and wiring of the DALI lines needs to follow local wiring rules. Ensure that the DALI and mains wires are cable tied and secured into position. Ensure that the DALI and mains wires are cable tied and secured into position away from the patch cables.

When wiring the DALI lines and main power connection care must be taken not to allow copper strands to enter the DIN unit's apertures.

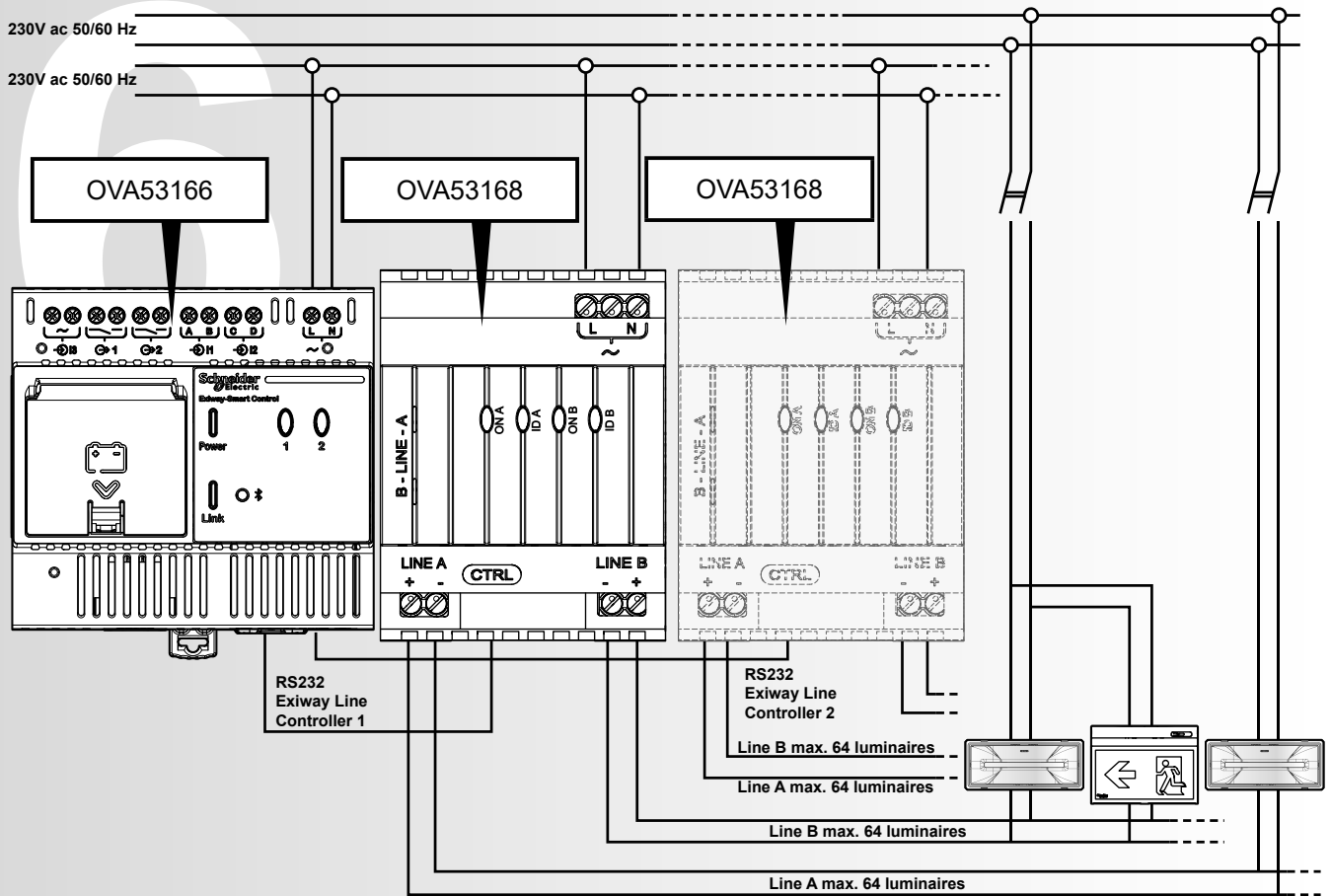

- Connect the DALI Lines of the luminaires to the DALI A or DALI B Line connector (if is used only one line must be used only the DALI Line A).
- Connect the RJ45 connector using the cable provided, to the Exiway Smart Control in the connector RS232-1 or RS232-2 (if RS232-1 is already used).
- Power supply the Exiway Line Controller.
- Power supply the Exiway Smart Control.
- See the Exiway Smart Control instruction for the commissioning and to test the system.

Wiring diagram



A maximum torque of 1.4Nm should be applied to the mains and DALI terminals.

- 2 X 1,5-2,5 mm² CABLE.
- Current: max for line 235 mA.
- Voltage: 16 +/- 0,5 V
- Maximum 64 luminaires.

			
Exiway Line Controller	LINE A	1,5-2,5 mm ²	300
	LINE B		300

Do not use the buttons if the Exiway Line Controller is connected to Exiway Smart Control.

The following table contains a list of the functions:

BUTTON	ACTION	FUNCTION
ON A/B	Short Press	Toggle line A/B lighting ON or OFF
ON A/B	Long Press	Address new devices on line A/B
ID A/B	Short Press	Identify all DALI devices connected to line A/B OR stop running function
ID A/B	Long Press	Identify all addressed devices on line A/B

A long press can be activated by holding the button down for a period exceeding 10 seconds. When the function is activated the corresponding LED will flash.

The following information can be used to understand the visual feedback provided by the LEDs.

LED	LINE	STATUS	FEATURE
LINE A/B	A/B	ON	Powered and OK
LINE A/B	A/B	OFF	No power, error or short
LINE A/B	A/B	FAST FLICKER	DALI communication
ON A/B	A/B	ON	Default state / Lighting on
ON A/B	A/B	OFF	Lighting off
ON A/B	A/B	SLOW FLASHING (5 Hz)	Addressing
ID A/B	A/B	ON	Fault
ID A/B	A/B	OFF	Nothing running
ID A/B	A/B	SLOW FLASHING (5 Hz)	Identifying addressed devices
ID A/B	A/B	FAST FLASHING (10 Hz)	Broadcasting identify
ID A ON A	A	SLOW FLASHING (5 Hz)	AC has been detected on LINE A
ID B ON B	B	SLOW FLASHING (5 Hz)	AC has been detected on LINE B

Technical features

Power Supply	
Operating Input Range	220-240V ac - 86 mA max 50/60Hz
Mains connection	Screw terminals for 1,5-2,5 mm ² cable
Insulation Class	II
Lines A/B	
Current (load) max	235 mA
Current (load) min	5 mA
Voltage	16 +/- 0.5V
Number of lines	2
Connection	Screw terminals for 1-4 mm ² cable
Exiway Smart Controller	
-	2 x RJ45 Socket (1 Socket is not used)
Environment	
Environment Operating Temperature	0°C to + 50°C
Physical features	
Weight	171 grams

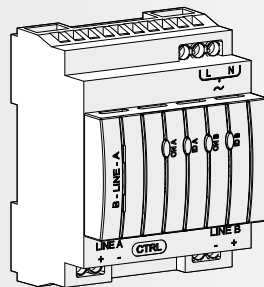

DISPOSAL

The crossed out wheeled bin symbol on the product indicates that at the end of its life the product shall be returned to authorized waste collection centers or to whom has the right to manage it. The proper separate collection and recycling of waste equipment at the time of disposal will help to protect natural resources and ensure that it is recycled in a manner that reduces possible negative effects on human health and the environment. For more information regarding waste collection centers, modalities and terms of law in force, please contact your local waste disposal authority.

EXIWAY LINE CONTROLLER

IP20  

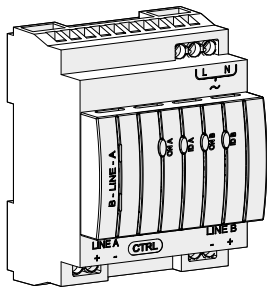

OVA53168

Schneider
Electric

Introduction

Exiway Line Controller permet de contrôler les dispositifs Exiway Smartled Dicube à l'aide des centrales Exiway Smart Control.

Consulter les documents relatifs pour vérifier les fonctions disponibles d'Exiway Smart Control.

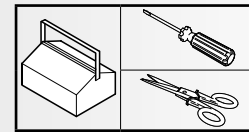
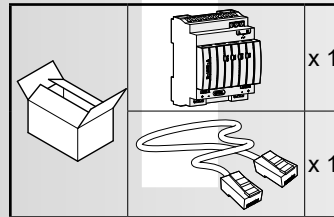

Description

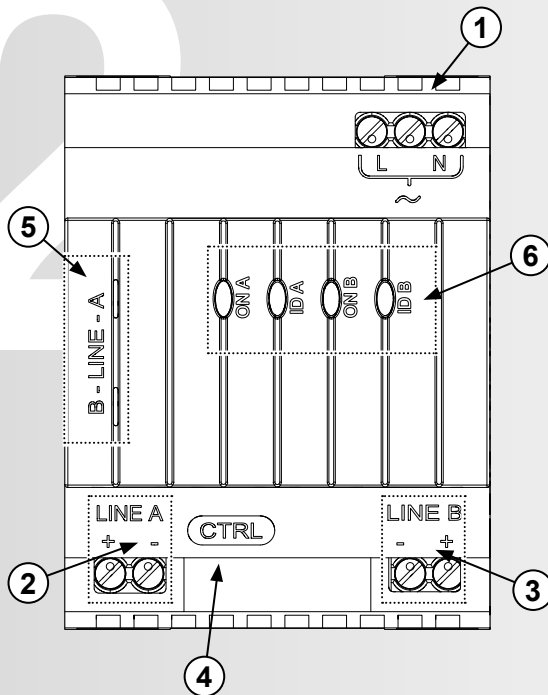

RÉF.	NOM
1	Connecteur d'alimentation
2	Connecteur de ligne A
3	Connecteur de ligne B
4	Connecteur RJ45 de communication avec Exiway Smart Control
5	LED d'état des lignes A/B (voir section 6)
6	Pour les fonctionnalités des boutons et des LED (voir section 6)

Dimensions

mm	X	Y	Z
	72	92	65

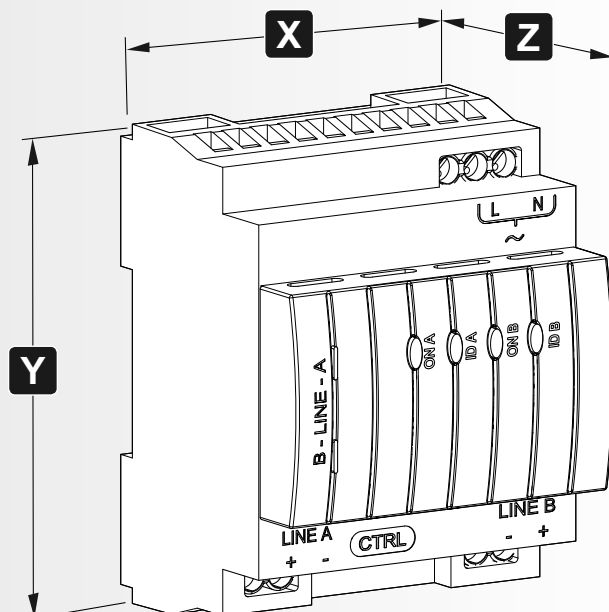

Branchement sur l'alimentation

Branchement sur l'alimentation

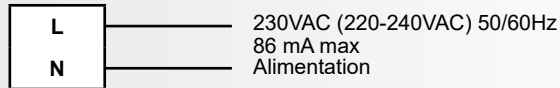

AVERTISSEMENT : Faire attention et s'assurer que les lignes A/B ne sont pas alimentées.
Si l'alimentation AC est détectée sur l'une des lignes, elle empêchera l'envoi de toute commande.

1. Les LED « ON » et « ID » des canaux relatifs clignoteront en même temps.
2. Toutes les tentatives d'envoi des commandes DALI se solderont par une erreur.
3. Exiway Line Controller continuera de répondre aux commandes de configuration/query.

Installation

Voir le schéma de connexion au paragraphe 6 :



AVERTISSEMENT : Avant de connecter les lignes A/B, éteindre Exiway Line Controller et Exiway Smart Control.

- Installer l'unité sur une barre DIN :

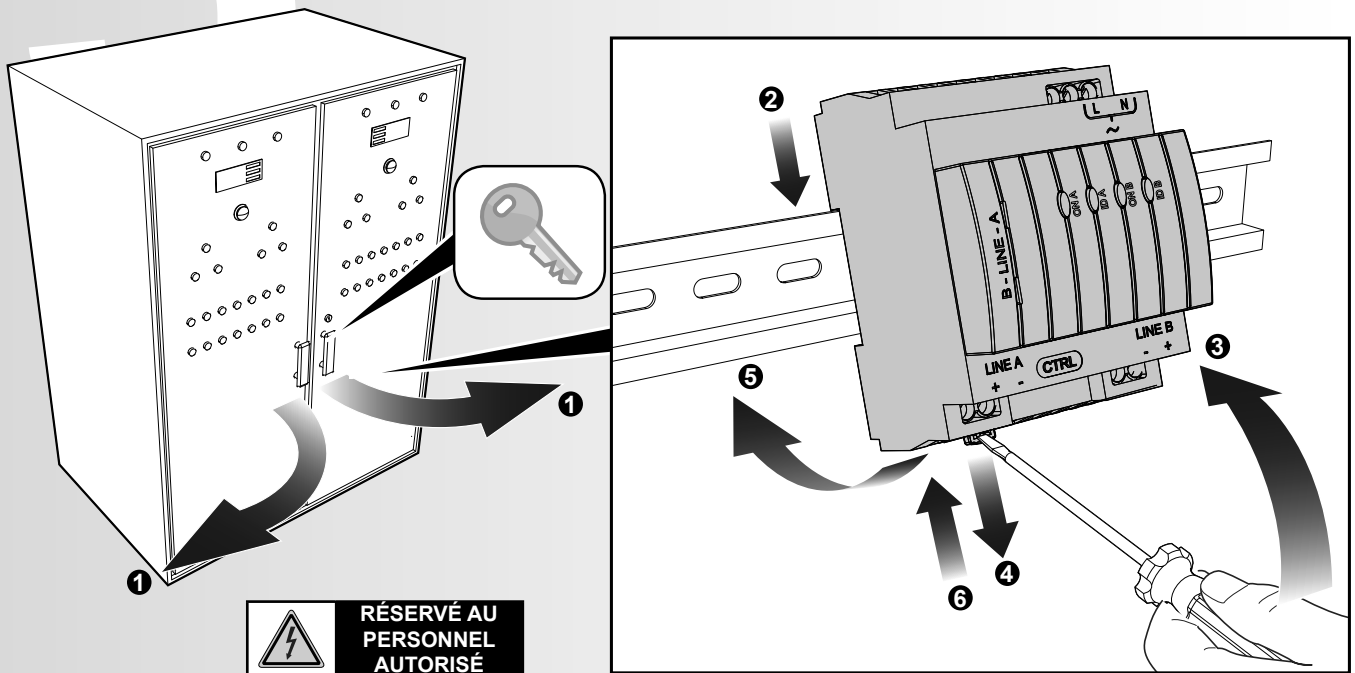

Voir le schéma de connexion au paragraphe 6 :



AVERTISSEMENT : DALI ne peut pas être classé comme SELV, et le câblage des lignes DALI doit respecter les normes locales de câblage. S'assurer que les câbles DALI et d'alimentation sont fixés en position par des serre-câbles. S'assurer que les câbles DALI et d'alimentation sont fixés en position par des serre-câbles, à l'écart des câbles patch.

Pendant le câblage des lignes DALI et des câbles d'alimentation, s'assurer que les filaments de cuivre n'entrent pas dans les ouvertures des unités DIN.

- Connecter les lignes DALI des blocs au connecteur de la ligne DALI A ou DALI B (si une seule ligne est utilisée, seule la ligne DALI A doit être utilisée).
- Connecter le connecteur RJ45, à l'aide du câble fourni, à Exiway Smart Control dans le connecteur RS232-1 ou RS232-2 (si RS232-1 est déjà utilisé).
- Allumer l'alimentation d'Exiway Line Controller.
- Allumer l'alimentation d'Exiway Smart Control.
- Faire référence aux instructions d'Exiway Smart Control pour la mise en service et le test du système.

Schéma de connexion

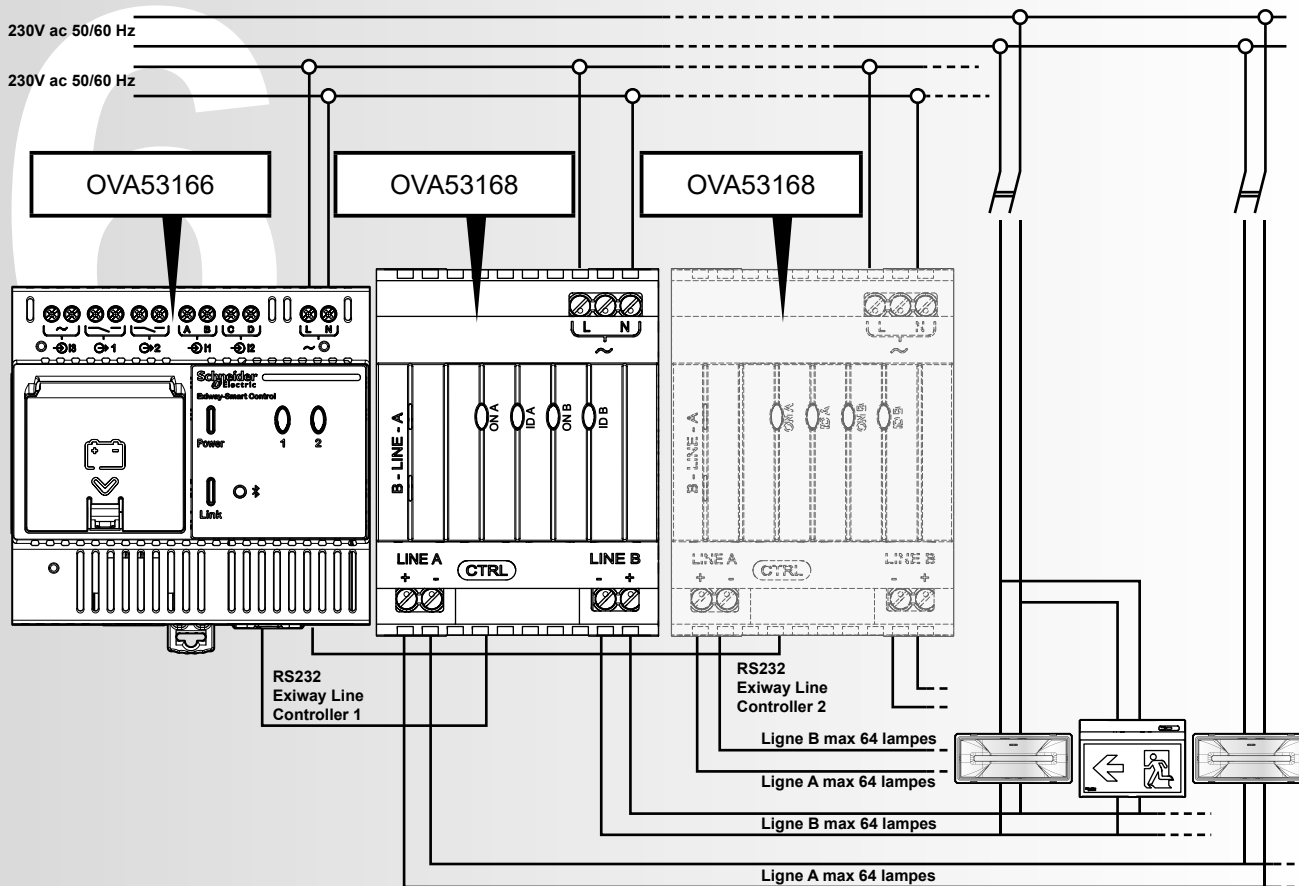

Un couple maximum de 1,4 Nm doit être appliqué sur les bornes d'alimentation et DALI.

- Câble 2 X 1,5-2,5 mm².
- Courant : max pour ligne 235 mA.
- Tension : 16 +/- 0,5 V
- Maximum de 64 blocs.

Exiway Line Controller	LIGNE		D m
	A	B	
	1,5-2,5 mm ²	1,5-2,5 mm ²	300
			300

Ne pas utiliser les boutons si Exiway Line Controller est connecté à Exiway Smart Control.

Le tableau ci-dessous comporte une liste de fonctions :

BOUON	ACTION	FONCTION
ON A/B	Pression brève	(Fonctions disponible avec Exiway Smart Control OVA53166) Active/désactive la fonction permanente des blocs ligne A/B
ON A/B	Pression longue	Adresse les nouveaux dispositifs sur la ligne A/B
ID A/B	Pression brève	Identifie tous les dispositifs DALI connectés à la ligne A/B ou interrompt la fonction en cours
ID A/B	Pression longue	Identifie tous les dispositifs adressés sur la ligne A/B

La pression prolongée s'active en maintenant le bouton enfoncé pendant plus de 10 secondes. Une fois la fonction activée, la LED correspondante clignote.

Les informations suivantes peuvent servir à comprendre la réponse visuelle fournie par les LED.

LED	LIGNE	ÉTAT	CARACTÉRISTIQUE
LIGNE A/B	A/B	ON	Alimenté et OK
LIGNE A/B	A/B	OFF	Pas d'alimentation, d'erreur ou de court-circuit
LIGNE A/B	A/B	CLIGNOTEMENT RAPIDE	Communication DALI
ON A/B	A/B	ON	État par défaut / Bloc allumé
ON A/B	A/B	OFF	Bloc éteint
ON A/B	A/B	CLIGNOTEMENT LENT (5 Hz)	Adressage
ID A/B	A/B	ON	Défaillance
ID A/B	A/B	OFF	Pas d'exécution
ID A/B	A/B	CLIGNOTEMENT LENT (5 Hz)	Identification des dispositifs adressés
ID A/B	A/B	CLIGNOTEMENT RAPIDE (10 Hz)	Transmission identification
ID A ON A	A	CLIGNOTEMENT LENT (5 Hz)	Alimentation AC détectée sur la LIGNE A
ID B ON B	B	CLIGNOTEMENT LENT (5 Hz)	Alimentation AC détectée sur la LIGNE B

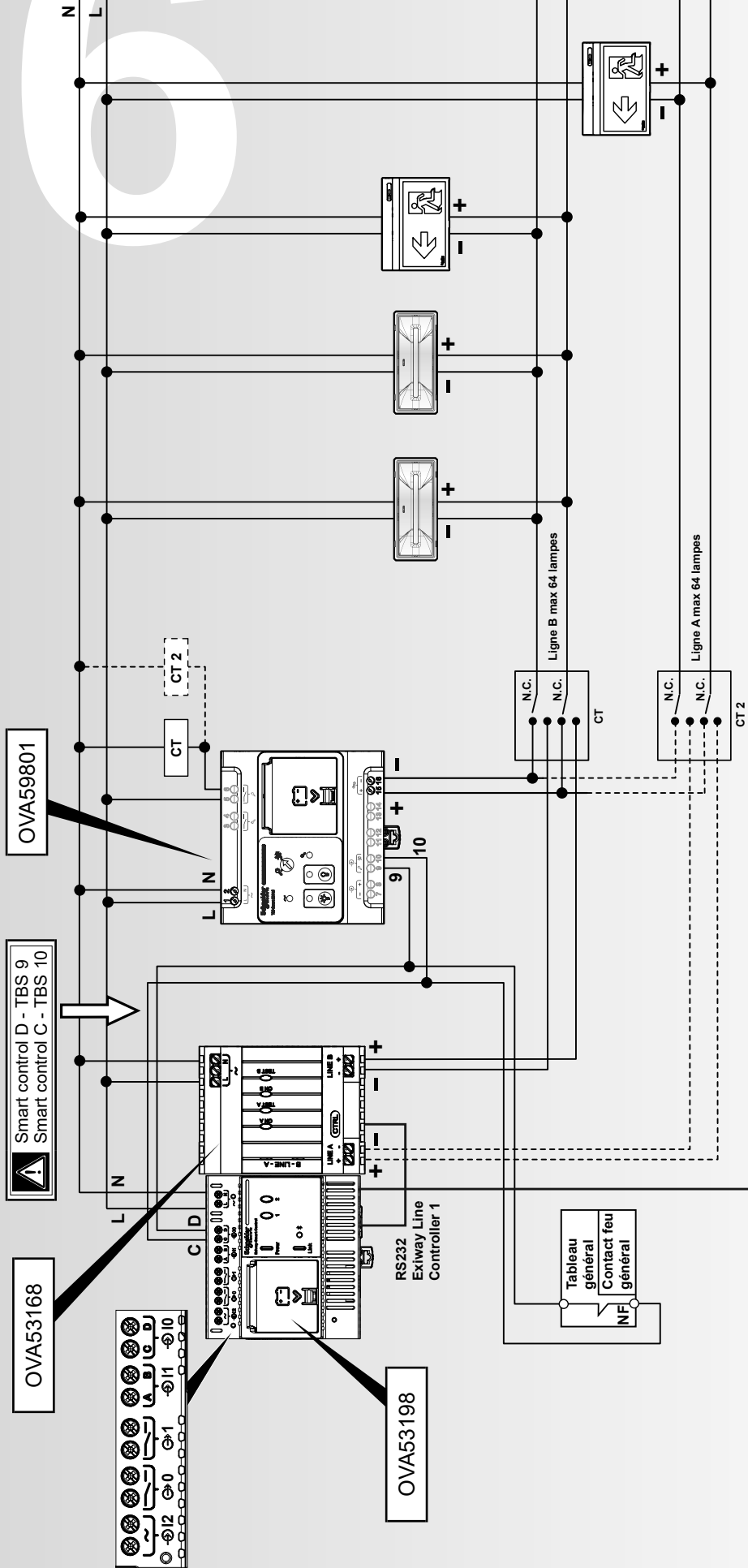

10		100
11		100
0	1-2,5 mm ²	-
1		-
12		-
L-N		-
LINE A	1,5-2,5 mm ²	300
LINE B		300

Les lignes connectées aux entrées I1 et I0 doivent être considérées comme des lignes de sécurité.

OVA59801

Smart control D - TBS 9
Smart control C - TBS 10

OVA53168

OVA53198

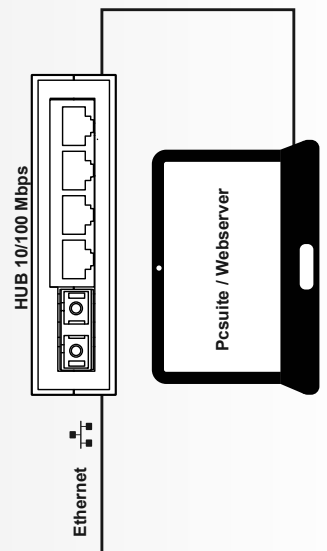

Exiway Smart Control fonctionne seulement en présence d'alimentation de secteur. Il est conseillé d'utiliser une ligne d'alimentation dédiée et séparée de la ligne des blocs Exiway Smartled Dcube.

Caractéristiques techniques

Alimentation	
Plage de fonctionnement en entrée	220-240 VAC - 86 mA max 50/60 Hz
Connexion au réseau	Bornes à vis pour câble 1,5-2,5 mm ²
Classe d'isolement	II
Lignes A/B	
Courant max (charge)	235 mA
Courant min (charge)	5 mA
Tension	16 +/- 0,5V
Nombre de lignes	2
Branchement	Bornes à vis pour câble 1-4 mm ²
Exiway Smart Controller	
-	Prise 2 x RJ45 (1 prise n'est pas utilisée)
Environnement	
Température de service ambiante	De 0°C à + 50°C
Caractéristiques physiques	
Poids	171 grammes

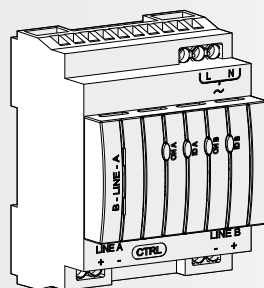

ÉLIMINATION

La poubelle barrée représentée sur le produit indique que le produit en fin de vie utile doit être remis aux centres de collecte ou organismes agréés. Le bon tri sélectif et le recyclage de l'appareil mis hors service lors de la phase d'élimination favorisent la conservation des ressources naturelles et garantissent qu'il sera recyclé de manière à réduire les éventuelles répercussions négatives sur la santé et l'environnement. Pour de plus amples détails sur les centres de collecte, les modalités et conditions de la Loi en vigueur, prendre contact avec le bureau compétent du propre organisme local.

