



# DBS60E-THEQ01024

DBS60

INCREMENTAL ENCODERS

**SICK**  
Sensor Intelligence.



Illustration may differ



### Ordering information

Type	Part no.
DBS60E-THEQ01024	1104306

Other models and accessories → [www.sick.com/DBS60](http://www.sick.com/DBS60)

### Detailed technical data

#### Performance

<b>Pulses per revolution</b>	1,024
<b>Measuring step</b>	≤ 90°, electric/pulses per revolution
<b>Measuring step deviation</b>	± 18° / pulses per revolution
<b>Error limits</b>	Measuring step deviation x 3
<b>Duty cycle</b>	≤ 0.5 ± 5 %

#### Interfaces

<b>Communication interface</b>	Incremental
<b>Communication Interface detail</b>	HTL / Push pull
<b>Number of signal channels</b>	6-channel
<b>Initialization time</b>	< 5 ms <sup>1)</sup>
<b>Output frequency</b>	+ 300 kHz <sup>2)</sup>
<b>Load current</b>	≤ 30 mA, per channel
<b>Power consumption</b>	≤ 1 W (without load)

<sup>1)</sup> Valid signals can be read once this time has elapsed.

<sup>2)</sup> Up to 450 kHz on request.

#### Electrical data

<b>Connection type</b>	Cable, 8-wire, with male connector, M23, 12-pin, universal, 0.5 m <sup>1) 2)</sup>
<b>Supply voltage</b>	10 ... 27 V
<b>Reference signal, number</b>	1
<b>Reference signal, position</b>	90°, electric, logically gated with A and B
<b>Reverse polarity protection</b>	✓
<b>Short-circuit protection of the outputs</b>	✓ <sup>3)</sup>
<b>MTTFd: mean time to dangerous failure</b>	500 years (EN ISO 13849-1) <sup>4)</sup>

<sup>1)</sup> The universal cable connection is positioned so that it is possible to lay it without bends in a radial or axial direction.

<sup>2)</sup> M23 male connector for central mounting.

<sup>3)</sup> Short-circuit opposite to another channel, US or GND permissible for maximum 30 s.

<sup>4)</sup> This product is a standard product and does not constitute a safety component as defined in the Machinery Directive. Calculation based on nominal load of components, average ambient temperature 40°C, frequency of use 8760 h/a. All electronic failures are considered hazardous. For more information, see document no. 8015532.

## Mechanical data

<b>Mechanical design</b>	Through hollow shaft, Front clamp
<b>Shaft diameter</b>	15 mm
<b>Flange type / stator coupling</b>	2-sided stator coupling, slot, screw hole circle 63–83 mm
<b>Weight</b>	+ 0.25 kg <sup>1)</sup>
<b>Shaft material</b>	Stainless steel
<b>Flange material</b>	Aluminum
<b>Housing material</b>	Aluminum
<b>Material, cable</b>	PVC
<b>Start up torque</b>	+ 0.5 Ncm (+20 °C)
<b>Operating torque</b>	0.4 Ncm (+20 °C)
<b>Permissible movement static</b>	± 0.3 mm (radial) ± 0.5 mm (axial) <sup>2)</sup>
<b>Permissible movement dynamic</b>	± 0.1 mm (radial) ± 0.2 mm (axial) <sup>2)</sup>
<b>Operating speed</b>	6,000 min <sup>-1</sup> <sup>3)</sup>
<b>Maximum operating speed</b>	9,000 min <sup>-1</sup> <sup>4)</sup>
<b>Moment of inertia of the rotor</b>	50 gcm <sup>2</sup>
<b>Bearing lifetime</b>	3.6 x 10 <sup>9</sup> revolutions
<b>Angular acceleration</b>	≤ 500,000 rad/s <sup>2</sup>

<sup>1)</sup> Based on encoder with male connector or cable with male connector.

<sup>2)</sup> Not applicable for stator coupling type C and K.

<sup>3)</sup> Allow for self-heating of 2.6 K per 1,000 rpm when designing the operating temperature range.

<sup>4)</sup> Maximum speed which does not cause mechanical damage to the encoder. Impact on the service life and signal quality is possible. Please note the maximum output frequency.

## Ambient data

<b>EMC</b>	According to EN 61000-6-2 and EN 61000-6-3
<b>Enclosure rating</b>	IP65, housing side (IEC 60529) <sup>1)</sup> IP65, shaft side (IEC 60529)
<b>Permissible relative humidity</b>	90 % (Condensation not permitted)
<b>Operating temperature range</b>	-20 °C ... +85 °C <sup>2)</sup>
<b>Storage temperature range</b>	-40 °C ... +100 °C, without package
<b>Resistance to shocks</b>	250 g, 3 ms (EN 60068-2-27)
<b>Resistance to vibration</b>	30 g, 10 Hz ... 2,000 Hz (EN 60068-2-6)

<sup>1)</sup> With mating connector fitted.

<sup>2)</sup> These values relate to all mechanical versions including recommended accessories unless otherwise noted.

## Classifications

<b>eCl@ss 5.0</b>	27270501
<b>eCl@ss 5.1.4</b>	27270501
<b>eCl@ss 6.0</b>	27270590
<b>eCl@ss 6.2</b>	27270590
<b>eCl@ss 7.0</b>	27270501

<b>eCl@ss 8.0</b>	27270501
<b>eCl@ss 8.1</b>	27270501
<b>eCl@ss 9.0</b>	27270501
<b>eCl@ss 10.0</b>	27270501
<b>eCl@ss 11.0</b>	27270501
<b>eCl@ss 12.0</b>	27270501
<b>ETIM 5.0</b>	EC001486
<b>ETIM 6.0</b>	EC001486
<b>ETIM 7.0</b>	EC001486
<b>ETIM 8.0</b>	EC001486
<b>UNSPSC 16.0901</b>	41112113

### Dimensional drawing (Dimensions in mm (inch))

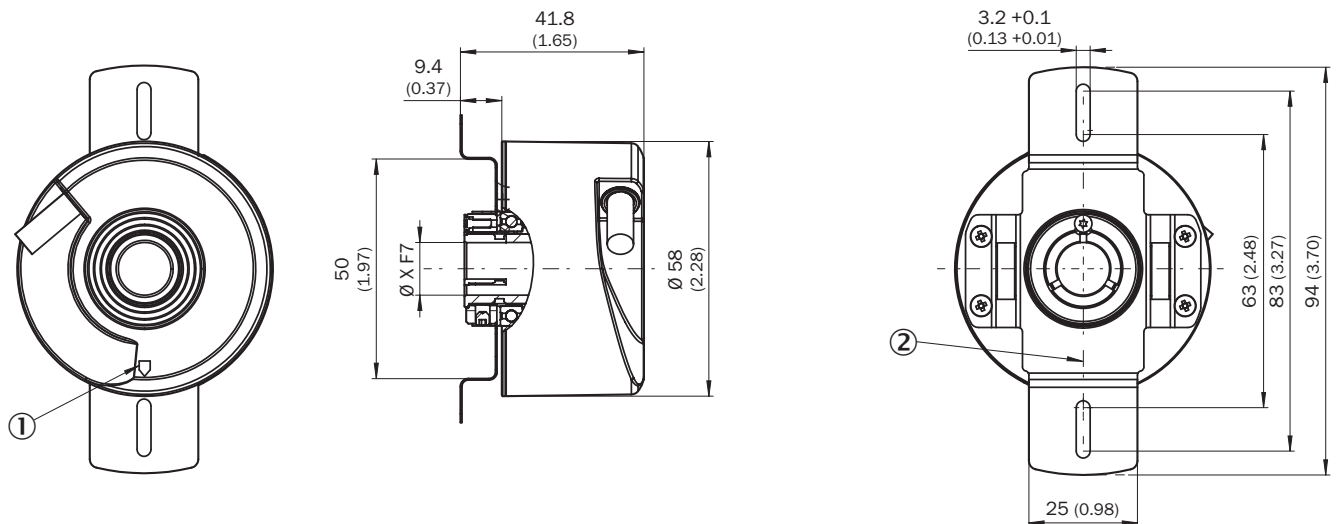

XF7 values see shaft diameter table for through hollow shaft, clamping at the front

- ① Zero pulse mark on housing
- ② Zero pulse mark on flange under stator coupling

Type Through hollow shaft with front clamping	Shaft diameter XF7
DBS60x-TAxxxxxxx DBS60x-T1xxxxxxx	6 mm
DBS60x-TBxxxxxxx DBS60x-T2xxxxxxx	8 mm
DBS60x-TCxxxxxxx DBS60x-T3xxxxxxx	3/8"
DBS60x-TDxxxxxxx DBS60x-T4xxxxxxx	10 mm
DBS60x-TExxxxxxx DBS60x-T5xxxxxxx	12 mm
DBS60x-TFxxxxxxx DBS60x-T6xxxxxxx	1/2"
DBS60x-TGxxxxxxx	14 mm

Type Through hollow shaft with front clamping	Shaft diameter XF7
DBS60x-T7xxxxxxx	
DBS60x-THxxxxxxx DBS60x-T8xxxxxxx	15 mm
DBS60x-TJxxxxxxx	5/8"

### Attachment specifications

Through hollow shaft with front clamping

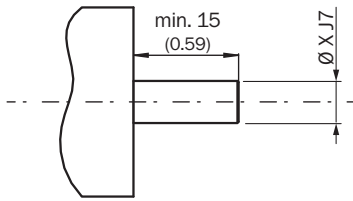

Customer side

Type Through hollow shaft with front clamping	Shaft diameter xj7
DBS60x-TAxxxxxxx DBS60x-T1xxxxxxx	6 mm
DBS60x-TBxxxxxxx DBS60x-T2xxxxxxx	8 mm
DBS60x-TCxxxxxxx DBS60x-T3xxxxxxx	3/8"
DBS60x-TDxxxxxxx DBS60x-T4xxxxxxx	10 mm
DBS60x-TExxxxxxx DBS60x-T5xxxxxxx	12 mm
DBS60x-TFxxxxxxx DBS60x-T6xxxxxxx	1/2"
DBS60x-TGxxxxxxx DBS60x-T7xxxxxxx	14 mm
DBS60x-THxxxxxxx DBS60x-T8xxxxxxx	15 mm
DBS60x-TJxxxxxxx	5/8"

### PIN assignment

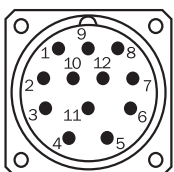

View of M23 male device connector on cable / housing

Wire colors (cable connection)	Male connector M12, 8-pin	Male connector M23, 12-pin	TTL/HTL 6-channel signal	Explanation
Brown	1	6	A-	Signal wire
White	2	5	A	Signal wire
Black	3	1	B-	Signal wire
Pink	4	8	B	Signal wire
Yellow	5	4	Z-	Signal wire
Purple	6	3	Z	Signal wire
Blue	7	10	GND	Ground connection
Red	8	12	+U <sub>s</sub>	Supply voltage
-	-	9	Not assigned	Not assigned
-	-	2	Not assigned	Not assigned
-	-	11	Not assigned	Not assigned
-	-	7	Not assigned	Not assigned
Screen	Screen	Screen	Screen	Screen connected to encoder housing

### Diagrams

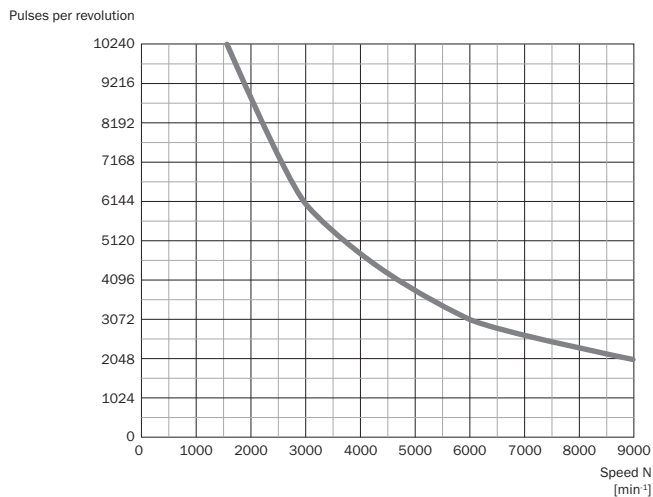

Signal outputs for electrical interfaces TTL and HTL



Cw with view on the encoder shaft in direction "A", compare dimensional drawing.

Supply voltage	Output
4,5 V ... 5,5 V	TTL
10 V ... 30 V	TTL
10 V ... 27 V	HTL
4,5 V ... 30 V	TTL/HTL universal
4,5 V ... 30 V	TTL

## Operation note

Hollow shaft









Attention! If stator coupling is mounted, the zero pulse mark can be hidden by the stator coupling

- ① Zero pulse mark on flange
- ② Zero pulse is active when screw of clamping is inline with zero pulse mark on flange or housing mark

### Recommended accessories

Other models and accessories → [www.sick.com/DBS60](http://www.sick.com/DBS60)

	Brief description	Type	Part no.
<b>Plug connectors and cables</b>			
	Head A: cable Head B: Flying leads Cable: SSI, Incremental, HIPERFACE®, PUR, halogen-free, shielded	LTG-2308-MWENC	6027529
	Head A: cable Head B: Flying leads Cable: SSI, Incremental, PUR, shielded	LTG-2411-MW	6027530
	Head A: cable Head B: Flying leads Cable: SSI, Incremental, PUR, halogen-free, shielded	LTG-2512-MW	6027531
	Head A: cable Head B: Flying leads Cable: SSI, TTL, HTL, Incremental, PUR, halogen-free, shielded	LTG-2612-MW	6028516
	Head A: female connector, M23, 12-pin, straight Head B: Flying leads Cable: Incremental, PUR, shielded, 2 m	DOL-2312-G02MLA3	2030682
	Head A: female connector, M23, 12-pin, straight Head B: Flying leads Cable: Incremental, PUR, shielded, 7 m	DOL-2312-G07MLA3	2030685
	Head A: female connector, M23, 12-pin, straight Head B: Flying leads Cable: Incremental, PUR, shielded, 10 m	DOL-2312-G10MLA3	2030688
	Head A: female connector, M23, 12-pin, straight Head B: Flying leads Cable: Incremental, PUR, shielded, 15 m	DOL-2312-G15MLA3	2030692
	Head A: female connector, M23, 12-pin, straight Head B: Flying leads Cable: Incremental, PUR, shielded, 20 m	DOL-2312-G20MLA3	2030695
	Head A: female connector, M23, 12-pin, straight Head B: Flying leads Cable: Incremental, PUR, shielded, 25 m	DOL-2312-G25MLA3	2030699
	Head A: female connector, M23, 12-pin, straight Head B: Flying leads Cable: Incremental, PUR, shielded, 30 m	DOL-2312-G30MLA3	2030702
	Head A: female connector, M23, 12-pin, straight Cable: HIPERFACE®, SSI, Incremental, shielded	DOS-2312-G02	2077057
	Head A: female connector, M23, 12-pin, angled Cable: HIPERFACE®, SSI, Incremental, shielded	DOS-2312-W01	2072580



## SICK AT A GLANCE

SICK is one of the leading manufacturers of intelligent sensors and sensor solutions for industrial applications. A unique range of products and services creates the perfect basis for controlling processes securely and efficiently, protecting individuals from accidents and preventing damage to the environment.

We have extensive experience in a wide range of industries and understand their processes and requirements. With intelligent sensors, we can deliver exactly what our customers need. In application centers in Europe, Asia and North America, system solutions are tested and optimized in accordance with customer specifications. All this makes us a reliable supplier and development partner.

Comprehensive services complete our offering: SICK LifeTime Services provide support throughout the machine life cycle and ensure safety and productivity.

For us, that is “Sensor Intelligence.”

## WORLDWIDE PRESENCE:

Contacts and other locations –[www.sick.com](http://www.sick.com)