



Product designation	Power contactor		
Product type designation	BFK150		
Contact characteristics			
Number of poles	Nr.	3	
Rated insulation voltage U_i IEC/EN	V	690	
Rated impulse withstand voltage U_{imp}	kV	8	
Operational frequency	min	Hz	25
	max	Hz	400
IEC Conventional free air thermal current I_{th}	A	165	
Rated operational power AC-6b ($T \leq 40^\circ C$)	230V	kvar	50
	400V	kvar	100
	440...480V	kvar	115
	690V	kvar	150
Short-time allowable current for 10s (IEC/EN60947-1)	A	1200	
Protection fuse	gG (IEC)	A	160
		A	1500
Making capacity (RMS value)		A	1500
Breaking capacity at voltage	440V	A	1200
	500V	A	1025
	690V	A	905
		m Ω	0.45
Resistance per pole (average value)			
Power dissipation per pole (average value)	I_{th}	W	12
Tightening torque for terminals	min	Nm	6
	max	Nm	7
	min	Ibin	4.4
	max	Ibin	5.2
Tightening torque for coil terminal	min	Nm	0.8
	max	Nm	1
	min	Ibin	0.59
	max	Ibin	0.74
Max number of wires simultaneously connectable	Nr.	2	
Conductor section	AWG/Kcmil	max	2/0
	Flexible w/o lug conductor section	min	mm ² 1.5
max		mm ² 70	
Flexible c/w lug conductor section	min	mm ² 1.5	

		max	mm ²	70
Power terminal protection according to IEC/EN 60529				IP20 front
Mechanical features				
Operating position		normal allowable		Vertical plan ±30°
Fixing				Screw / DIN rail 35mm
Weight			g	2095
Conductor section	AWG/kcmil conductor section	max		2/0
Operations				
Mechanical life			cycles	15000000
Electrical life			cycles	800000
Safety related data				
Performance level B10d according to EN/ISO 13489-1		rated load mechanical load	cycles cycles	400000 15000000
EMC compatibility				yes
AC coil operating				
Rated AC voltage at 60Hz			V	460
AC operating voltage	of 60Hz coil powered at 60Hz pick-up	min max	%Us %Us	80 110
	drop-out	min max	%Us %Us	20 55
AC average coil consumption at 20°C	of 60Hz coil powered at 60Hz	in-rush holding	VA VA	300 20
Dissipation at holding ≤20°C 50Hz			W	6.5
Max cycles frequency				
Mechanical operation			cycles/h	1500
Operating times				
Average time for Us control in AC	Closing NO	min max	ms ms	16 32
	Opening NO	min max	ms ms	9 24
UL technical data				
General USE	Contactor	AC current	A	165
Ambient conditions				
Temperature	Operating temperature			

min	°C	-50
max	°C	70

Storage temperature

min	°C	-60
max	°C	80
	m	3000

Max altitude

Resistance & Protection

Pollution degree

3

Dimensions

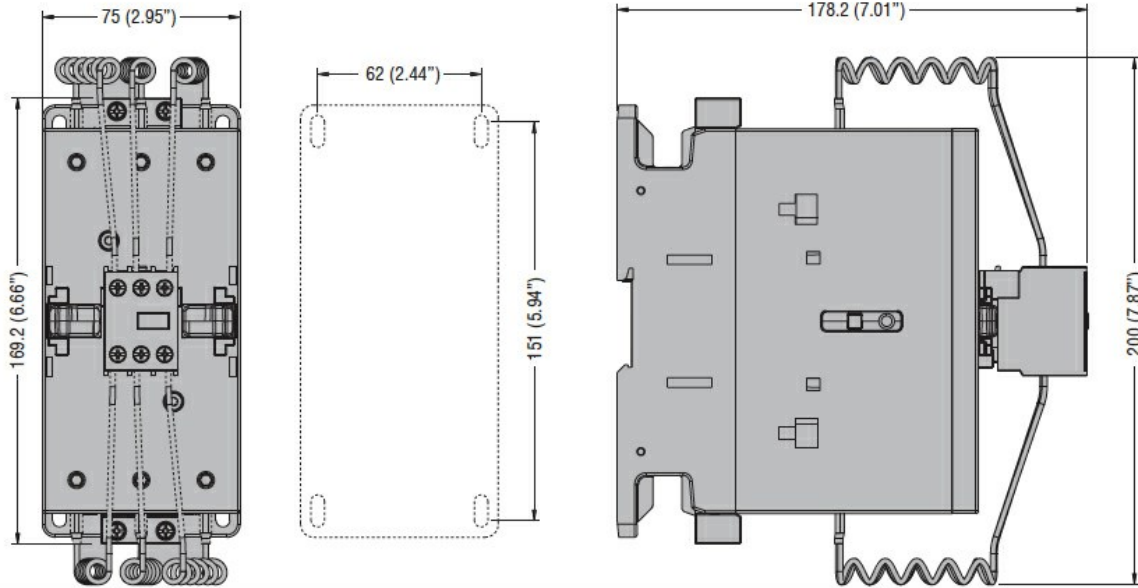

Wiring diagrams

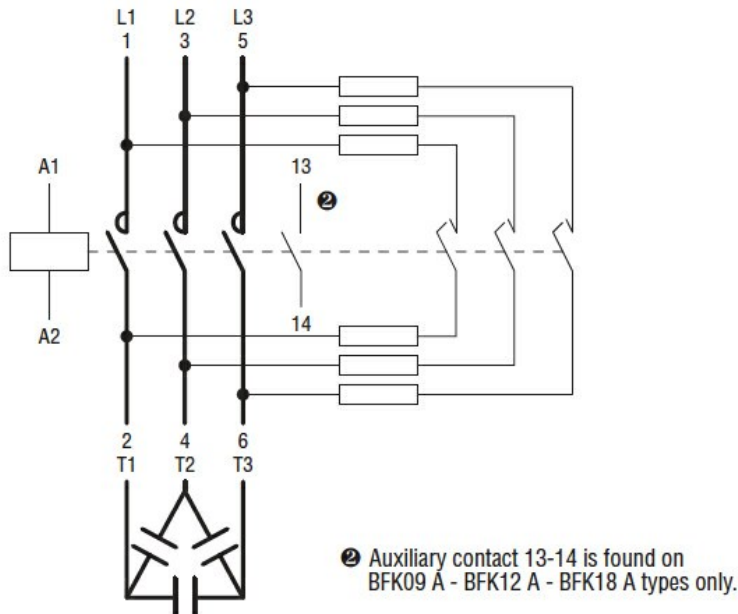

Certifications and compliance

Compliance

CSA C22.2 n° 60947-1

CSA C22.2 n° 60947-4-1

IEC/EN/BS 60947-1

IEC/EN/BS 60947-4-1

UL 60947-1

UL 60947-4-1

Certificates

CCC

cULus

ETIM classification

ETIM 8.0

EC001079 -
Capacitor
contactor