

# LANDA®

illuminotecnica

## IM SERIE 5321 MIRA 65

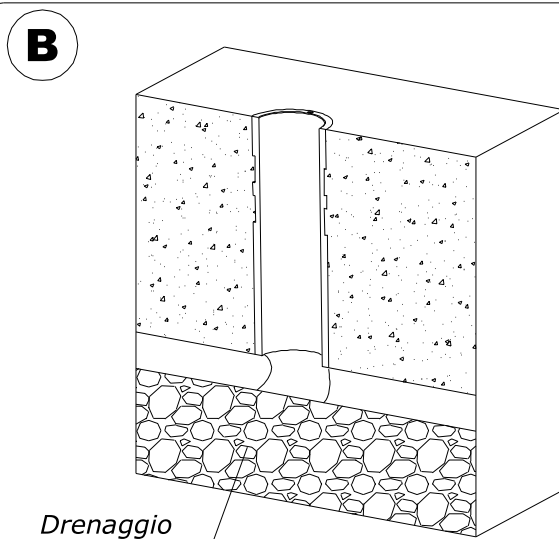
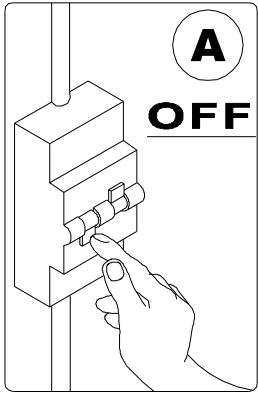
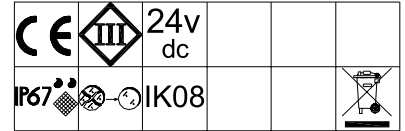

Drenaggio  
Drenaige  
25Cm Min.

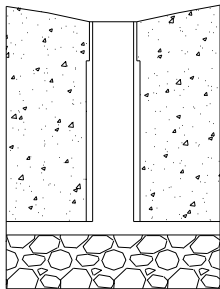

NO

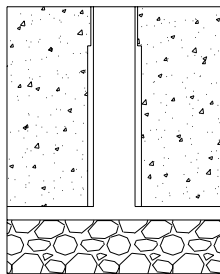

OK

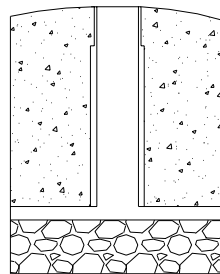

OK

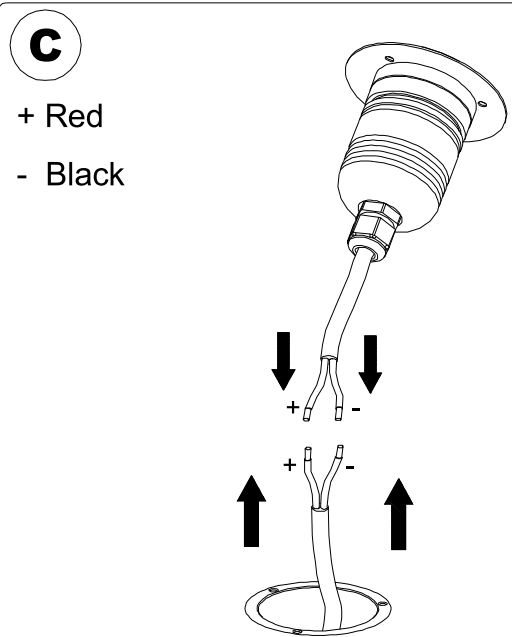

+ Red  
- Black

- Se il cavo flessibile esterno di questo apparecchio viene danneggiato, deve essere sostituito dal costruttore o dal suo servizio assistenza al fine di evitare pericoli. Per il cablaggio dell'apparecchio si dovrà utilizzare un'ideale morsetteria omologata EN 60998-2-1 o EN 60998-2-2 installata in una scatola di cablaggio adeguata con grado di protezione minimo IP67.

- If the external cable of this appliance is damaged, it must be replaced by the manufacturer or its service in order to avoid dangers. For wiring the terminal you should use a suitable approved to EN 60998-2-1 or EN 60998-2-2 installed in a wiring box with adequate minimum degree of protection IP67.

- Si le cordon d'alimentation externe de cet appareil est endommagé, il doit être remplacé par le fabricant ou son service afin d'éviter les dangers. Pour le câblage du terminal, vous devez utiliser un adapté à la norme EN 60998-2-1 approuvés ou EN 60998-2-2 installé dans une boîte de câblage avec un degré minimum adéquat de protection IP67.

- Si el cable de alimentación externa de este aparato está dañado, debe ser reemplazado por el fabricante o su servicio con el fin de evitar los peligros. Para el cableado del terminal debe utilizar un adecuado aprobado a la norma EN 60998-2-1 EN 60998-2-2 o instalados en una caja de cableado, con adecuado grado mínimo de protección IP67.

- Wenn das externe Netzkabel dieses Gerätes beschädigt ist, muss es vom Hersteller oder dem Dienst ersetzt werden, um Gefahren zu vermeiden. Für die Verdrahtung der Klemme sollten Sie eine geeignete zugelassen nach EN 60998-2-1 oder EN 60998-2-2 in einer Anschlussdose mit angemessenen Mindesteinkommen Schutzart IP67 eingebaut

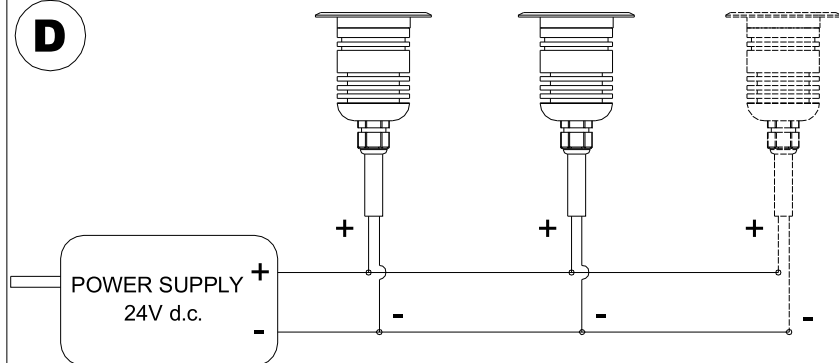

**I**

Questo apparecchio funziona con alimentatori a tensione costante 24v. Il collegamento deve essere effettuato in parallelo (vedi schema sopra). Per l'installazione rivolgersi a personale specializzato.

**UK**

This fixture works with a constant voltage power supply 24V. The connection must be done in parallel (see drawing). For installation contact qualified personnel.

**D**

Diese Gerät läuft mit 24v Konstantstrom. Die Verbindung muß in parallel durchgeführt werden, (siehe das obere Schema). Für die Installation wenden sich ausschließlich an spezialisierten Techniker.

**F**

Cet appareil fonctionne sur des alimentations DC, 24v. La liaison doit être faite en parallèle (voir schéma ci-dessus). Pour l'installation, s'adresser exclusivement à un technicien spécialisé.

**E**

Esta lámpara funciona con alimentador a corriente directa, 24V. El enlace debe ser efectuado en paralelo (véase esquema) Para la instalación dirigirse a personal especializado.

# LANDA®

illuminotecnica

## IM SERIE 5321 MIRA 65

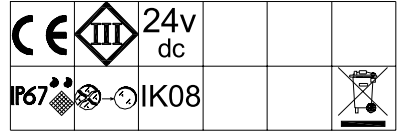

### E

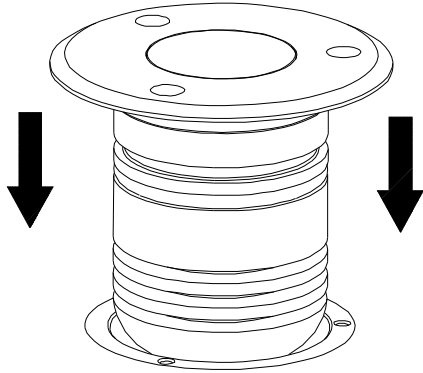

### F

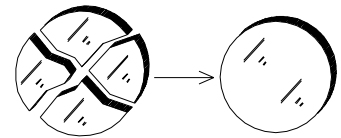
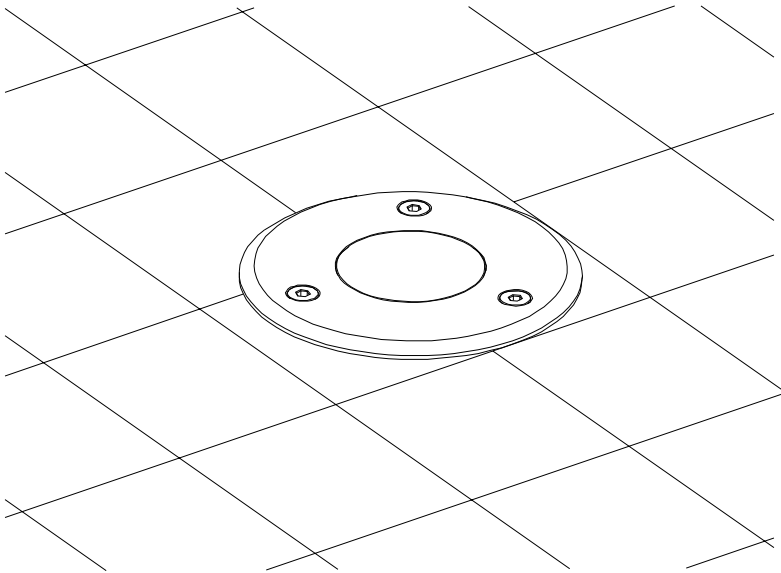
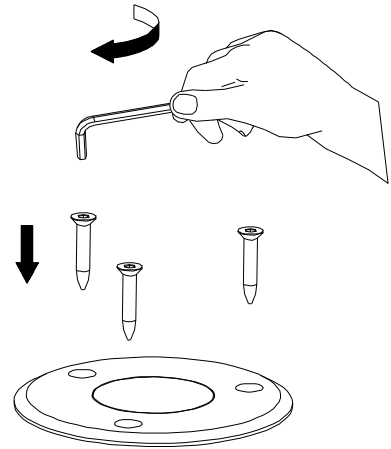

- In caso di rottura del vetro il prodotto non può essere utilizzato , contattare il fornitore per la sua sostituzione .
- Should the glass break , the product cannot be used and you should contact the manufacturer for its replacement .
- En cas d'endommagement de l'écran de protection le produit ne peut pas être utilisé , contactez le fabricant pour le remplacement .
- Falls das Glas kaputt sein sollte, kann das produkt nicht verwendet werden. Kontaktieren Sie in dem Fall den Hersteller, um das Glas zu ersetzen .
- No utilizar el producto en caso de ruptura del vidrio y contactar el fabricante para la sustitución.

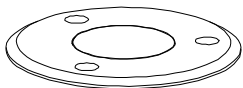

## 5351



Apparecchio calpestabile .  
Walk over fitting .  
Begehbar Leuchten .  
Appareils piétonniers .  
Aparato pisable .



Apparecchio carrabile .  
Drive over fitting .  
Überrollbar .  
Appareils piétonniers .  
Aparato pisable .

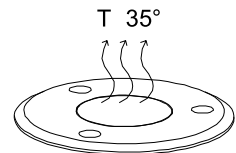
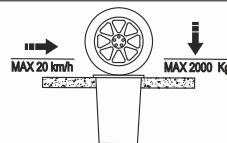

## 5352



Apparecchio carrabile .  
Drive over fitting .  
Überrollbar .  
Appareils piétonniers .  
Aparato pisable .

