



# HTB18-L5C2AH

H18 Sure Sense

HYBRID PHOTOELECTRIC SENSORS

**SICK**  
Sensor Intelligence.



Illustration may differ



### Ordering information

Type	Part no.
HTB18-L5C2AH	1090985

Other models and accessories → [www.sick.com/H18\\_Sure\\_Sense](http://www.sick.com/H18_Sure_Sense)

### Detailed technical data

#### Features

<b>Functional principle</b>	Photoelectric proximity sensor
<b>Functional principle detail</b>	Background suppression
<b>Dimensions (W x H x D)</b>	16.2 mm x 45.5 mm x 34.4 mm
<b>Housing design (light emission)</b>	Hybrid
<b>Thread diameter (housing)</b>	M18
<b>Mounting system type</b>	M18, head/side (24.1 ... 25.4 mm)
<b>Housing color</b>	Blue
<b>Sensing range max.</b>	5 mm ... 300 mm <sup>1)</sup>
<b>Sensing range</b>	5 mm ... 150 mm <sup>2)</sup>
<b>Type of light</b>	Visible red light
<b>Light source</b>	PinPoint LED <sup>3)</sup>
<b>Light spot size (distance)</b>	7 mm (300 mm)
<b>Wave length</b>	631 nm
<b>Adjustment</b>	
	Potentiometer, right Sensing range
	Potentiometer, left Light/dark switching
<b>Special features</b>	-

<sup>1)</sup> Object with 90% remission (based on standard white, DIN 5033).

<sup>2)</sup> Object with 6 % reflectance (referred to standard black, DIN 5033).

<sup>3)</sup> Average service life: 100,000 h at T<sub>J</sub> = +25 °C.

## Mechanics/electronics

<b>Supply voltage</b>	21.6 V DC ... 250 V DC, 96 V AC ... 250 V AC <sup>1)</sup>
<b>Current consumption</b>	≤ 10 mA <sup>2)</sup>
<b>Switching output</b>	MOSFET
<b>Switching mode</b>	Light switching
<b>Switching output detail</b>	
Switching output Q1	MOSFET, Light switching
<b>Output current I<sub>max</sub></b>	≤ 100 mA
<b>Response time</b>	≤ 0.5 ms <sup>3)</sup>
<b>Switching frequency</b>	1,000 Hz <sup>4)</sup>
<b>Connection type</b>	Cable with male connector, micro (1/2"-20), 4-pin, 300 mm
<b>Cable material</b>	PVC
<b>Conductor cross section</b>	0.2 mm <sup>2</sup>
<b>Circuit protection</b>	A <sup>5)</sup> B <sup>6)</sup> D <sup>7)</sup>
<b>Protection class</b>	II <sup>8)</sup>
<b>Weight</b>	18 g
<b>Housing material</b>	Plastic, VISTAL®
<b>Optics material</b>	Plastic, PMMA
<b>Enclosure rating</b>	IP67 IP69K
<b>Items supplied</b>	Fastening nut (1x), M18, plastic, black, flat
<b>Electromagnetic compatibility (EMC)</b>	EN 60947-5-2 (The sensor complies with the Radio Safety Requirements (EMC) for the industrial sector (Radio Safety Class A). It may cause radio interference if used in a residential area.)
<b>Ambient operating temperature</b>	-40 °C ... +65 °C
<b>Ambient temperature, storage</b>	-40 °C ... +75 °C
<b>UL File No.</b>	E189383

<sup>1)</sup> From T<sub>u</sub> 60 °C, max. supply voltage = 120 V.

<sup>2)</sup> Without load. The output load and sensor must use the same power source.

<sup>3)</sup> Signal transit time with resistive load.

<sup>4)</sup> With light/dark ratio 1:1.

<sup>5)</sup> A = V<sub>S</sub> connections reverse-polarity protected.

<sup>6)</sup> B = inputs and output reverse-polarity protected.

<sup>7)</sup> D = outputs overcurrent and short-circuit protected.

<sup>8)</sup> Reference voltage: 250 V AC, overvoltage category 2.

## Safety-related parameters

<b>MTTF<sub>D</sub></b>	393.8 years
<b>DC<sub>avg</sub></b>	0 %

## Classifications

<b>ECLASS 5.0</b>	27270904
<b>ECLASS 5.1.4</b>	27270904
<b>ECLASS 6.0</b>	27270904

<b>ECLASS 6.2</b>	27270904
<b>ECLASS 7.0</b>	27270904
<b>ECLASS 8.0</b>	27270904
<b>ECLASS 8.1</b>	27270904
<b>ECLASS 9.0</b>	27270904
<b>ECLASS 10.0</b>	27270904
<b>ECLASS 11.0</b>	27270904
<b>ECLASS 12.0</b>	27270904
<b>ETIM 5.0</b>	EC002719
<b>ETIM 6.0</b>	EC002719
<b>ETIM 7.0</b>	EC002719
<b>ETIM 8.0</b>	EC002719
<b>UNSPSC 16.0901</b>	39121528

### Connection type/pinouts

<b>Connection type</b>	Cable with male connector, micro (1/2"-20), 4-pin, 300 mm
<b>Connection type Detail</b>	
Conductor cross section	0.2 mm <sup>2</sup>
Cable material	PVC
<b>Pinouts</b>	
RD/BK 1	L1
RD/WH 2	N
RD 3	Q
GN/YE 4	Not connected

**Dimensional drawing** (Dimensions in mm (inch))

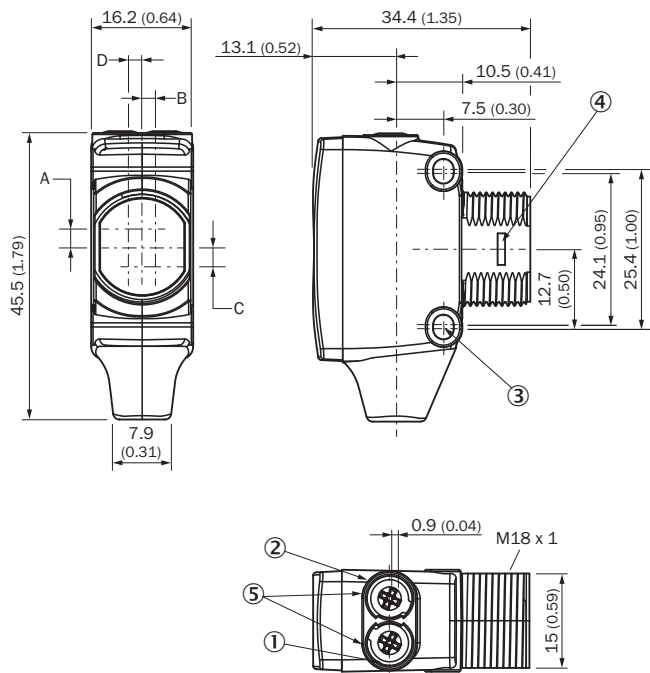

- ① LED indicator yellow: Status of received light beam
- ② LED indicator green: power on
- ③ M3 mounting hole
- ④ Snap Connection for flush ring (sold seperatly)
- ⑤ Potentiometer (if selected) or LED Indicators

Dimensions in mm (inch)	Receiver		Sender	
	A	B	C	D
<b>HTB18 / HTF18</b>	- 1.1 (0.04)	1.1 (0.04)	4.7 (0.19)	0.6 (0.02)
<b>HTE18 / HL18 / HSE18</b>	2.5 (0.1)	0.0 (0.0)	4.0 (0.16)	0.0 (0.0)

**Connection type**

Pinouts, see Technical details: **Connection type/pinouts**

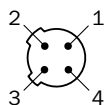

### Characteristic curve

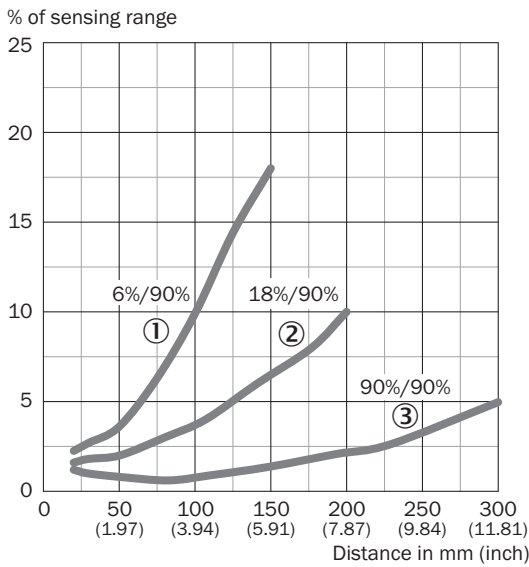

- ① Sensing range on black, 6% remission factor
- ② Sensing range on gray, 18% remission factor
- ③ Sensing range on white, 90% remission factor

### Light spot size

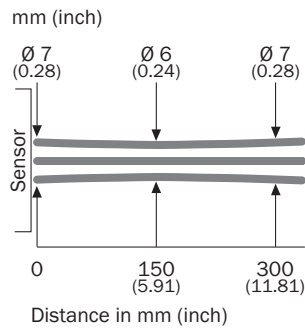

### Sensing range diagram

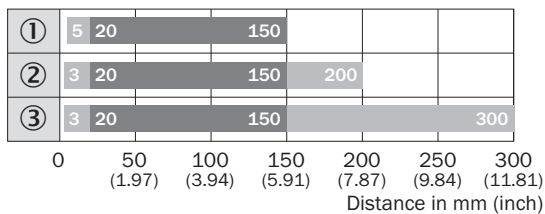

■ Sensing range      ■ Sensing range max.

- ① Sensing range on black, 6% remission factor
- ② Sensing range on gray, 18% remission factor
- ③ Sensing range on white, 90% remission factor

**Functions**

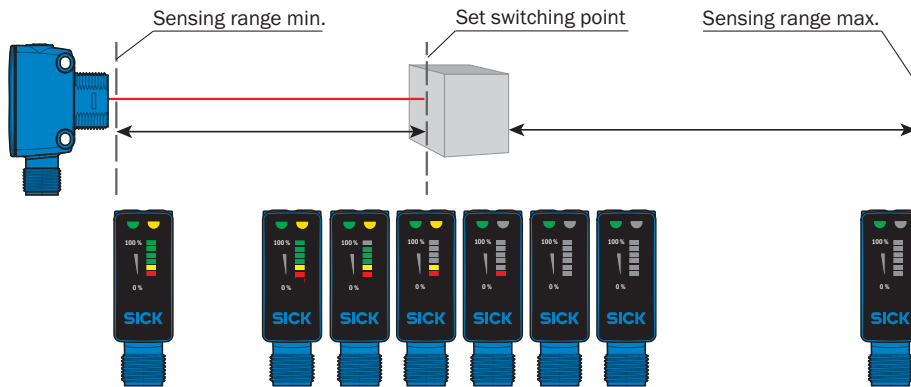

**Recommended accessories**

Other models and accessories → [www.sick.com/H18\\_Sure\\_Sense](http://www.sick.com/H18_Sure_Sense)

	Brief description	Type	Part no.
Others			
	<ul style="list-style-type: none"> <li>• <b>Connection type head A:</b> Female connector, 1/2"-20, 4-pin, straight</li> <li>• <b>Connection type head B:</b> Flying leads</li> <li>• <b>Signal type:</b> Sensor/actuator cable</li> <li>• <b>Cable:</b> 2 m, 4-wire, PVC</li> <li>• <b>Description:</b> Sensor/actuator cable</li> <li>• <b>Connection systems:</b> Flying leads</li> </ul>	KA24-SIF22	7023591

## SICK AT A GLANCE

SICK is one of the leading manufacturers of intelligent sensors and sensor solutions for industrial applications. A unique range of products and services creates the perfect basis for controlling processes securely and efficiently, protecting individuals from accidents and preventing damage to the environment.

We have extensive experience in a wide range of industries and understand their processes and requirements. With intelligent sensors, we can deliver exactly what our customers need. In application centers in Europe, Asia and North America, system solutions are tested and optimized in accordance with customer specifications. All this makes us a reliable supplier and development partner.

Comprehensive services complete our offering: SICK LifeTime Services provide support throughout the machine life cycle and ensure safety and productivity.

For us, that is “Sensor Intelligence.”

## WORLDWIDE PRESENCE:

Contacts and other locations –[www.sick.com](http://www.sick.com)