

CORNIERE COR 24 / 48
COR 24 / 48 ANGLE

GC
HDG

legrand | CABLE
MANAGEMENT

FT0260-3

02 16

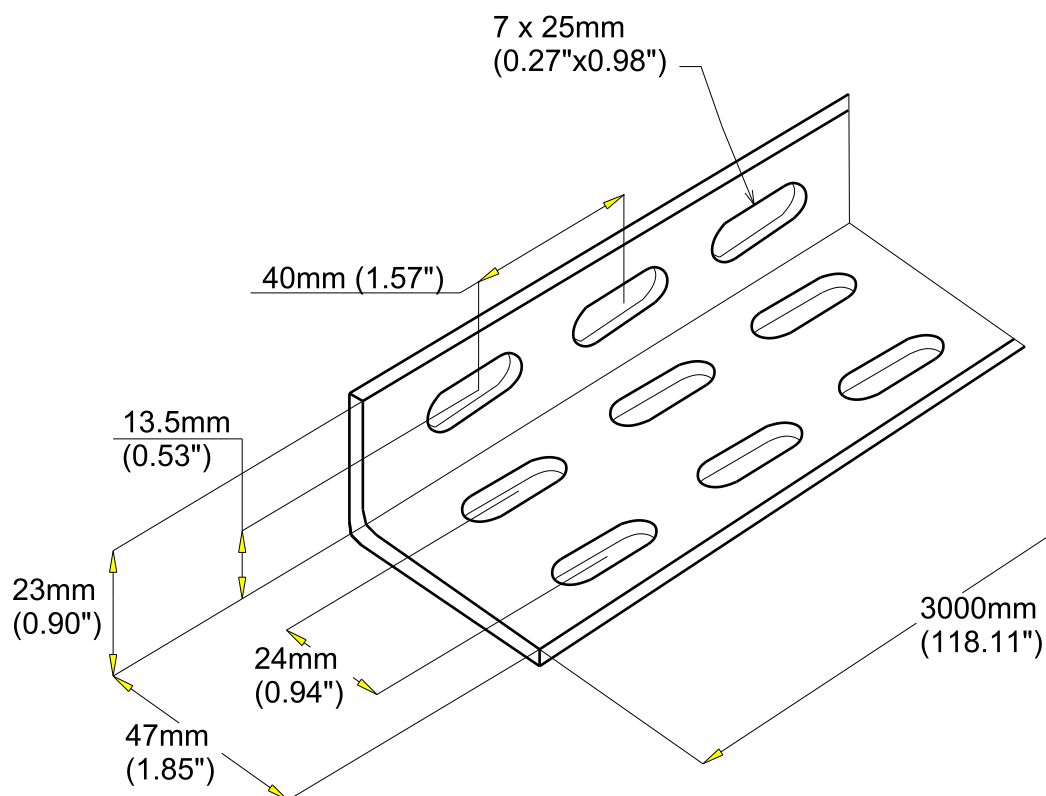

Material	Standard	Finishes	Standard
S235JR	EN 10025	Hot dip galvanized	EN ISO 1461

REF	CODE	POIDS (Kg/m)	WEIGHT (lb/ft)
COR 24/48	524 191	0.760	0.511

EPAISSEUR / THICKNESS
1.5 / (0.06")