

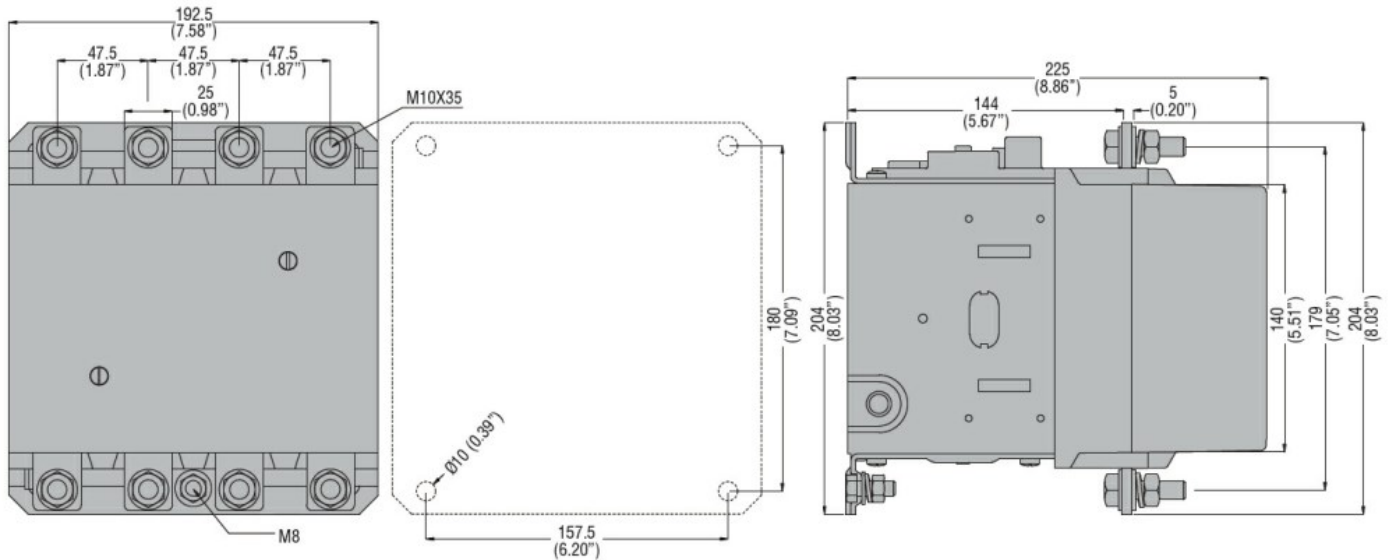

Contact characteristics

Number of poles	Nr.	4
Operational current Ie	AC-4 (400V)	A 115
Making capacity (RMS value)	A	2750
Breaking capacity at voltage	440V	A 2500
	500V	A 2250
	690V	A 2200

Dimensions



Wiring diagrams

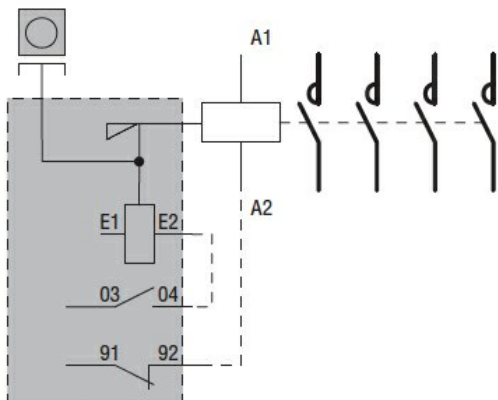

Certifications and compliance

Compliance

- CSA C22.2 n° 60947-1
- CSA C22.2 n° 60947-4-1
- IEC/EN 60947-1

IEC/EN 60947-4-1

UL 60947-1

UL 60947-4-1

Certificates

CCC

cULus

EAC