



HTE18-N2B1BH

H18 Sure Sense

HYBRID PHOTOELECTRIC SENSORS

SICK
Sensor Intelligence.



Illustration may differ



Ordering information

Type	Part no.
HTE18-N2B1BH	1081110

Other models and accessories → www.sick.com/H18_Sure_Sense

Detailed technical data

Features

Functional principle	Photoelectric proximity sensor				
Functional principle detail	Energetic				
Dimensions (W x H x D)	16.2 mm x 45.5 mm x 31.8 mm				
Housing design (light emission)	Hybrid				
Thread diameter (housing)	M18				
Mounting system type	M18, head/side (24.1 ... 25.4 mm)				
Housing color	Blue				
Sensing range max.	5 mm ... 1,000 mm ¹⁾				
Sensing range	10 mm ... 250 mm ²⁾				
Type of light	Infrared light				
Light source	LED ³⁾				
Light spot size (distance)	110 mm (800 mm)				
Wave length	850 nm				
Adjustment	<table border="0"> <tr> <td>Potentiometer, right</td> <td>Sensitivity</td> </tr> <tr> <td>Potentiometer, left</td> <td>Light/dark switching</td> </tr> </table>	Potentiometer, right	Sensitivity	Potentiometer, left	Light/dark switching
Potentiometer, right	Sensitivity				
Potentiometer, left	Light/dark switching				
Special features	Signal strength light bar				

¹⁾ Object with 90% remission (based on standard white, DIN 5033).

²⁾ Object with 6 % reflectance (referred to standard black, DIN 5033).

³⁾ Average service life: 100,000 h at T_U = +25 °C.

Mechanics/electronics

Supply voltage	10 V DC ... 30 V DC
Ripple	$< 5 V_{pp}^{1)}$
Current consumption	$\leq 20 \text{ mA}^{2)}$
Switching output	NPN
Switching mode	Light switching
Switching output detail	
Switching output Q1	NPN, Light switching
Switching output Q2	Not connected
Output current I_{max}	$\leq 100 \text{ mA}$
Response time	$\leq 0.5 \text{ ms}^{3)}$
Switching frequency	1,000 Hz ⁴⁾
Connection type	Cable with connector M8, 3-pin, 150 mm
Cable material	PVC
Conductor cross section	0.2 mm ²
Circuit protection	A ⁵⁾ B ⁶⁾ D ⁷⁾
Protection class	III
Weight	18 g
Housing material	Plastic, VISTAL®
Optics material	Plastic, PMMA
Enclosure rating	IP67 IP69K
Items supplied	Fastening nut (1x), M18, plastic, black, flat
Electromagnetic compatibility (EMC)	EN 60947-5-2 (The sensor complies with the Radio Safety Requirements (EMC) for the industrial sector (Radio Safety Class A). It may cause radio interference if used in a residential area.)
Ambient operating temperature	-40 °C ... +70 °C
Ambient temperature, storage	-40 °C ... +75 °C
UL File No.	E189383

¹⁾ May not exceed or fall below U_v tolerances.

²⁾ Without signal strength light bar and load.

³⁾ Signal transit time with resistive load.

⁴⁾ With light/dark ratio 1:1.

⁵⁾ A = V_S connections reverse-polarity protected.

⁶⁾ B = inputs and output reverse-polarity protected.

⁷⁾ D = outputs overcurrent and short-circuit protected.

Safety-related parameters

MTTF_D	681.6 years
DC_{avg}	0 %

Classifications

ECLASS 5.0	27270903
ECLASS 5.1.4	27270903

ECLASS 6.0	27270903
ECLASS 6.2	27270903
ECLASS 7.0	27270903
ECLASS 8.0	27270903
ECLASS 8.1	27270903
ECLASS 9.0	27270903
ECLASS 10.0	27270903
ECLASS 11.0	27270903
ECLASS 12.0	27270903
ETIM 5.0	EC002719
ETIM 6.0	EC002719
ETIM 7.0	EC002719
ETIM 8.0	EC002719
UNSPSC 16.0901	39121528

Connection type/pinouts

Connection type	Cable with connector M8, 3-pin, 150 mm
Connection type Detail	
Conductor cross section	0.2 mm ²
Cable material	PVC
Pinouts	
BN 1	+ (L+)
BU 3	- (M)
BK 4	Q

Dimensional drawing (Dimensions in mm (inch))



- ① LED indicator yellow: Status of received light beam
- ② LED indicator green: power on
- ③ M3 mounting hole
- ④ Snap Connection for flush ring (sold seperatly)
- ⑤ Potentiometer (if selected) or LED Indicators

Dimensions in mm (inch)	Receiver		Sender	
	A	B	C	D
HTB18 / HTF18	- 1.1 (0.04)	1.1 (0.04)	4.7 (0.19)	0.6 (0.02)
HTE18 / HL18 / HSE18	2.5 (0.1)	0.0 (0.0)	4.0 (0.16)	0.0 (0.0)
HTB18L / HTF18L / HL18L / HSE18L	2.5 (0.1)	0.0 (0.0)	3.5 (0.14)	0.0 (0.0)

Connection type

Pinouts, see Technical details: **Connection type/pinouts**

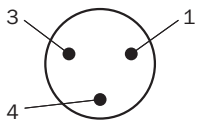

Connector M8, 3-pin

Adjustments possible



- ① LED indicator yellow: Status of received light beam
- ② LED indicator green: power on
- ③ Signal strength light bar

Characteristic curve

Infrared light

Operating reserve

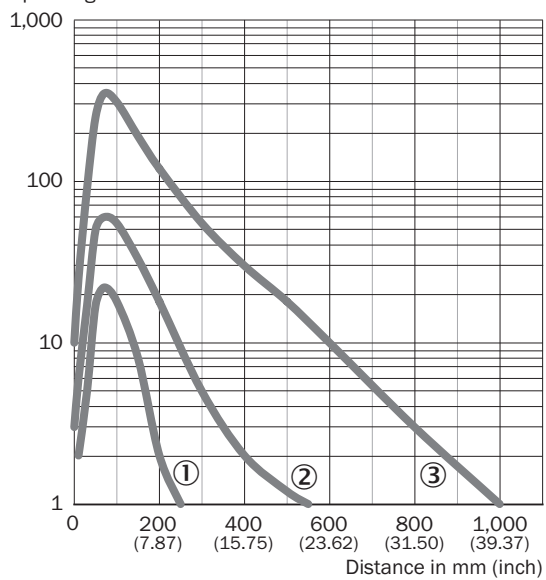

- ① Sensing range on black, 6% remission factor
- ② Sensing range on gray, 18% remission factor
- ③ Sensing range on white, 90% remission factor

Light spot size

Infrared light

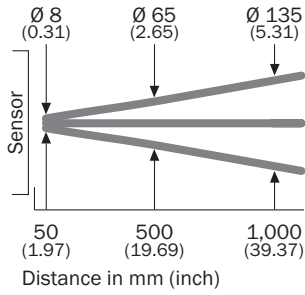

Sensing range diagram

Infrared light

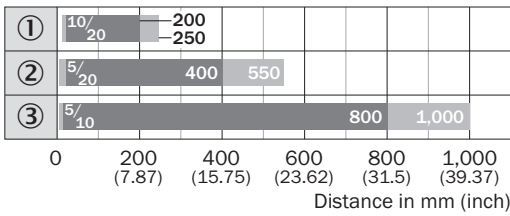

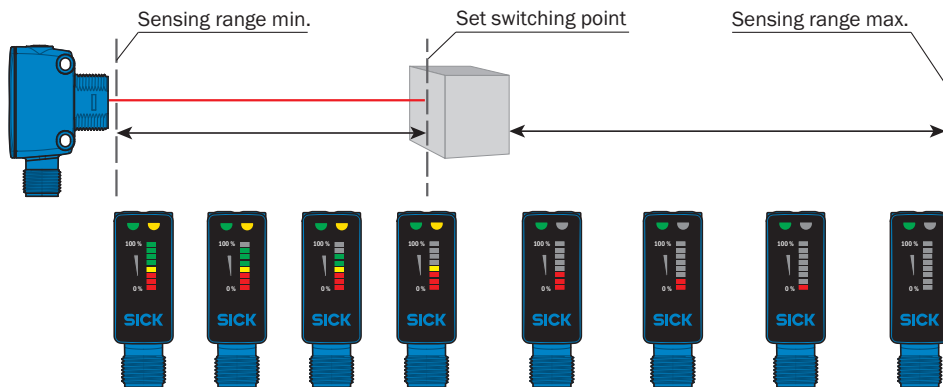

- Sensing range ■ Sensing range max.
- ① Sensing range on black, 6% remission factor
- ② Sensing range on gray, 18% remission factor
- ③ Sensing range on white, 90% remission factor

Functions



Recommended accessories

Other models and accessories → www.sick.com/H18_Sure_Sense

	Brief description	Type	Part no.
Plug connectors and cables			
	<ul style="list-style-type: none"> • Connection type head A: Male connector, M8, 3-pin, straight • Description: Unshielded • Connection systems: Screw-type terminals • Permitted cross-section: 0.14 mm² ... 0.5 mm² 	STE-0803-G	6037322
Others			
	<ul style="list-style-type: none"> • Connection type head A: Female connector, M8, 3-pin, straight, A-coded • Connection type head B: Flying leads • Signal type: Sensor/actuator cable • Cable: 5 m, 3-wire, PVC • Description: Sensor/actuator cable, unshielded • Application: Zones with chemicals 	YF8U13-050VA1XLEAX	2095884

SICK AT A GLANCE

SICK is one of the leading manufacturers of intelligent sensors and sensor solutions for industrial applications. A unique range of products and services creates the perfect basis for controlling processes securely and efficiently, protecting individuals from accidents and preventing damage to the environment.

We have extensive experience in a wide range of industries and understand their processes and requirements. With intelligent sensors, we can deliver exactly what our customers need. In application centers in Europe, Asia and North America, system solutions are tested and optimized in accordance with customer specifications. All this makes us a reliable supplier and development partner.

Comprehensive services complete our offering: SICK LifeTime Services provide support throughout the machine life cycle and ensure safety and productivity.

For us, that is “Sensor Intelligence.”

WORLDWIDE PRESENCE:

Contacts and other locations –www.sick.com