

Enna Twin

astro

General

Location:	Interior
Class:	CE (Class I)
Ip Rating:	IP20
Bathroom Zone:	-
Driver Required:	No
Installation Orientation:	Wall Mount - Horizontal
Main Material:	Metal - Zinc
Dimensions (mm):	H: 114 W: 225 D: 86
Cut Out Hole :	-
Recess Depth (mm):	-
Fire Rating:	-
Cable Length (mm):	-
Gross Weight (kg):	1.18

Lamp

Light Source:	High Powered LED
Wattage:	6.6W
Lamp Included:	Yes (Integral)
Maximum Lamp Length (mm):	-
Luminous Flux (lm):	340
Colour Temp (K):	2700
Cri (Ra):	90
Macadam Ellipse:	3-Step
Tilt Adjustable Angle (°):	90
Rotation Adjustable Angle (°):	330
Lifetime (hrs):	51000
Beam Angle (°):	38

Electrical

Switched:	Yes
Dimmable:	No
Dimming Method:	-
Supply Frequency (Hz):	50-60
Driver/Ballast Voltage (V):	100-240
Driver Lifetime (hrs):	100000
Efficacy (lm/W):	52

Additional Information:

Shade Included:	-
Shade/Diffuser Material:	-
Shade/Diffuser Finish:	-
F Mark:	Suitable for mounting on flammable materials



CODE: 1058192
FINISH: MATT BLACK



CODE: 1058194
FINISH: MATT WHITE



CODE: 1058195
FINISH: MATT NICKEL



CODE: 1058196
FINISH: MATT GOLD



CODE: 1058197
FINISH: BRONZE

To maintain this product to its best condition, please view our care and cleaning guide on the support section of the astro website.

Pour entretenir au mieux ce produit, veuillez consulter notre guide d'entretien et de nettoyage, dans la rubrique d'aide sur le site Web d'Astro.

Um dieses Produkt im besten Zustand zu erhalten, beachten Sie bitte unseren Leitfaden zu Pflege und Reinigung im Abschnitt „Support“ auf der Astro-Website.

Per mantenere questo prodotto nelle sue migliori condizioni, consultare la nostra guida per la manutenzione e la pulizia nella sezione dedicata all'assistenza del sito Web Astro.

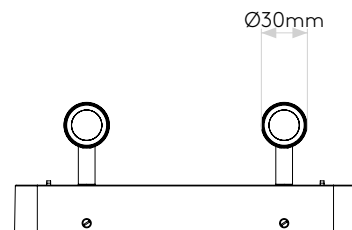
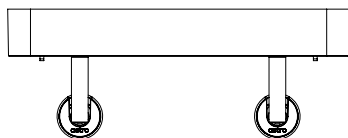
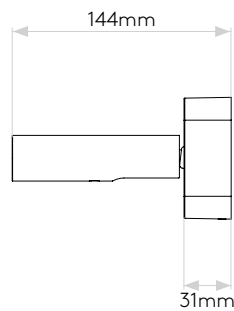
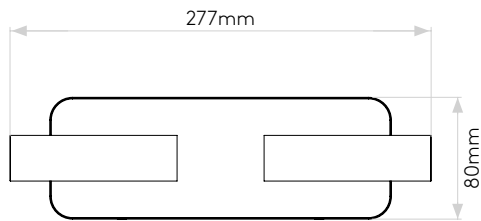
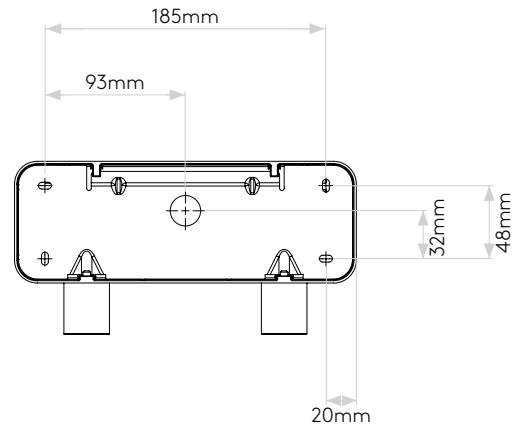
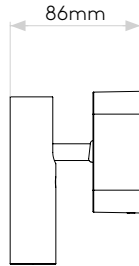
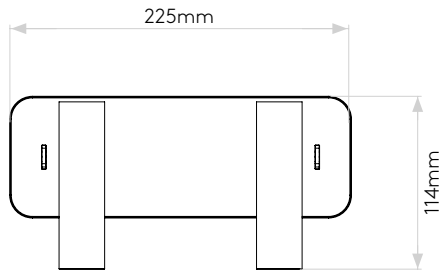

Please note that some dimensions may vary slightly due to manufacturing tolerances, this includes cable entry and fixing holes

Veillez noter que certaines dimensions peuvent varier légèrement en raison des tolérances de fabrication, y compris l'entrée de câble et les trous de fixation.

Bitte beachten Sie, dass die Maße Fertigungstoleranzen unterliegen und daher in geringem Umfang von der angegebenen Größe abweichen können. Dies gilt auch für Kabeingänge und Befestigungslöcher.

Si prega notare che possono esserci piccole variazioni in alcune dimensioni dovute alle tolleranze di produzione, queste includono l'ingresso del cavo e i fori di fissaggio.