

Modicon TMC4

Cartridges

Hardware Guide

05/2019

EIO0000003113.00

www.schneider-electric.com



The information provided in this documentation contains general descriptions and/or technical characteristics of the performance of the products contained herein. This documentation is not intended as a substitute for and is not to be used for determining suitability or reliability of these products for specific user applications. It is the duty of any such user or integrator to perform the appropriate and complete risk analysis, evaluation and testing of the products with respect to the relevant specific application or use thereof. Neither Schneider Electric nor any of its affiliates or subsidiaries shall be responsible or liable for misuse of the information contained herein. If you have any suggestions for improvements or amendments or have found errors in this publication, please notify us.

You agree not to reproduce, other than for your own personal, noncommercial use, all or part of this document on any medium whatsoever without permission of Schneider Electric, given in writing. You also agree not to establish any hypertext links to this document or its content. Schneider Electric does not grant any right or license for the personal and noncommercial use of the document or its content, except for a non-exclusive license to consult it on an "as is" basis, at your own risk. All other rights are reserved.

All pertinent state, regional, and local safety regulations must be observed when installing and using this product. For reasons of safety and to help ensure compliance with documented system data, only the manufacturer should perform repairs to components.

When devices are used for applications with technical safety requirements, the relevant instructions must be followed.

Failure to use Schneider Electric software or approved software with our hardware products may result in injury, harm, or improper operating results.

Failure to observe this information can result in injury or equipment damage.

© 2019 Schneider Electric. All rights reserved.

Table of Contents



	Safety Information	5
	About the Book	7
Part I	TMC4 General Overview	13
Chapter 1	TMC4 Description	15
	General Description	15
Chapter 2	TMC4 Installation	17
2.1	TMC4 General Rules for Implementing	18
	Environmental Characteristics	19
	Certifications and Standards	20
2.2	TMC4 Installation	21
	Installation and Maintenance Requirements	22
	TMC4 Installation	24
2.3	TMC4 Electrical Requirements	31
	Wiring Best Practices	32
	Grounding the M241 System	35
Part II	TMC4 Standard Cartridges	39
Chapter 3	TMC4AI2 Analog Voltage/Current Inputs	41
	TMC4AI2 Presentation	42
	TMC4AI2 Characteristics	44
	TMC4AI2 Wiring Diagram	46
Chapter 4	TMC4TI2 Analog Temperature Inputs	47
	TMC4TI2 Presentation	48
	TMC4TI2 Characteristics	50
	TMC4TI2 Wiring Diagram	53
Chapter 5	TMC4AQ2 Analog Voltage/Current Outputs	55
	TMC4AQ2 Presentation	56
	TMC4AQ2 Characteristics	58
	TMC4AQ2 Wiring Diagram	60
Part III	TMC4 Application Cartridges	61
Chapter 6	TMC4HOIS01 Hoisting	63
	TMC4HOIS01 Presentation	64
	TMC4HOIS01 Characteristics	66
	TMC4HOIS01 Wiring Diagram	68

Chapter 7	TMC4PACK01 Packaging	69
	TMC4PACK01 Presentation	70
	TMC4PACK01 Characteristics	72
	TMC4PACK01 Wiring Diagram	74
Glossary	75
Index	77

Safety Information



Important Information

NOTICE

Read these instructions carefully, and look at the equipment to become familiar with the device before trying to install, operate, service, or maintain it. The following special messages may appear throughout this documentation or on the equipment to warn of potential hazards or to call attention to information that clarifies or simplifies a procedure.



The addition of this symbol to a “Danger” or “Warning” safety label indicates that an electrical hazard exists which will result in personal injury if the instructions are not followed.



This is the safety alert symbol. It is used to alert you to potential personal injury hazards. Obey all safety messages that follow this symbol to avoid possible injury or death.

DANGER

DANGER indicates a hazardous situation which, if not avoided, **will result in** death or serious injury.

WARNING

WARNING indicates a hazardous situation which, if not avoided, **could result in** death or serious injury.

CAUTION

CAUTION indicates a hazardous situation which, if not avoided, **could result in** minor or moderate injury.

NOTICE

NOTICE is used to address practices not related to physical injury.

PLEASE NOTE

Electrical equipment should be installed, operated, serviced, and maintained only by qualified personnel. No responsibility is assumed by Schneider Electric for any consequences arising out of the use of this material.

A qualified person is one who has skills and knowledge related to the construction and operation of electrical equipment and its installation, and has received safety training to recognize and avoid the hazards involved.

QUALIFICATION OF PERSONNEL

Only appropriately trained persons who are familiar with and understand the contents of this manual and all other pertinent product documentation are authorized to work on and with this product.

The qualified person must be able to detect possible hazards that may arise from parameterization, modifying parameter values and generally from mechanical, electrical, or electronic equipment. The qualified person must be familiar with the standards, provisions, and regulations for the prevention of industrial accidents, which they must observe when designing and implementing the system.

INTENDED USE

The products described or affected by this document, together with software, accessories, and options, are cartridges, intended for industrial use according to the instructions, directions, examples, and safety information contained in the present document and other supporting documentation.

The product may only be used in compliance with all applicable safety regulations and directives, the specified requirements, and the technical data.

Prior to using the product, you must perform a risk assessment in view of the planned application. Based on the results, the appropriate safety-related measures must be implemented.

Since the product is used as a component in an overall machine or process, you must ensure the safety of persons by means of the design of this overall system.

Operate the product only with the specified cables and accessories. Use only genuine accessories and spare parts.

Any use other than the use explicitly permitted is prohibited and can result in unanticipated hazards.

About the Book



At a Glance

Document Scope

This guide describes the hardware implementation of TMC4. It provides the parts description, characteristics, wiring diagrams, and installation details for TMC4.

Validity Note

The information in this manual is applicable **only** for TMC4 products.

This document has been updated for the release of EcoStruxure™ Machine Expert V1.1.

For product compliance and environmental information (RoHS, REACH, PEP, EOLI, etc.), go to www.schneider-electric.com/green-premium.

The technical characteristics of the devices described in the present document also appear online. To access the information online:

Step	Action
1	Go to the Schneider Electric home page www.schneider-electric.com .
2	In the Search box type the reference of a product or the name of a product range. <ul style="list-style-type: none">● Do not include blank spaces in the reference or product range.● To get information on grouping similar modules, use asterisks (*).
3	If you entered a reference, go to the Product Datasheets search results and click on the reference that interests you. If you entered the name of a product range, go to the Product Ranges search results and click on the product range that interests you.
4	If more than one reference appears in the Products search results, click on the reference that interests you.
5	Depending on the size of your screen, you may need to scroll down to see the datasheet.
6	To save or print a datasheet as a .pdf file, click Download XXX product datasheet .

The characteristics that are presented in the present document should be the same as those characteristics that appear online. In line with our policy of constant improvement, we may revise content over time to improve clarity and accuracy. If you see a difference between the document and online information, use the online information as your reference.

Related Documents

Title of Documentation	Reference Number
Modicon TMC4 Cartridges - Programming Guide	<i>EIO0000003107 (ENG)</i> <i>EIO0000003108 (FRE)</i> <i>EIO0000003109 (GER)</i> <i>EIO0000003110 (SPA)</i> <i>EIO0000003111 (ITA)</i> <i>EIO0000003112 (CHS)</i>
Modicon M241 Logic Controller - Hardware Guide	<i>EIO0000003083 (ENG)</i> <i>EIO0000003084 (FRE)</i> <i>EIO0000003085 (GER)</i> <i>EIO0000003086 (SPA)</i> <i>EIO0000003087 (ITA)</i> <i>EIO0000003088 (CHS)</i>

You can download these technical publications and other technical information from our website at <https://www.schneider-electric.com/en/download>

Product Related Information

DANGER

HAZARD OF ELECTRIC SHOCK, EXPLOSION OR ARC FLASH

- Disconnect all power from all equipment including connected devices prior to removing any covers or doors, or installing or removing any accessories, hardware, cables, or wires except under the specific conditions specified in the appropriate hardware guide for this equipment.
- Always use a properly rated voltage sensing device to confirm the power is off where and when indicated.
- Replace and secure all covers, accessories, hardware, cables, and wires and confirm that a proper ground connection exists before applying power to the unit.
- Use only the specified voltage when operating this equipment and any associated products.

Failure to follow these instructions will result in death or serious injury.

DANGER

POTENTIAL FOR EXPLOSION

- Only use this equipment in non-hazardous locations, or in locations that comply with Class I, Division 2, Groups A, B, C and D.
- Do not substitute components which would impair compliance to Class I, Division 2.
- Do not connect or disconnect equipment unless power has been removed or the location is known to be non-hazardous.
- Do not use the USB port(s), if so equipped, unless the location is known to be non-hazardous.

Failure to follow these instructions will result in death or serious injury.

WARNING

LOSS OF CONTROL

- The designer of any control scheme must consider the potential failure modes of control paths and, for certain critical control functions, provide a means to achieve a safe state during and after a path failure. Examples of critical control functions are emergency stop and overtravel stop, power outage and restart.
- Separate or redundant control paths must be provided for critical control functions.
- System control paths may include communication links. Consideration must be given to the implications of unanticipated transmission delays or failures of the link.
- Observe all accident prevention regulations and local safety guidelines.¹
- Each implementation of this equipment must be individually and thoroughly tested for proper operation before being placed into service.

Failure to follow these instructions can result in death, serious injury, or equipment damage.

¹ For additional information, refer to NEMA ICS 1.1 (latest edition), "Safety Guidelines for the Application, Installation, and Maintenance of Solid State Control" and to NEMA ICS 7.1 (latest edition), "Safety Standards for Construction and Guide for Selection, Installation and Operation of Adjustable-Speed Drive Systems" or their equivalent governing your particular location.

WARNING

UNINTENDED EQUIPMENT OPERATION

- Only use software approved by Schneider Electric for use with this equipment.
- Update your application program every time you change the physical hardware configuration.

Failure to follow these instructions can result in death, serious injury, or equipment damage.

Terminology Derived from Standards

The technical terms, terminology, symbols and the corresponding descriptions in this manual, or that appear in or on the products themselves, are generally derived from the terms or definitions of international standards.

In the area of functional safety systems, drives and general automation, this may include, but is not limited to, terms such as *safety*, *safety function*, *safe state*, *fault*, *fault reset*, *malfunction*, *failure*, *error*, *error message*, *dangerous*, etc.

Among others, these standards include:

Standard	Description
IEC 61131-2:2007	Programmable controllers, part 2: Equipment requirements and tests.
ISO 13849-1:2015	Safety of machinery: Safety related parts of control systems. General principles for design.
EN 61496-1:2013	Safety of machinery: Electro-sensitive protective equipment. Part 1: General requirements and tests.
ISO 12100:2010	Safety of machinery - General principles for design - Risk assessment and risk reduction
EN 60204-1:2006	Safety of machinery - Electrical equipment of machines - Part 1: General requirements
ISO 14119:2013	Safety of machinery - Interlocking devices associated with guards - Principles for design and selection
ISO 13850:2015	Safety of machinery - Emergency stop - Principles for design
IEC 62061:2015	Safety of machinery - Functional safety of safety-related electrical, electronic, and electronic programmable control systems
IEC 61508-1:2010	Functional safety of electrical/electronic/programmable electronic safety-related systems: General requirements.
IEC 61508-2:2010	Functional safety of electrical/electronic/programmable electronic safety-related systems: Requirements for electrical/electronic/programmable electronic safety-related systems.
IEC 61508-3:2010	Functional safety of electrical/electronic/programmable electronic safety-related systems: Software requirements.
IEC 61784-3:2016	Industrial communication networks - Profiles - Part 3: Functional safety fieldbuses - General rules and profile definitions.
2006/42/EC	Machinery Directive
2014/30/EU	Electromagnetic Compatibility Directive
2014/35/EU	Low Voltage Directive

In addition, terms used in the present document may tangentially be used as they are derived from other standards such as:

Standard	Description
IEC 60034 series	Rotating electrical machines
IEC 61800 series	Adjustable speed electrical power drive systems
IEC 61158 series	Digital data communications for measurement and control – Fieldbus for use in industrial control systems

Finally, the term *zone of operation* may be used in conjunction with the description of specific hazards, and is defined as it is for a *hazard zone* or *danger zone* in the *Machinery Directive (2006/42/EC)* and *ISO 12100:2010*.

NOTE: The aforementioned standards may or may not apply to the specific products cited in the present documentation. For more information concerning the individual standards applicable to the products described herein, see the characteristics tables for those product references.

Part I

TMC4 General Overview

What Is in This Part?

This part contains the following chapters:

Chapter	Chapter Name	Page
1	TMC4 Description	15
2	TMC4 Installation	17

Chapter 1

TMC4 Description

General Description

Introduction

The cartridges are designed to be connected to the Modicon M241 Logic Controller range.

Cartridges Features

The following table describes the TMC4 cartridges features:

Reference	Description
TMC4AI2 <i>(see page 41)</i>	TMC4 cartridge with 2 analog voltage or current inputs (0...10 V, 0...20 mA, 4...20 mA), 12 bits
TMC4TI2 <i>(see page 47)</i>	TMC4 cartridge with 2 analog temperature inputs (thermocouple, RTD), 14 bits
TMC4AQ2 <i>(see page 55)</i>	TMC4 cartridge with 2 analog voltage or current outputs (0...10 V, 4...20 mA), 16 bits
TMC4HOIS01 <i>(see page 63)</i>	TMC4 application cartridge with 2 analog voltage or current inputs for hoisting load cells
TMC4PACK01 <i>(see page 69)</i>	TMC4 application cartridge with 2 analog voltage or current inputs for packaging

Logic Controller Compatibility

NOTE: For more information on cartridge compatibility with specific controllers, refer to your controller-specific hardware guide.

The following table describes the number of TMC4 cartridges that can be installed in a Modicon M241 Logic Controller:

Reference	Cartridge Slots
TM241C24R	1
TM241CE24R	1
TM241CEC24R	1
TM241C24T	1
TM241CE24T	1
TM241CEC24T	1
TM241C24U	1
TM241CE24U	1
TM241CEC24U	1
TM241C40R	2
TM241CE40R	2
TM241C40T	2
TM241CE40T	2
TM241C40U	2
TM241CE40U	2

NOTICE

ELECTROSTATIC DISCHARGE

- Verify that empty cartridge slots have their covers in place before applying power to the controller.
- Do not touch the contacts of the cartridge.
- Only handle the cartridge on the housing.
- Take the necessary protective measures against electrostatic discharges.

Failure to follow these instructions can result in equipment damage.

Chapter 2

TMC4 Installation

What Is in This Chapter?

This chapter contains the following sections:

Section	Topic	Page
2.1	TMC4 General Rules for Implementing	18
2.2	TMC4 Installation	21
2.3	TMC4 Electrical Requirements	31

Section 2.1

TMC4 General Rules for Implementing

What Is in This Section?

This section contains the following topics:

Topic	Page
Environmental Characteristics	19
Certifications and Standards	20

Environmental Characteristics

TMC4

TMC4 cartridge environmental characteristics are the same as the Modicon M241 Logic Controller (*see Modicon M241 Logic Controller, Hardware Guide*).

Certifications and Standards

Introduction

The M241 Logic Controllers are designed to conform to the main national and international standards concerning electronic industrial control devices:

- IEC/EN 61131-2
- UL 508

The M241 Logic Controllers have obtained the following conformity marks:

- CE
- cULus
- CSA

For product compliance and environmental information (RoHS, REACH, PEP, EOL, etc.), go to www.schneider-electric.com/green-premium.

Section 2.2

TMC4 Installation

What Is in This Section?

This section contains the following topics:

Topic	Page
Installation and Maintenance Requirements	22
TMC4 Installation	24

Installation and Maintenance Requirements

Before Starting

Read and understand this chapter before beginning the installation of your system.

The use and application of the information contained herein require expertise in the design and programming of automated control systems. Only you, the user, machine builder or integrator, can be aware of all the conditions and factors present during installation and setup, operation, and maintenance of the machine or process, and can therefore determine the automation and associated equipment and the related safeties and interlocks which can be effectively and properly used. When selecting automation and control equipment, and any other related equipment or software, for a particular application, you must also consider any applicable local, regional or national standards and/or regulations.

Pay particular attention in conforming to any safety information, different electrical requirements, and normative standards that would apply to your machine or process in the use of this equipment.

Disconnecting Power

All options and modules should be assembled and installed before installing the control system on a mounting rail, onto a mounting plate or in a panel. Remove the control system from its mounting rail, mounting plate or panel before disassembling the equipment.

DANGER

HAZARD OF ELECTRIC SHOCK, EXPLOSION OR ARC FLASH

- Disconnect all power from all equipment including connected devices prior to removing any covers or doors, or installing or removing any accessories, hardware, cables, or wires except under the specific conditions specified in the appropriate hardware guide for this equipment.
- Always use a properly rated voltage sensing device to confirm the power is off where and when indicated.
- Replace and secure all covers, accessories, hardware, cables, and wires and confirm that a proper ground connection exists before applying power to the unit.
- Use only the specified voltage when operating this equipment and any associated products.

Failure to follow these instructions will result in death or serious injury.

Programming Considerations

WARNING

UNINTENDED EQUIPMENT OPERATION

- Only use software approved by Schneider Electric for use with this equipment.
- Update your application program every time you change the physical hardware configuration.

Failure to follow these instructions can result in death, serious injury, or equipment damage.

Operating Environment

In addition to the **Environmental Characteristics**, refer to **Product Related Information** in the beginning of the present document for important information regarding installation in hazardous locations for this specific equipment.

NOTE: For important safety information and the environment characteristics of the TMC4 cartridges, see the M241 Logic Controller Hardware Guide.

Installation Considerations

WARNING

UNINTENDED EQUIPMENT OPERATION

- Use appropriate safety interlocks where personnel and/or equipment hazards exist.
- Install and operate this equipment in an enclosure appropriately rated for its intended environment and secured by a keyed or tooled locking mechanism.
- Use the sensor and actuator power supplies only for supplying power to the sensors or actuators connected to the module.
- Power line and output circuits must be wired and fused in compliance with local and national regulatory requirements for the rated current and voltage of the particular equipment.
- Do not use this equipment in safety-critical machine functions unless the equipment is otherwise designated as functional safety equipment and conforming to applicable regulations and standards.
- Do not disassemble, repair, or modify this equipment.
- Do not connect any wiring to reserved, unused connections, or to connections designated as No Connection (N.C.).

Failure to follow these instructions can result in death, serious injury, or equipment damage.

NOTE: JDYX2 or JDYX8 fuse types are UL-recognized and CSA approved.

TMC4 Installation

Installation Considerations

The TMC4 cartridge is designed to operate within the same temperature range as the controllers, including the controller derating for extended temperature operation, and temperature restrictions associated with the mounting positions. Refer to the controller mounting position and clearance (see *Modicon M241 Logic Controller, Hardware Guide*) for more information.

Installation

DANGER

ELECTRIC SHOCK OR ARC FLASH

- Disconnect all power from all equipment including connected devices prior to removing any covers or doors, or installing or removing any accessories, hardware, cables, or wires.
- Always use a properly rated voltage sensing device to confirm the power is off where and when indicated.
- Use protective gloves when installing or removing the cartridges.
- Replace and secure all covers, accessories, hardware, cables, and wires and confirm that a proper ground connection exists before applying power to the unit.
- Use only the specified voltage when operating this equipment and any associated products.

Failure to follow these instructions will result in death or serious injury.

NOTICE

ELECTROSTATIC DISCHARGE

- Verify that empty cartridge slots have their covers in place before applying power to the controller.
- Do not touch the contacts of the cartridge.
- Only handle the cartridge on the housing.
- Take the necessary protective measures against electrostatic discharges.

Failure to follow these instructions can result in equipment damage.

The following table describes the different steps to install a TMC4 cartridge on the controller:

Step	Action
1	Disconnect all power from all equipment prior to removing any covers or installing a cartridge.
2	Remove the cartridge from the packaging.
3	Press the locking clips on the top and bottom of the cover with your fingers and pull up the cartridge slot cover gently. Remove by hand the cartridge slot cover from the controller. NOTE: Keep the cover to reuse it for the de-installation.

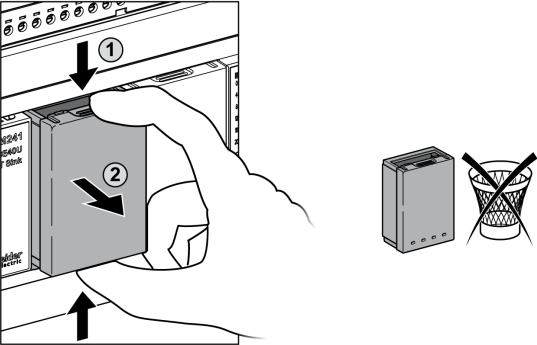

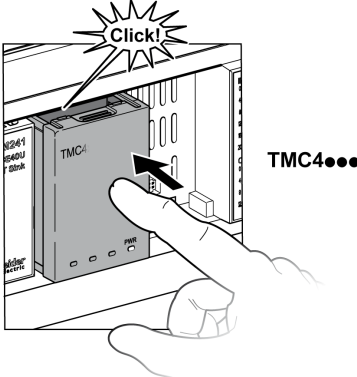
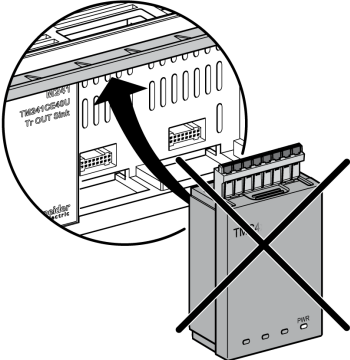
Step	Action
4	<p data-bbox="288 203 727 251">Place the cartridge in the slot on the controller. Push the cartridge into the slot until it clicks.</p>  <p data-bbox="288 698 1104 722">NOTE: Do not insert the cartridge with its removable spring terminal block connected.</p> 

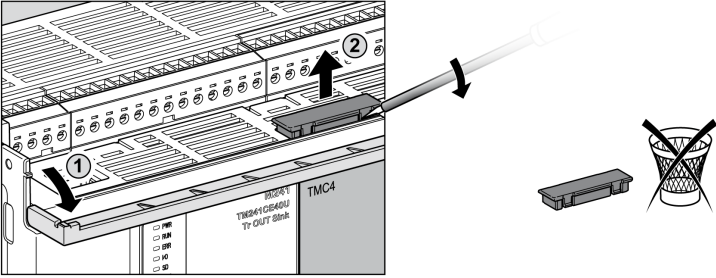
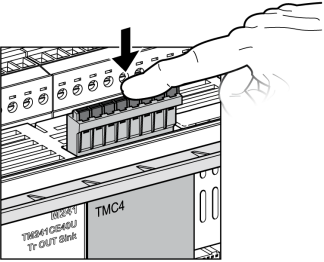
Step	Action
5	<p>Rotate the controller top connections cover to have more clearance to insert the cartridge removable spring terminal block.</p> <p>Press the locking clip on the side of the terminal block cover with an insulated screwdriver and pull up the cover gently. Remove the slot cover from the controller.</p> <p>NOTE: Keep the cover to reuse it for the de-installation.</p> 
6	<p>Insert the removable spring terminal block in the cartridge until it clicks.</p> 

De-installation

⚡ ⚠ DANGER

ELECTRIC SHOCK OR ARC FLASH

- Disconnect all power from all equipment including connected devices prior to removing any covers or doors, or installing or removing any accessories, hardware, cables, or wires.
- Always use a properly rated voltage sensing device to confirm the power is off where and when indicated.
- Use protective gloves when installing or removing the cartridges.
- Replace and secure all covers, accessories, hardware, cables, and wires and confirm that a proper ground connection exists before applying power to the unit.
- Use only the specified voltage when operating this equipment and any associated products.

Failure to follow these instructions will result in death or serious injury.

NOTICE

ELECTROSTATIC DISCHARGE

- Verify that empty cartridge slots have their covers in place before applying power to the controller.
- Do not touch the contacts of the cartridge.
- Only handle the cartridge on the housing.
- Take the necessary protective measures against electrostatic discharges.

Failure to follow these instructions can result in equipment damage.

The following table describes the different steps to de-install a TMC4 cartridge from the controller.

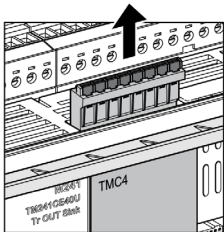
Step	Action
1	Disconnect all power from all equipment, including connected devices, prior to removing a cartridge.
2	<p>Pull out by hand the removable spring terminal block from the cartridge.</p> 

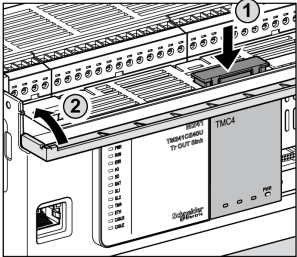
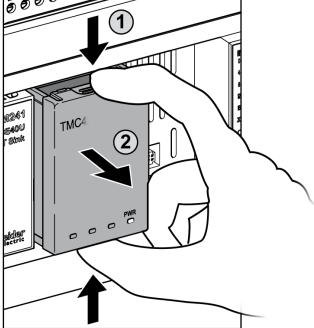
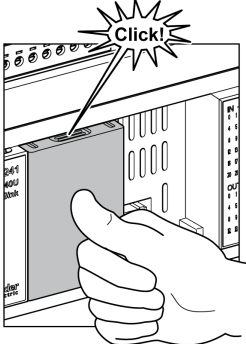
Step	Action
3	<p data-bbox="316 203 1001 251">Place the terminal block slot cover in the slot on the top of the controller. Push the slot cover into the slot until it clicks.</p> 
4	<p data-bbox="316 568 1204 641">Press the locking clips on the top and bottom of the cartridge with your fingers and pull up the cartridge gently. Remove by hand the cartridge from the controller.</p> 
5	<p data-bbox="316 1034 857 1083">Place the cartridge slot cover in the slot on the controller. Push the cartridge slot cover into the slot until it clicks.</p> 

Section 2.3

TMC4 Electrical Requirements

What Is in This Section?

This section contains the following topics:

Topic	Page
Wiring Best Practices	32
Grounding the M241 System	35

Wiring Best Practices

Overview

This section describes the wiring guidelines and associated best practices to be respected when using the M241 Logic Controller system.

DANGER

HAZARD OF ELECTRIC SHOCK, EXPLOSION OR ARC FLASH

- Disconnect all power from all equipment including connected devices prior to removing any covers or doors, or installing or removing any accessories, hardware, cables, or wires except under the specific conditions specified in the appropriate hardware guide for this equipment.
- Always use a properly rated voltage sensing device to confirm the power is off where and when indicated.
- Replace and secure all covers, accessories, hardware, cables, and wires and confirm that a proper ground connection exists before applying power to the unit.
- Use only the specified voltage when operating this equipment and any associated products.

Failure to follow these instructions will result in death or serious injury.

WARNING

LOSS OF CONTROL

- The designer of any control scheme must consider the potential failure modes of control paths and, for certain critical control functions, provide a means to achieve a safe state during and after a path failure. Examples of critical control functions are emergency stop and overtravel stop, power outage and restart.
- Separate or redundant control paths must be provided for critical control functions.
- System control paths may include communication links. Consideration must be given to the implications of unanticipated transmission delays or failures of the link.
- Observe all accident prevention regulations and local safety guidelines.¹
- Each implementation of this equipment must be individually and thoroughly tested for proper operation before being placed into service.

Failure to follow these instructions can result in death, serious injury, or equipment damage.

¹ For additional information, refer to NEMA ICS 1.1 (latest edition), "Safety Guidelines for the Application, Installation, and Maintenance of Solid State Control" and to NEMA ICS 7.1 (latest edition), "Safety Standards for Construction and Guide for Selection, Installation and Operation of Adjustable-Speed Drive Systems" or their equivalent governing your particular location.

Wiring Guidelines

The following rules must be applied when wiring a M241 Logic Controller system:

- I/O and communication wiring must be kept separate from the power wiring. Route these 2 types of wiring in separate cable ducting.
- Verify that the operating conditions and environment are within the specification values.
- Use proper wire sizes to meet voltage and current requirements.
- Use copper conductors (required).
- Use twisted pair, shielded cables for analog, and/or fast I/O.
- Use twisted pair, shielded cables for networks, and fieldbus.

Use shielded, properly grounded cables for all analog and high-speed inputs or outputs and communication connections. If you do not use shielded cable for these connections, electromagnetic interference can cause signal degradation. Degraded signals can cause the controller or attached modules and equipment to perform in an unintended manner.

WARNING

UNINTENDED EQUIPMENT OPERATION

- Use shielded cables for all fast I/O, analog I/O and communication signals.
- Ground cable shields for all analog I/O, fast I/O and communication signals at a single point¹.
- Route communication and I/O cables separately from power cables.

Failure to follow these instructions can result in death, serious injury, or equipment damage.

¹Multipoint grounding is permissible if connections are made to an equipotential ground plane dimensioned to help avoid cable shield damage in the event of power system short-circuit currents.

For more details, refer to Grounding Shielded Cables (*see page 35*).

NOTE: Surface temperatures may exceed 60 °C (140 °F). To conform to IEC 61010 standards, route primary wiring (wires connected to power mains) separately and apart from secondary wiring (extra low voltage wiring coming from intervening power sources). If that is not possible, double insulation is required such as conduit or cable gains.

Rules for Removable Spring Terminal Block

The following table shows the cable types and wire sizes for a **3.81 mm (0.15 in.)** pitch removable spring terminal block:

mm ²	0.2...1.5	0.2...1.5	0.25...1.5	0.25...0.75
AWG	24...16	24...16	23...16	23...19

The use of copper conductors is required.

DANGER

FIRE HAZARD

- Use only the correct wire sizes for the current capacity of the I/O channels and power supplies.
- For relay output (2 A) wiring, use conductors of at least 0.5 mm² (AWG 20) with a temperature rating of at least 80 °C (176 °F).
- For common conductors of relay output wiring (7 A), or relay output wiring greater than 2 A, use conductors of at least 1.0 mm² (AWG 16) with a temperature rating of at least 80 °C (176 °F).

Failure to follow these instructions will result in death or serious injury.

The spring clamp connectors of the terminal block are designed for only one wire or one cable end. Two wires to the same connector must be installed with a double wire cable end to help prevent loosening.

DANGER

LOOSE WIRING CAUSES ELECTRIC SHOCK

Do not insert more than one wire per connector of the spring terminal blocks unless using a double wire cable end (ferrule).

Failure to follow these instructions will result in death or serious injury.

Grounding the M241 System

Overview

To help minimize the effects of electromagnetic interference, cables carrying the fast I/O, analog I/O, and field bus communication signals must be shielded.

WARNING

UNINTENDED EQUIPMENT OPERATION

- Use shielded cables for all fast I/O, analog I/O, and communication signals.
- Ground cable shields for all fast I/O, analog I/O, and communication signals at a single point¹.
- Route communications and I/O cables separately from power cables.

Failure to follow these instructions can result in death, serious injury, or equipment damage.

¹Multipoint grounding is permissible if connections are made to an equipotential ground plane dimensioned to help avoid cable shield damage in the event of power system short-circuit currents.

The use of shielded cables requires compliance with the following wiring rules:

- For protective ground connections (PE), metal conduit or ducting can be used for part of the shielding length, provided there is no break in the continuity of the ground connections. For functional ground (FE), the shielding is intended to attenuate electromagnetic interference and the shielding must be continuous for the length of the cable. If the purpose is both functional and protective, as is often the case for communication cables, the cable must have continuous shielding.
- Wherever possible, keep cables carrying one type of signal separate from the cables carrying other types of signals or power.

Protective Ground (PE) on the Backplane

The protective ground (PE) should be connected to the conductive backplane by a heavy-duty wire, usually a braided copper cable with the maximum allowable cable section.

Shielded Cables Connections

Cables carrying the fast I/O, analog I/O, and field bus communication signals must be shielded. The shielding must be securely connected to ground. The fast I/O and analog I/O shields may be connected either to the functional ground (FE) or to the protective ground (PE) of your M241 Logic Controller. The field bus communication cable shields must be connected to the protective ground (PE) with a connecting clamp secured to the conductive backplane of your installation.

WARNING

ACCIDENTAL DISCONNECTION FROM PROTECTIVE GROUND (PE)

- Do not use the TM2XMTGB Grounding Plate to provide a protective ground (PE).
- Use the TM2XMTGB Grounding Plate only to provide a functional ground (FE).

Failure to follow these instructions can result in death, serious injury, or equipment damage.

The shielding of the Modbus cable must be connected to the protective ground (PE).

DANGER

HAZARD OF ELECTRIC SHOCK

- The grounding terminal connection (PE) must be used to provide a protective ground at all times.
- Make sure that an appropriate, braided ground cable is attached to the PE/PG ground terminal before connecting or disconnecting the network cable to the equipment.

Failure to follow these instructions will result in death or serious injury.

Protective Ground (PE) Cable Shielding

To ground the shield of a cable through a grounding clamp:

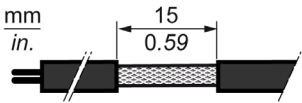
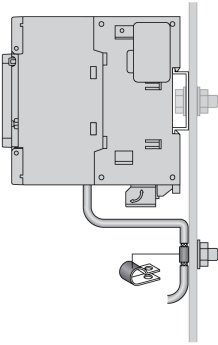
Step	Description	
1	Strip the shielding for a length of 15 mm (0.59 in.)	
2	Attach the cable to the conductive backplane plate by attaching the grounding clamp to the stripped part of the shielding as close as possible to the M241 Logic Controller system base.	

NOTE: The shielding must be clamped securely to the conductive backplane to ensure a good contact.

Functional Ground (FE) Cable Shielding

To connect the shield of a cable through the Grounding Bar:

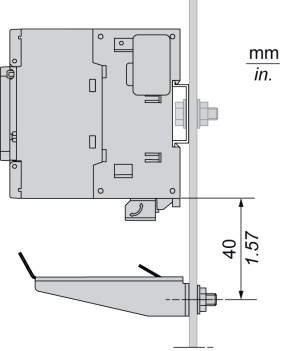
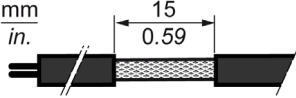
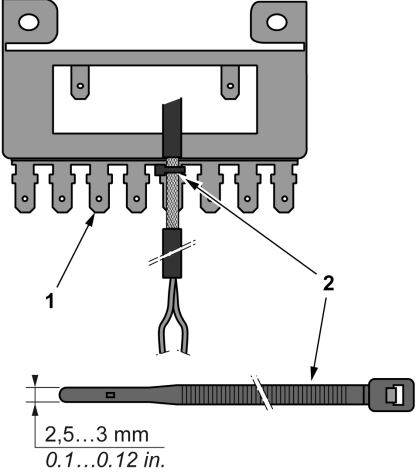
Step	Description	
1	Install the Grounding Bar directly on the conductive backplane below the M241 Logic Controller system as illustrated.	
2	Strip the shielding for a length of 15 mm (0.59 in.).	
3	Tightly clamp on the blade connector (1) using nylon fastener (2) (width 2.5...3 mm (0.1...0.12 in.)) and appropriate tool.	

NOTE: Use the TM2XMTGB Grounding Bar for Functional Ground (FE) connections.

Part II

TMC4 Standard Cartridges

What Is in This Part?

This part contains the following chapters:

Chapter	Chapter Name	Page
3	TMC4AI2 Analog Voltage/Current Inputs	41
4	TMC4TI2 Analog Temperature Inputs	47
5	TMC4AQ2 Analog Voltage/Current Outputs	55

Chapter 3

TMC4AI2 Analog Voltage/Current Inputs

Overview

This chapter describes the TMC4AI2 cartridge, its characteristics, and its connections.

What Is in This Chapter?

This chapter contains the following topics:

Topic	Page
TMC4AI2 Presentation	42
TMC4AI2 Characteristics	44
TMC4AI2 Wiring Diagram	46

TMC4AI2 Presentation

Overview

The following features are integrated into the TMC4AI2 cartridge:

- 2 analog inputs (voltage or current)
- removable spring terminal block, 3.81 mm (0.15 in.) pitch

Main Characteristics

Characteristic		Value	
	Signal type	Voltage	Current
Number of input channels		2	
Input range		0...10 Vdc	0...20 mA 4...20 mA
Resolution		12 bits (4096 steps)	
Connection type		3.81 mm (0.15 in.) pitch, removable spring terminal block	
Weight		55 g (1.94 oz)	

Power LED

The following diagram shows a TMC4A12 cartridge with its power LED labeled **PWR**:

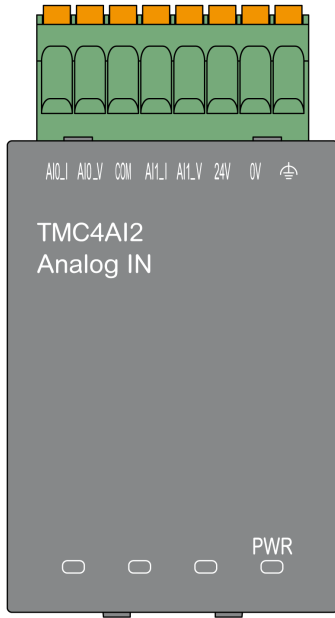

LED	Color	Status	Description
PWR	Green	On	The cartridge is powered by the logic controller and the external power supply (24 Vdc) is applied.
		Flashing	The cartridge is powered by the logic controller but the external power supply (24 Vdc) is not applied.
		Off	The cartridge is not powered by the logic controller.

TMC4AI2 Characteristics

Introduction

This section provides a general description of the TMC4AI2 cartridge characteristics.

⚠ WARNING

UNINTENDED EQUIPMENT OPERATION

Do not exceed any of the rated values specified in the environmental and electrical characteristics tables.

Failure to follow these instructions can result in death, serious injury, or equipment damage.

NOTE: For important safety information and the environment characteristics of the TMC4 cartridges, see the M241 Logic Controller Hardware Guide.

Connectors

The following diagram shows a TMC4AI2 cartridge marking and connectors:

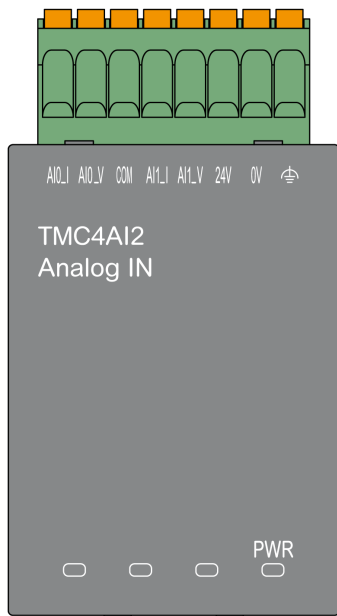

Input Characteristics

The following table describes the cartridge input characteristics:

Characteristics		Value	
		Voltage	Current
Rated input range		0...10 Vdc	0...20 mA 4...20 mA
Input impedance		> 1 M Ω	< 250 Ω
Sample duration time		1 ms per enabled channel	
Input type		single-ended	
Operating mode		self-scan	
Conversion mode		SAR type	
Maximum accuracy at ambient temperature: 25 °C (77 °F)		± 0.2 % of full scale	
Maximum accuracy on full operating temperature range		± 0.5 % of full scale	
Temperature drift		± 0.006 % of full scale per 1 °C (1.8 °F)	
Repeatability after stabilization time		± 0.2 % of full scale	
Non-linearity		± 0.05 % of full scale	
Digital resolution		12 bits (4096 steps)	
Input value of LSB		2.44 mV	4.88 μ V
Data type in application program		scalable from -32768 to 32767	
Input data out of detection range		yes	
Noise resistance	maximum temporary deviation during perturbations	± 2.0 % of full scale	
	cable type and maximum length	shielded	
		< 30 m (98.4 ft)	
	crosstalk (minimum)	80 dB	
common-mode rejection ratio (minimum)	65 dB		
Isolation	isolation between inputs and internal logic	500 Vdc	
	isolation between inputs	not isolated	
Maximum continuous overload allowed (without damage)		30 Vdc	40 mA dc
Input filter		software filter: 6 levels	
External power supply	supply voltage	24 Vdc ± 15 %	
	power consumption	2 W	

TMC4AI2 Wiring Diagram

Introduction

This cartridge has a removable spring terminal block for the connection of the inputs.

Wiring

See Wiring Best Practices (*see page 32*).

Wiring Diagram

The following figure shows an example of the voltage and current input connection:

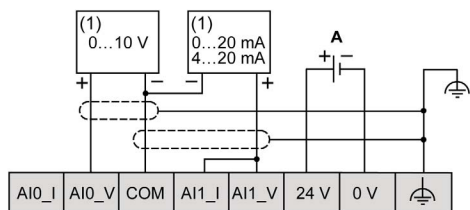

(1): Current/Voltage analog output device

A: External power supply

NOTE: Each input can be connected to either a voltage or current input.

Chapter 4

TMC4TI2 Analog Temperature Inputs

Overview

This chapter describes the TMC4TI2 cartridge, its characteristics, and its connections.

What Is in This Chapter?

This chapter contains the following topics:

Topic	Page
TMC4TI2 Presentation	48
TMC4TI2 Characteristics	50
TMC4TI2 Wiring Diagram	53

TMC4TI2 Presentation

Overview

The following features are integrated into the TMC4TI2 cartridge:

- 2 analog temperature inputs (thermocouple or RTD)
- removable spring terminal block, 3.81 mm (0.15 in.) pitch

Main Characteristics

Characteristic	Value		
	Signal type	Thermocouple	RTD
Number of input channels	2		
Input range	type: K, J, R, S, B, E, T, N		type: Pt100, Pt1000, Ni100, Ni1000
Resolution	14 bits (16384 steps)		
Connection type	3.81 mm (0.15 in.) pitch, removable spring terminal block		
Weight	55 g (1.94 oz)		

Power LED

The following diagram shows a TMC4T12 cartridge with its power LED labeled **PWR**:

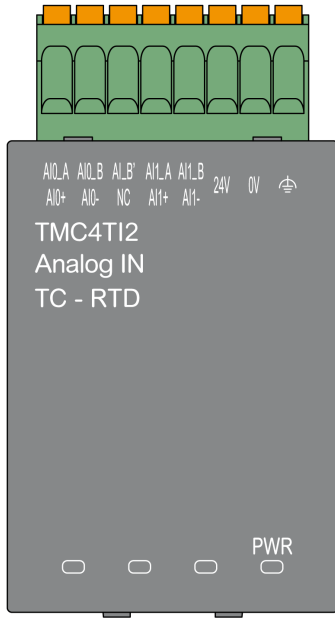

LED	Color	Status	Description
PWR	Green	On	The cartridge is powered by the logic controller and the external power supply (24 Vdc) is applied.
		Flashing	The cartridge is powered by the logic controller but the external power supply (24 Vdc) is not applied.
		Off	The cartridge is not powered by the logic controller.

TMC4TI2 Characteristics

Introduction

This section provides a general description of the TMC4TI2 cartridge characteristics.

⚠ WARNING

UNINTENDED EQUIPMENT OPERATION

Do not exceed any of the rated values specified in the environmental and electrical characteristics tables.

Failure to follow these instructions can result in death, serious injury, or equipment damage.

NOTE: For important safety information and the environment characteristics of the TMC4 cartridges, see the M241 Logic Controller Hardware Guide.

Connectors

The following diagram shows a TMC4TI2 cartridge marking and connectors:

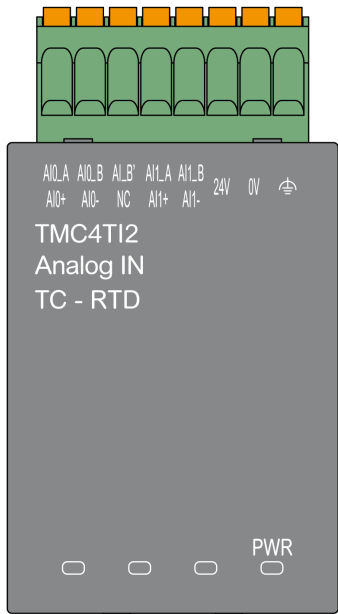

Input Characteristics

The following table describes the cartridge input characteristics:

Characteristics		Value	
	Signal Type	Thermocouple	RTD (2, 3, or 4 wires)
Rated input range		thermocouple type: K: –200...+1300 °C (–328...+2372 °F) J: –200...+1000 °C (–328...+1832 °F) R: 0...+1760 °C (+32...+3200 °F) S: 0...+1760 °C (+32...+3200 °F) B: +250...+1820 °C (+482...+3308 °F) E: –200...+800 °C (–328...+1472 °F) T: –200...+400 °C (–328...+752 °F) N: –200...+1300 °C (–328...+2372 °F)	RTD type: Pt100: –200...+850 °C (–328...+1562 °F) Pt1000: –200...+850 °C (–328...+1562 °F) Ni100: –60...+180 °C (–76...+356 °F) Ni1000: –60...+180 °C (–76...+356 °F)
Cold junction compensation		internal compensation	–
Input impedance		> 1 MΩ	
Sample duration time		100 ms per enabled channel + 1 scan time	
Input type		single-ended	
Operating mode		self-scan	
Conversion mode		SAR type	
Maximum accuracy at ambient temperature: 25 °C (77 °F)		K, J, R, S, E, T, N: ± 0.2 % of full scale + junction compensation accuracy (± 4 °C (± 7.2 °F)) B: ± 0.2 % of full scale for measured temperature range: 250...400 °C (482...752 °F) ± 0.1 % of full scale for measured temperature range: 400...1280 °C (752...2336 °F)	± 0.5 °C (± 0.9 °F)
Temperature drift		± 0.008 % of full scale per 1 °C (1.8 °F)	
Repeatability after stabilization time		± 0.1 % of full scale	
Non-linearity		± 0.05 % of full scale	
Digital resolution		14 bits (16384 steps)	

Characteristics		Value	
	Signal Type	Thermocouple	RTD (2, 3, or 4 wires)
Input value of LSB		0.1 °C (0.18 °F)	
Data type in application program		scalable from -32768 to 32767	
Input data out of detection range		yes	
Noise resistance	maximum temporary deviation during perturbations	± 2 % of full scale	
	total cable type, length, and resistance	twisted-pair shielded	
		< 100 m (328.1 ft)	
		< 100 Ω	< 30 Ω
	external crosstalk (minimum)	80 dB	
50/60 Hz common-mode rejection ratio (minimum)	90 dB		
50/60 Hz differential-mode rejection ratio (minimum)	60 dB		
Isolation	isolation between inputs and internal logic	500 Vdc	
	isolation between inputs	not isolated	
Maximum continuous overload allowed (without damage)		6 Vdc	
Behavior when the temperature sensor is disconnected or broken		detected	
External power supply	supply voltage	24 Vdc ± 15 %	
	power consumption	2 W	

TMC4TI2 Wiring Diagram

Introduction

This cartridge has a removable spring terminal block for the connection of the inputs.

Wiring

See Wiring Best Practices (*see page 32*).

Wiring Diagram

The following figure shows an example of 3-wire RTD and thermocouple probe connections:

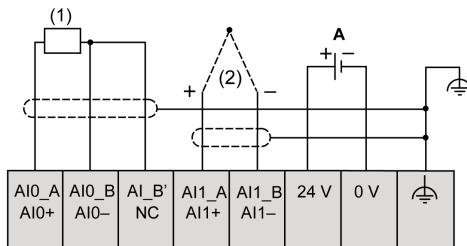

(1): RTD

(2): Thermocouple

A: External power supply

The following figure shows an example of a pair of 3-wire RTD connections:

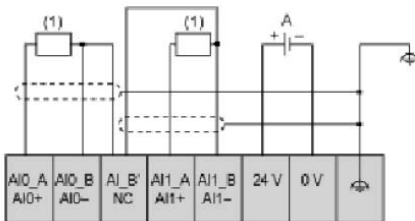

(1): RTD

A: External power supply

The following figure shows an example of a pair of thermocouple connections:

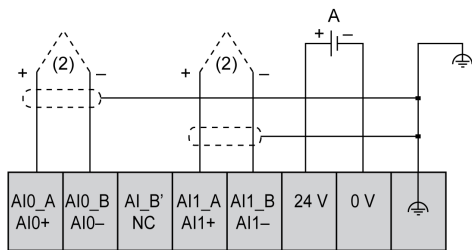

(2): Thermocouple

A: External power supply

The following figure shows an example of 4-wire RTD and thermocouple connections:

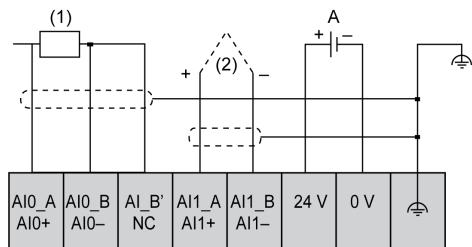

(1): RTD

(2): Thermocouple

A: External power supply

NOTE: Each input can be connected to either an RTD or thermocouple probe.

⚠ WARNING

UNINTENDED EQUIPMENT OPERATION

Do not connect wires to unused terminals and/or terminals indicated as “No Connection (N.C.)”.

Failure to follow these instructions can result in death, serious injury, or equipment damage.

Chapter 5

TMC4AQ2 Analog Voltage/Current Outputs

Overview

This chapter describes the TMC4AQ2 cartridge, its characteristics, and its connections.

What Is in This Chapter?

This chapter contains the following topics:

Topic	Page
TMC4AQ2 Presentation	56
TMC4AQ2 Characteristics	58
TMC4AQ2 Wiring Diagram	60

TMC4AQ2 Presentation

Overview

The following features are integrated into the TMC4AQ2 cartridge:

- 2 analog outputs (voltage or current)
- removable spring terminal block, 3.81 mm (0.15 in.) pitch

Main Characteristics

Characteristic	Value	
	Signal type	Current
Number of output channels	2	
Output range	0...10 Vdc	4...20 mA (dc)
Resolution	16 bits (65536 steps)	
Connection type	3.81 mm (0.15 in.) pitch, removable spring terminal block	
Weight	55 g (1.94 oz)	

Power LED

The following diagram shows a TMC4AQ2 cartridge with its power LED labeled **PWR**:

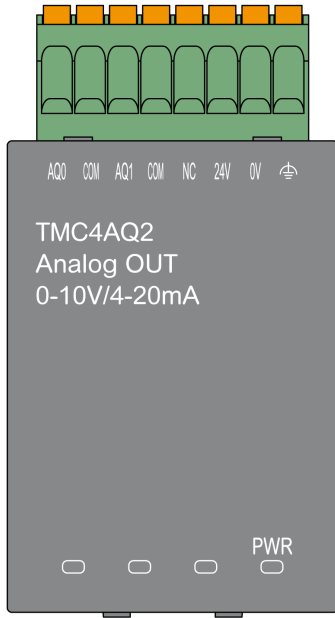

LED	Color	Status	Description
PWR	Green	On	The cartridge is powered by the logic controller and the external power supply (24 Vdc) is applied.
		Flashing	The cartridge is powered by the logic controller but the external power supply (24 Vdc) is not applied.
		Off	The cartridge is not power by the logic controller.

TMC4AQ2 Characteristics

Introduction

This section provides a general description of the TMC4AQ2 cartridge characteristics.

⚠ WARNING

UNINTENDED EQUIPMENT OPERATION

Do not exceed any of the rated values specified in the environmental and electrical characteristics tables.

Failure to follow these instructions can result in death, serious injury, or equipment damage.

NOTE: For important safety information and the environment characteristics of the TMC4 cartridges, see the M241 Logic Controller Hardware Guide.

Connectors

The following diagram shows a TMC4AQ2 cartridge marking and connectors:

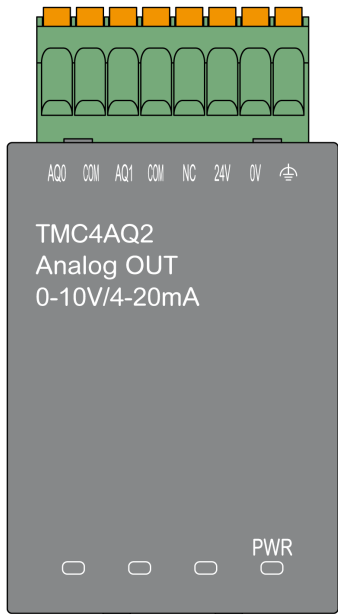

Output Characteristics

The following table describes the cartridge output characteristics:

Characteristics		Value	
	Signal Type	Voltage	Current
Rated output range		0...10 Vdc	4...20 mA (dc)
Load impedance		> 2 K Ω	< 500 Ω
Application load type		resistive load	
Settling time		10 ms	
Total output system transfer time		10 ms + 1 scan time	
Maximum accuracy at ambient temperature without EMC disturbance: 25 °C (77 °F)		± 0.2 % of full scale	
Temperature drift		± 0.006 % of full scale per 1 °C (1.8 °F)	
Repeatability after stabilization time		± 0.5 % of full scale	
Non-linearity		± 0.05 % of full scale	
Output ripple		± 20 mV	
Output voltage drop		1 %	
Overshoot		0 %	
Maximum output deviation		± 0.5 % of full scale	
Digital resolution		16 bits (65536 steps)	
Output value of LSB		0.153 mV	0.305 μ A
Data type in application program		0...4095	
Noise resistance	maximum temporary deviation during perturbations	± 2 % of full scale	
	cable type and maximum length	shielded	
		< 30 m (98.4 ft)	
	external crosstalk (minimum)	80 dB	
50/60 Hz common-mode rejection ratio (minimum)	90 dB		
Isolation	isolation between outputs and internal logic	500 Vdc	
	isolation between outputs	not isolated	
Output protection		short circuit protection	open circuit protection
Behavior when internal power supply level is lower than threshold		outputs are set to 0	
Behavior when external power is not applied		PWR LED flashing	
External power supply	supply voltage	24 Vdc ± 15 %	
	power consumption	2 W	

TMC4AQ2 Wiring Diagram

Introduction

This cartridge has a removable spring terminal block for the connection of the outputs.

Wiring

See Wiring Best Practices (*see page 32*).

Wiring Diagram

The following figure shows an example of the voltage and current outputs connection:

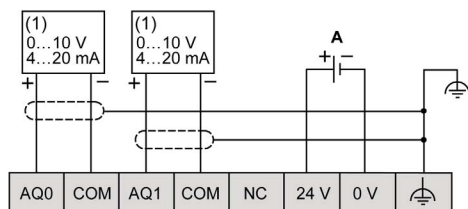

(1): Current/Voltage analog input device

A: External power supply

NOTE: Each output can be connected either as a voltage or current output.

⚠ WARNING

UNINTENDED EQUIPMENT OPERATION

Do not connect wires to unused terminals and/or terminals indicated as “No Connection (N.C.)”.

Failure to follow these instructions can result in death, serious injury, or equipment damage.

Part III

TMC4 Application Cartridges

What Is in This Part?

This part contains the following chapters:

Chapter	Chapter Name	Page
6	TMC4HOIS01 Hoisting	63
7	TMC4PACK01 Packaging	69

Chapter 6

TMC4HOIS01 Hoisting

Overview

This chapter describes the TMC4HOIS01 cartridge, its characteristics, and its connections.

What Is in This Chapter?

This chapter contains the following topics:

Topic	Page
TMC4HOIS01 Presentation	64
TMC4HOIS01 Characteristics	66
TMC4HOIS01 Wiring Diagram	68

TMC4HOIS01 Presentation

Overview

The following features are integrated into the TMC4HOIS01 cartridge:

- 2 analog inputs (voltage or current) for hoisting load cell
- removable spring terminal block, 3.81 mm (0.15 in.) pitch

Main Characteristics

Characteristic		Value	
	Signal type	Voltage	Current
Number of input channels		2	
Input range		0...10 Vdc	0...20 mA 4...20 mA
Resolution		12 bits (4096 steps)	
Connection type		3.81 mm (0.15 in.) pitch, removable spring terminal block	
Weight		55 g (1.94 oz)	

Power LED

The following diagram shows a TMC4HOIS01 cartridge with its power LED labeled **PWR**:

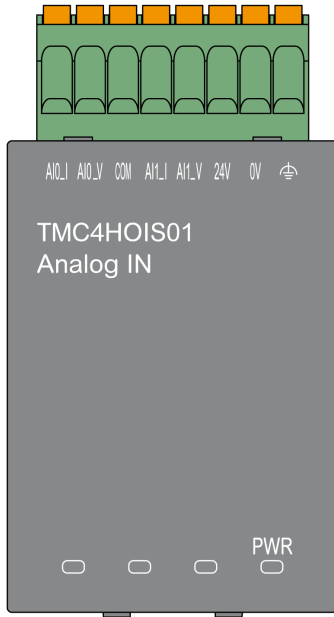

LED	Color	Status	Description
PWR	Green	On	The cartridge is powered by the logic controller and the external power supply (24 Vdc) is applied.
		Flashing	The cartridge is powered by the logic controller but the external power supply (24 Vdc) is not applied.
		Off	The cartridge is not powered by the logic controller.

TMC4HOIS01 Characteristics

Introduction

This section provides a general description of the TMC4HOIS01 cartridge characteristics.

⚠ WARNING

UNINTENDED EQUIPMENT OPERATION

Do not exceed any of the rated values specified in the environmental and electrical characteristics tables.

Failure to follow these instructions can result in death, serious injury, or equipment damage.

NOTE: For important safety information and the environment characteristics of the TMC4 cartridges, see the M241 Logic Controller Hardware Guide.

Connectors

The following diagram shows a TMC4HOIS01 cartridge marking and connectors:

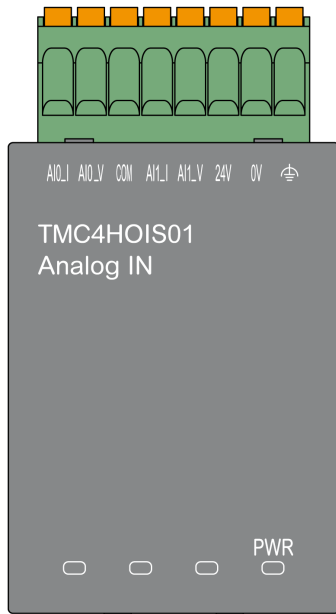

Input Characteristics

The following table describes the cartridge input characteristics:

Characteristics		Value	
		Signal Type	Voltage
Rated input range		0...10 Vdc	0...20 mA 4...20 mA
Input impedance		> 1 MΩ	< 250 Ω
Sample duration time		1 ms per enabled channel	
Input type		single-ended	
Operating mode		self-scan	
Conversion mode		SAR type	
Maximum accuracy at ambient temperature: 25 °C (77 °F)		± 0.2 % of full scale	
Maximum accuracy on full operating temperature range		± 0.5 % of full scale	
Temperature drift		± 0.006 % of full scale per 1 °C (1.8 °F)	
Repeatability after stabilization time		± 0.2 % of full scale	
Non-linearity		± 0.05 % of full scale	
Digital resolution		12 bits (4096 steps)	
Input value of LSB		2.44 mV	4.88 μV
Data type in application program		scalable from -32768 to 32767	
Input data out of detection range		yes	
Noise resistance	maximum temporary deviation during perturbations	± 2.0 % of full scale	
	cable type and maximum length	shielded < 30 m (98.4 ft)	
	crosstalk (minimum)	80 dB	
	common-mode rejection ratio (minimum)	65 dB	
Isolation	isolation between inputs and internal logic	500 Vdc	
	isolation between inputs	not isolated	
Maximum continuous overload allowed (without damage)		30 Vdc	40 mA dc
Input filter		software filter: 6 levels	
External power supply	supply voltage	24 Vdc ± 15 %	
	power consumption	2 W	

TMC4HOIS01 Wiring Diagram

Introduction

This cartridge has a removable spring terminal block for the connection of the inputs.

Wiring

See Wiring Best Practices (*see page 32*).

Wiring Diagram

The following figure shows an example of the voltage and current input connection:

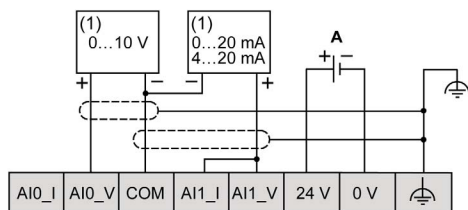

(1): Current/Voltage analog output device

A: External power supply

NOTE: Each input can be connected to either a voltage or current input.

Chapter 7

TMC4PACK01 Packaging

Overview

This chapter describes the TMC4PACK01 cartridge, its characteristics, and its connections.

What Is in This Chapter?

This chapter contains the following topics:

Topic	Page
TMC4PACK01 Presentation	70
TMC4PACK01 Characteristics	72
TMC4PACK01 Wiring Diagram	74

TMC4PACK01 Presentation

Overview

The following features are integrated into the TMC4PACK01 cartridge:

- 2 analog inputs (voltage or current) for packaging
- removable spring terminal block, 3.81 mm (0.15 in.) pitch

Main Characteristics

Characteristic		Value	
	Signal type	Voltage	Current
Number of input channels		2	
Input range		0...10 Vdc	0...20 mA 4...20 mA
Resolution		12 bits (4096 steps)	
Connection type		3.81 mm (0.15 in.) pitch, removable spring terminal block	
Weight		55 g (1.94 oz)	

Power LED

The following diagram shows a TMC4PACK01 cartridge with its power LED labeled **PWR**:

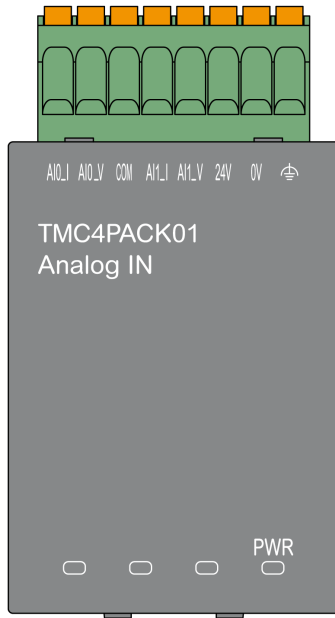

LED	Color	Status	Description
PWR	Green	On	The cartridge is powered by the logic controller and the external power supply (24 Vdc) is applied.
		Flashing	The cartridge is powered by the logic controller but the external power supply (24 Vdc) is not applied.
		Off	The cartridge is not powered by the logic controller.

TMC4PACK01 Characteristics

Introduction

This section provides a general description of the TMC4PACK01 cartridge characteristics.

⚠ WARNING

UNINTENDED EQUIPMENT OPERATION

Do not exceed any of the rated values specified in the environmental and electrical characteristics tables.

Failure to follow these instructions can result in death, serious injury, or equipment damage.

NOTE: For important safety information and the environment characteristics of the TMC4 cartridges, see the M241 Logic Controller Hardware Guide.

Connectors

The following diagram shows a TMC4PACK01 cartridge marking and connectors:

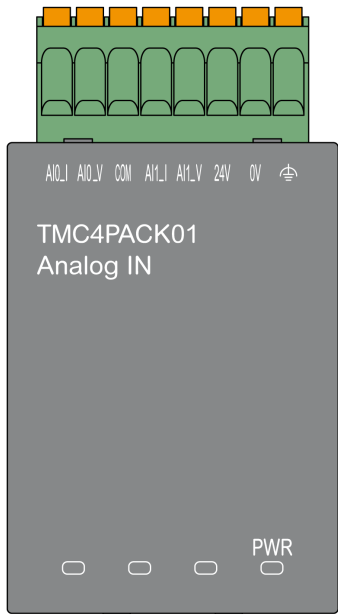

Input Characteristics

The following table describes the cartridge input characteristics:

Characteristics		Value	
	Signal Type	Voltage	Current
Rated input range		0...10 Vdc	0...20 mA 4...20 mA
Input impedance		> 1 M Ω	< 250 Ω
Sample duration time		1 ms per enabled channel	
Input type		single-ended	
Operating mode		self-scan	
Conversion mode		SAR type	
Maximum accuracy at ambient temperature: 25 °C (77 °F)		± 0.2 % of full scale	
Maximum accuracy on full operating temperature range		± 0.5 % of full scale	
Temperature drift		± 0.006 % of full scale per 1 °C (1.8 °F)	
Repeatability after stabilization time		± 0.2 % of full scale	
Non-linearity		± 0.05 % of full scale	
Digital resolution		12 bits (4096 steps)	
Input value of LSB		2.44 mV	4.88 μ V
Data type in application program		scalable from -32768 to 32767	
Input data out of detection range		yes	
Noise resistance	maximum temporary deviation during perturbations	± 2.0 % of full scale	
	cable type and maximum length	shielded < 30 m (98.4 ft)	
	crosstalk (minimum)	80 dB	
	common-mode rejection ratio (minimum)	65 dB	
Isolation	isolation between inputs and internal logic	500 Vdc	
	isolation between inputs	not isolated	
Maximum continuous overload allowed (without damage)		30 Vdc	40 mA dc
Input filter		software filter: 6 levels	
External power supply	supply voltage	24 Vdc ± 15 %	
	power consumption	2 W	

TMC4PACK01 Wiring Diagram

Introduction

This cartridge has a removable spring terminal block for the connection of the inputs.

Wiring

See Wiring Best Practices (*see page 32*).

Wiring Diagram

The following figure shows an example of the voltage and current input connection:

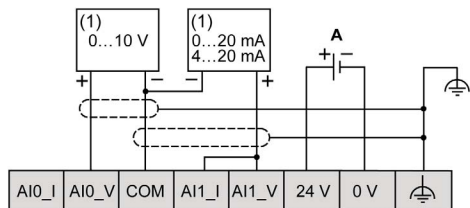

(1): Current/Voltage analog output device

A: External power supply

NOTE: Each input can be connected to either a voltage or current input.

Glossary



M

Modbus

The protocol that allows communications between many devices connected to the same network.

P

PE

(Protective Earth) A common grounding connection to help avoid the hazard of electric shock by keeping any exposed conductive surface of a device at earth potential. To avoid possible voltage drop, no current is allowed to flow in this conductor (also referred to as *protective ground* in North America or as an equipment grounding conductor in the US national electrical code).



C

cartridge

compatibility, *16*

description, *15*

features, *15*

TMC4, *39, 61*

TMC4AI2, *41*

TMC4AQ2, *55*

TMC4HOIS01, *63*

TMC4PACK01, *69*

TMC4TI2, *47*

certifications and standards, *20*

compatibility

cartridge, *16*

D

description

cartridge, *15*

E

environment, *19*

F

features

cartridge, *15*

G

Grounding, *35*

I

intended use, *6*

Q

qualification of personnel, *6*

T

TMC4

cartridge, *39, 61*

TMC4AI2

cartridge, *41*

TMC4AQ2

cartridge, *55*

TMC4HOIS01

cartridge, *63*

TMC4PACK01

cartridge, *69*

TMC4TI2

cartridge, *47*

W

wiring, *32*

