



# CMB18-08BPPEC0SA00

CMB

CAPACITIVE PROXIMITY SENSORS

**SICK**  
Sensor Intelligence.



Illustration may differ



### Ordering information

Type	Part no.
CMB18-08BPPECOSA00	6080638

Other models and accessories → [www.sick.com/CMB](http://www.sick.com/CMB)

### Detailed technical data

#### Features

<b>Housing</b>	Cylindrical thread design
<b>Thread size</b>	M18 x 1
<b>Diameter</b>	Ø 18 mm
<b>Sensing range <math>S_n</math></b>	0 mm ... 8 mm
<b>Safe sensing range <math>S_a</math></b>	6.12 mm <sup>1)</sup>
<b>Installation type</b>	Flush
<b>Switching frequency</b>	50 Hz
<b>Connection type</b>	Male connector M12, 4-pin
<b>Switching output</b>	PNP
<b>Output function</b>	Complementary
<b>Output characteristic</b>	Wire configurable
<b>Electrical wiring</b>	DC 4-wire
<b>Adjustment</b>	Potentiometer, 11 turns (Sensitivity) Teach-in by wire (Sensitivity) IO-Link (Sensor parameters and Smart Task functions)
<b>Enclosure rating</b>	IP67 IP68 <sup>2)</sup> IP69K
<b>Special features</b>	Visual adjustment indicator, Smart Task, IO-Link
<b>Pin 2 configuration</b>	External input, Teach-in, switching signal
<b>Items supplied</b>	Mounting nut, PA12 plastic (2x)

<sup>1)</sup> For flush mounting in electrically conductive materials  $S_a = 0.8 \times S_r$  at temperatures  $<0 \text{ }^\circ\text{C}$  and  $>60 \text{ }^\circ\text{C}$ .

<sup>2)</sup> 1 m water depth / 60 min.

Screwdriver for potentiometer adjustment (1 x)

<sup>1)</sup> For flush mounting in electrically conductive materials  $S_a = 0.8 \times S_r$  at temperatures  $<0 \text{ }^\circ\text{C}$  and  $>60 \text{ }^\circ\text{C}$ .

<sup>2)</sup> 1 m water depth / 60 min.

## Mechanics/electronics

<b>Supply voltage</b>	10 V DC ... 36 V DC
<b>Ripple</b>	$\leq 10 \%$ <sup>1)</sup>
<b>Voltage drop</b>	$\leq 2.5 \text{ V DC}$ <sup>2)</sup>
<b>Current consumption</b>	$\leq 20 \text{ mA}$ <sup>3)</sup>
<b>Time delay before availability</b>	$\leq 300 \text{ ms}$
<b>Hysteresis</b>	3 % ... 20 %
<b>Reproducibility</b>	$\leq 5 \%$ <sup>4) 5)</sup>
<b>Temperature drift (of <math>S_r</math>)</b>	$\pm 10 \%$
<b>EMC</b>	EN 61000-4-2 ESD: $> 40 \text{ kV CD}$ and AD EN 61000-4-3 Radiated RF: $20 \text{ V/m}$ EN 61000-4-4 burst: $\pm 4 \text{ kV} / 5 \text{ kHz}$ EN 61000-4-5 Surge: Voltage supply $> 2 \text{ kV}$ with $500 \text{ ohm}$ ; switching output $> 2 \text{ kV}$ with $500 \text{ ohm}$ EN 61000-4-6 HF: $> 20 \text{ V}_{\text{rms}}$ EN 61000-4-8 mains frequency magnetic fields: Permanent $> 60 \text{ A/m}$ , $75.9 \mu \text{ tesla}$ ; briefly $> 600 \text{ A/m}$ , $759 \mu \text{ tesla}$
<b>Continuous current <math>I_a</math></b>	$\leq 200 \text{ mA}$
<b>Short-circuit protection</b>	✓
<b>Reverse polarity protection</b>	✓
<b>Power-up pulse protection</b>	✓
<b>Shock and vibration resistance</b>	EN 60068-2-27 shock resistance $E_a$ : $30 \text{ g } 11 \text{ ms}$ ; 3 shocks in each direction of the 3 coordinate axes IEC 60068-2-31 drop test: 2 times from 1 m, 100 times from 0.5 m EN 60068-2-6 vibration resistance $F_c$ : $10 \text{ Hz} \dots 150 \text{ Hz}$ , $1 \text{ mm} / 15 \text{ g}$
<b>Ambient operating temperature</b>	$-30 \text{ }^\circ\text{C} \dots +85 \text{ }^\circ\text{C}$ <sup>6)</sup>
<b>Ambient temperature, storage</b>	$-40 \text{ }^\circ\text{C} \dots +85 \text{ }^\circ\text{C}$
<b>Housing material</b>	Plastic, PBT
<b>Housing length</b>	85 mm
<b>Thread length</b>	55 mm
<b>Tightening torque, max.</b>	$\leq 2.6 \text{ Nm}$
<b>UL File No.</b>	NRKH.E191603

<sup>1)</sup> Of  $U_b$ .

<sup>2)</sup> At  $I_a$  max.

<sup>3)</sup> Without load.

<sup>4)</sup> Of  $S_r$ .

<sup>5)</sup> Supply voltage  $U_b$  and constant ambient temperature  $T_a$ .

<sup>6)</sup>  $+120 \text{ }^\circ\text{C}$  short time, at the front of the sensor.

## Safety-related parameters

<b>MTTF<sub>D</sub></b>	916 years
<b>DC<sub>avg</sub></b>	0%
<b>T<sub>M</sub> (mission time)</b>	20 years

### Communication interface

<b>Communication interface</b>	IO-Link V1.1
<b>Communication Interface detail</b>	COM2 (38,4 kBaud)
<b>Cycle time</b>	> 5 ms
<b>Process data length</b>	4 Byte
<b>Process data structure</b>	Bit 0 = switching signal Q <sub>L1</sub> Bit 1 = switching signal Q <sub>L2</sub> Bit 2 = Sensor switching channel Q <sub>int1</sub> Bit 3 = Sensor switching channel Q <sub>int2</sub> Bit 4 = Contamination alarm for switching channel Q <sub>int1</sub> Bit 5 = Contamination channel for Q <sub>int2</sub> Bit 6 = Temperature alarm Bit 7 = Short-circuit Bit 16 ... 31 = Analog value (digit value, not linearized)

### Reduction factors

<b>Note</b>	The values are reference values which may vary
<b>Metal</b>	1
<b>Water</b>	1
<b>PVC</b>	Approx. 0.4
<b>Oil</b>	Approx. 0.25
<b>Glass</b>	0.6
<b>Ceramics</b>	0.5
<b>Alcohol</b>	0.7
<b>Wood</b>	0.2 ... 0.7

### Installation note

<b>Remark</b>	Associated graphic see "Installation"
<b>B</b>	18 mm
<b>C</b>	18 mm
<b>D</b>	24 mm
<b>F</b>	24 mm

### Smart Task

<b>Smart Task name</b>	Base logics
<b>Logic function</b>	Direct AND OR Window Hysteresis
<b>Timer function</b>	Deactivated On delay Off delay ON and OFF delay Impulse (one shot)
<b>Inverter</b>	Yes
<b>Switching signal</b>	
Switching signal Q <sub>L1</sub>	Switching output
Switching signal Q <sub>L2</sub>	Switching output

## Classifications

<b>eCl@ss 5.0</b>	27270102
<b>eCl@ss 5.1.4</b>	27270102
<b>eCl@ss 6.0</b>	27270102
<b>eCl@ss 6.2</b>	27270102
<b>eCl@ss 7.0</b>	27270102
<b>eCl@ss 8.0</b>	27270102
<b>eCl@ss 8.1</b>	27270102
<b>eCl@ss 9.0</b>	27270102
<b>eCl@ss 10.0</b>	27270102
<b>eCl@ss 11.0</b>	27270102
<b>eCl@ss 12.0</b>	27274201
<b>ETIM 5.0</b>	EC002715
<b>ETIM 6.0</b>	EC002715
<b>ETIM 7.0</b>	EC002715
<b>ETIM 8.0</b>	EC002715
<b>UNSPSC 16.0901</b>	39122230

## Installation note

Flush installation

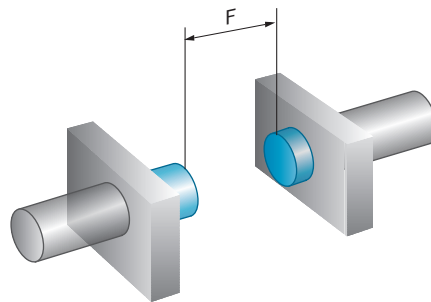
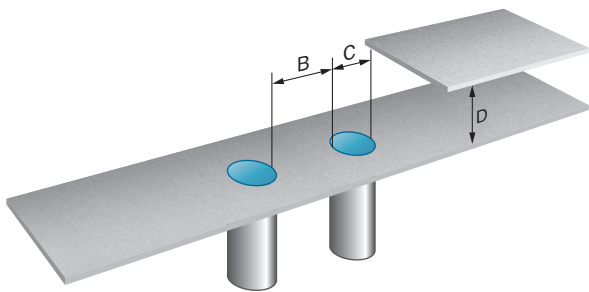

## Connection diagram

Cd-526

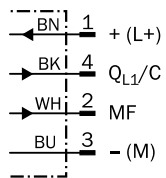

Q<sub>L1</sub>/C = Switching output,  
IO-Link communication  
MF = Multifunction

### Response diagram

CMB18, Flush installation

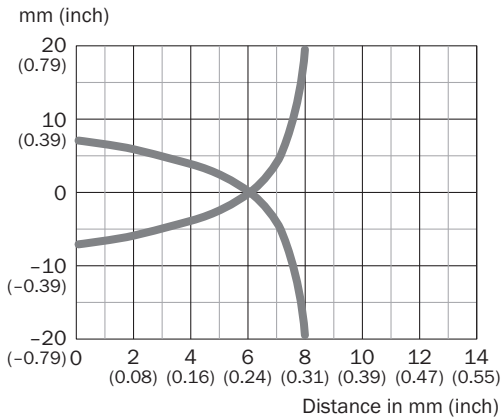

### Dimensional drawing (Dimensions in mm (inch))

CMB18, flush, connector

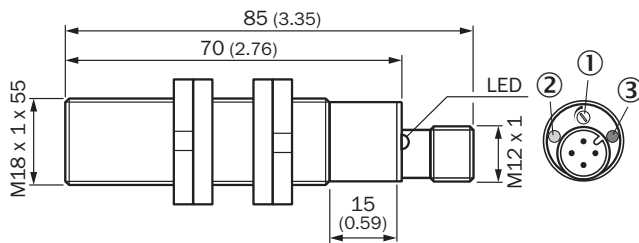



- ① Potentiometer for sensitivity adjustment
- ② LED yellow: output active
- ③ LED green: operating indicator

### Recommended accessories

Other models and accessories → [www.sick.com/CMB](http://www.sick.com/CMB)

	Brief description	Type	Part no.
<b>Connection modules</b>			
	IO-Link V1.1 Class A port, USB2.0 port, optional external power supply 24V / 1A	IOLA2US-01101 (SiLink2 Master)	1061790
<b>Mounting brackets and plates</b>			
	Mounting plate for M18 sensors, steel, zinc coated, without mounting hardware	BEF-WG-M18	5321870
	Mounting bracket for M18 sensors, steel, zinc coated, without mounting hardware	BEF-WN-M18	5308446

	Brief description	Type	Part no.
Plug connectors and cables			
	Head A: female connector, M12, 4-pin, straight, A-coded Head B: Flying leads Cable: Sensor/actuator cable, PVC, unshielded, 5 m	YF2A14-050VB3XLEAX	2096235
	Head A: male connector, M12, 4-pin, straight Cable: unshielded	STE-1204-G	6009932
Sensor Integration Gateway			
	<ul style="list-style-type: none"> <li>• <b>Further functions:</b> Web server integrated, USB connection for easy configuration of the SIG200 Sensor Integration Gateway with SOPAS ET, the engineering tool from SICK, logic editor is available for easy configuration of logic functions</li> <li>• <b>Connection CONFIG:</b> 1 x M8, 4-pin female connector, USB 2.0 (USB-A)</li> <li>• <b>Logic editor:</b> yes</li> <li>• <b>Communication interface:</b> IO-Link, USB, Ethernet, PROFINET, REST API</li> <li>• <b>Product category:</b> IO-Link Master</li> </ul>	SIG200-0A0412200	1089794

## SICK AT A GLANCE

SICK is one of the leading manufacturers of intelligent sensors and sensor solutions for industrial applications. A unique range of products and services creates the perfect basis for controlling processes securely and efficiently, protecting individuals from accidents and preventing damage to the environment.

We have extensive experience in a wide range of industries and understand their processes and requirements. With intelligent sensors, we can deliver exactly what our customers need. In application centers in Europe, Asia and North America, system solutions are tested and optimized in accordance with customer specifications. All this makes us a reliable supplier and development partner.

Comprehensive services complete our offering: SICK LifeTime Services provide support throughout the machine life cycle and ensure safety and productivity.

For us, that is “Sensor Intelligence.”

## WORLDWIDE PRESENCE:

Contacts and other locations –[www.sick.com](http://www.sick.com)