

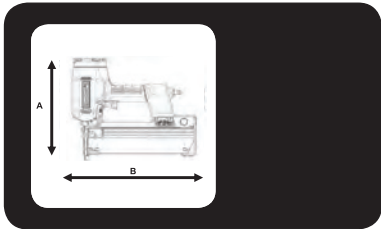

haubold®

PN775XII





PN775XII

		L = 371 mm H = 297 mm W = 101 mm

1,6 l (6 bar) /
Ps max. = 8 bar

	LWA.1s = 109 dBA LpA.1s = 104 dBA LpA.1s1M = 96 dBA
	Vibration = 3,1 m/s⁻²

156 x =		
		L = 30 - 75 mm

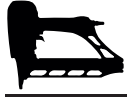

	<p>Sequential trigger actuation/ Einzelauslösung/ enkelschots/ Déclenchement du tir - mode séquentiel/ Funcionamiento secuencial "en continuo"/ Gatilho de actuação sequencial/ funzionamento sequenziale (colpo a colpo)/ Enkeltskuds aftrækker/ Enkelskott/ Enkeltskudds avtrekker/ Kertalaukaisu/ Üksiklasu meetodil töötamine/ Uruchromienie spustu sekwencyjne/ Sekvenčni spoušť/ Egyes lövés (szakaszosan működtetett elsütő billentyűvel)/ Posamezno proženje/ Kontaktirajte singl / Последовательная активация при нажатии на курок/ Sekvenčná aktivácia spúšte/ التشغيل بالزر التسلسلي المقيد / Nuoseklusis paleidimo mechanizmas/ Sekvenciālās palaišanas iedarbināšana Raðkveikjuvirkjun</p>
---	---

	<p>Contact trigger actuation/ Kontaktauslösung/ repeterend schieten/ Déclenchement du tir - mode rafale/ Funcionamiento por contacto "clavo a clavo"/ Gatilho de actuação por contacto/ funzionamento a contatto/ Støtdskydnings aftrækker/ Støtskjutning/ Støtspikrings avtrekker/ Kosketuslaukaisu/ Automaatmeetodil töötamine/ Uruchromienie spustu przez kontakt/ Kontaktní spoušť/ Sorozatlövés (folyamatosan behúzott elsütő billentyűvel)/ Kontaktno proženje/ Kontaktirajte pokretanje/ Контактная активация при нажатии на курок/ Kontaktná aktivácia spúšte/ التشغيل بتلامس الزر / Kontaktinis paleidimo mechanizmas/ Kontakta palaišanas iedarbināšana/ Snertikveikjuvirkjun</p>
---	---

<p>Model: PN775XII Contact Euro Code: 503748</p>		
		

		
<p>No. 014748 + No. 577026</p>	<p>No. 014121</p>	

Accessories



<p>No. 151299 / No. 576216</p>
<p>0,5 l oil / 1 l oil</p>

NOTES

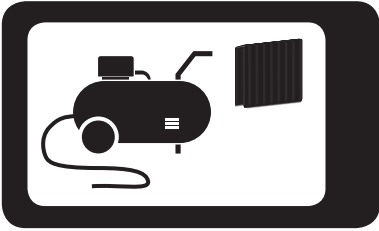

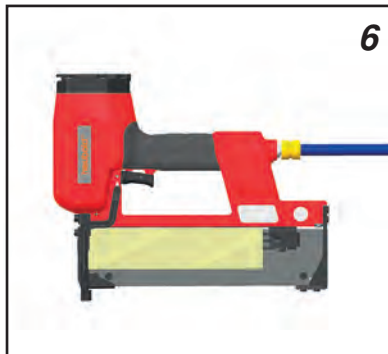
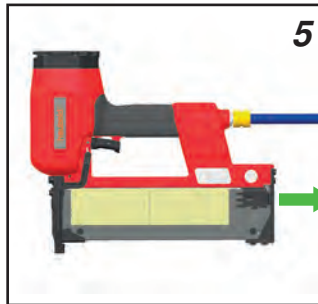
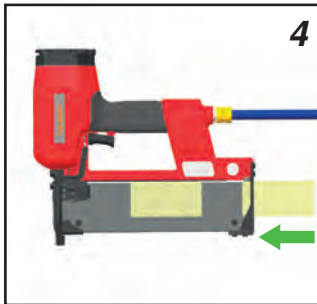
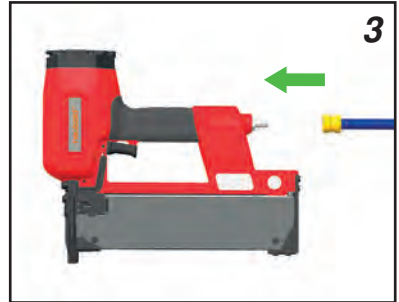
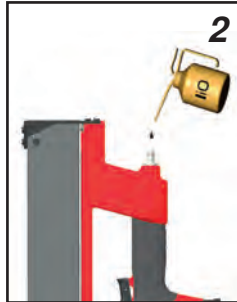
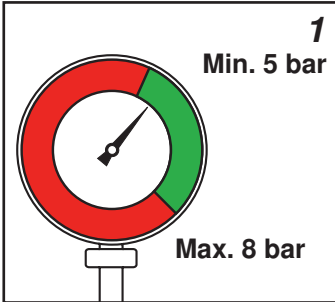

014 748





014 748

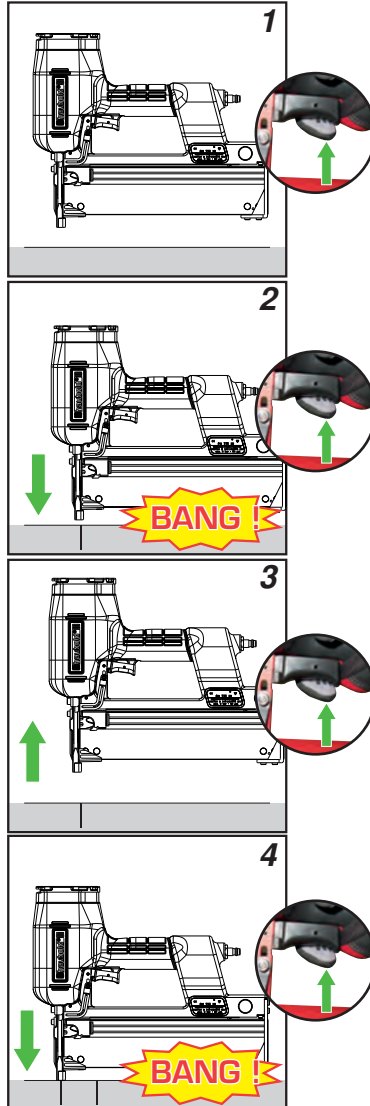

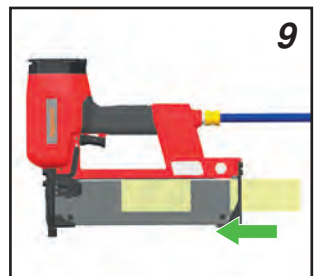
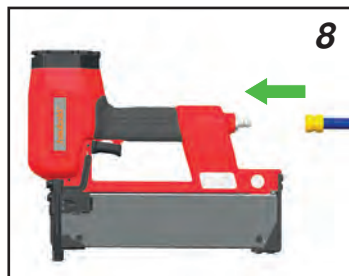
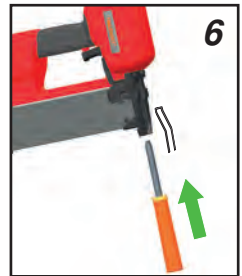
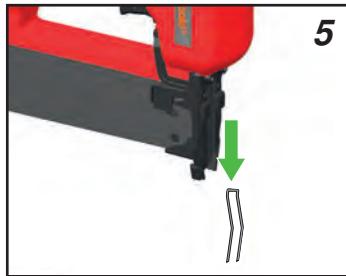
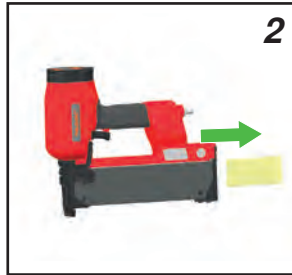
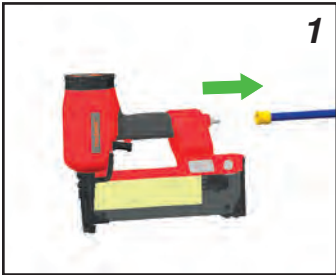
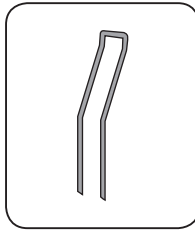

YY/WW....

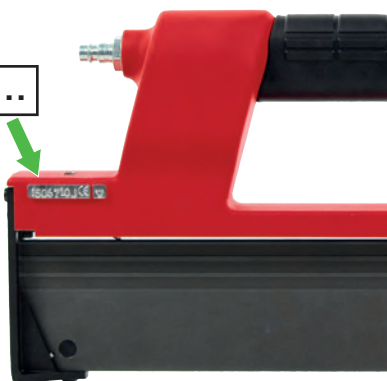

YY= Year of manufacture
WW = Week of manufacture

**Resting position/ Ruheposition/ Position de repos/ Ruststand/
Posición de descanso/ Posizione di riposo/ Posição de des-
canso/ Pozycja spoczynku/ Klidová poloha/ Nyugalmi állapot/
Положение в нерабочем состоянии/ Θέση αδράνειας/ Hvile-
tilling/ Viloläge/ Hvileposisjon/ Lepoasento/ Položaj mirovanja/
Pokožová poloha/ Položaj mirovanja/ وضع السكون / Ramybės
padėtis/ Ooteasend/ Miera stāvoklis/ Hvíldarstaða**



haubold[®]

ITW CONSTRUCTION PRODUCTS EUROPE
Code 577026 (05/2019)
www.spitpaslode.com