

THIS COPY IS PROVIDED ON A RESTRICTED BASIS AND IS NOT TO BE USED IN ANY WAY DETRIMENTAL TO THE INTERESTS OF PANDUIT CORP.

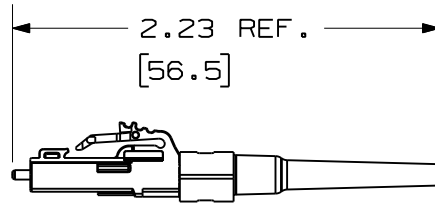

PANDUIT PART NUMBER	FIBER TYPE
FLCSMC5* ¹ ** ²	50/125um MULTIMODE
FLCSMC6* ¹ ** ²	62.5/125um MULTIMODE
FLCSMCX* ¹ ** ²	50/125um OM3 MULTIMODE
FLCSSC* ¹ ** ²	9/125um SINGLEMODE

*¹ ALPHA KEY DESIGNATOR (SEE TABLE 2, SHEET 2)
 **² KEY COLOR DESIGNATOR (SEE TABLE 2, SHEET 2)

NOTES:

- SEE CATALOG FOR ADDITIONAL PART NUMBER SUFFIXES TO INDICATE COLOR AND/OR PACKAGE QUANTITY.
- ACCEPTS 50/125um, 62.5/125um, 50/125 OM3 MULTIMODE OR 9/125um SINGLEMODE 900um BUFFERED GLASS OPTICAL FIBER.
- FULLY COMPLIES WITH THE FIBER OPTIC CONNECTOR PERFORMANCE REQUIREMENTS AS SPECIFIED BY TIA/EIA-568-B.3.
- MATERIAL:
 BODY/HARDWARE: PLASTIC
 BOOT: THERMOPLASTIC RUBBER
 FERRULE: ZIRCONIA CERAMIC
- ALL MATERIALS AND COMPONENTS USED MEET THE MATERIAL RESTRICTIONS OF RoHS, (EUROPEAN DIRECTIVE 2002/95/EC ON THE RESTRICTION OF HAZARDOUS SUBSTANCES) AS PROPOSED BY THE RoHS TECHNICAL ADAPTATION COMMITTEE.
- DIMENSIONS IN BRACKETS ARE METRIC [mm].

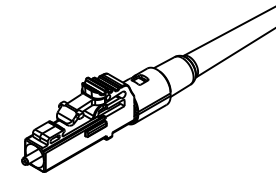
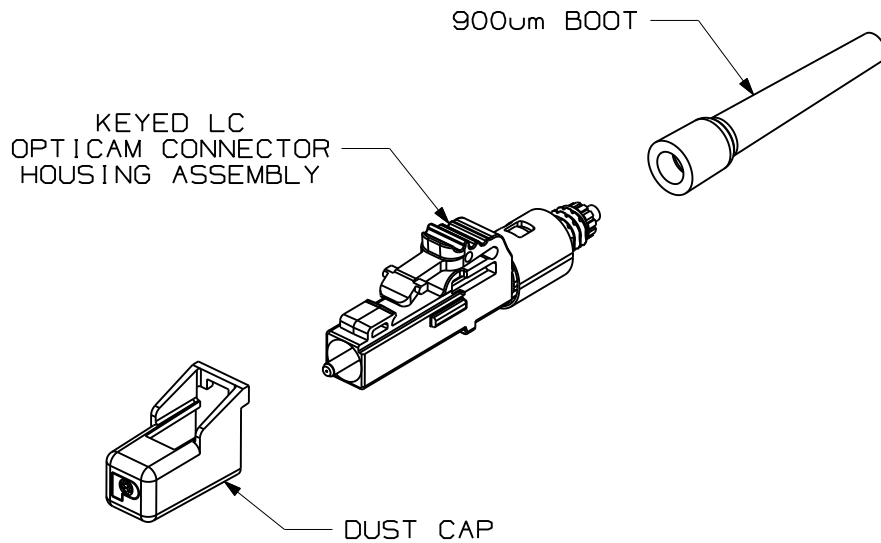

KEYED OPTICAM SIMPLEX LC CONNECTOR
 CUSTOMER DRAWING



PANDUIT™
 CORP.
 TINLEY PARK, ILL 60477

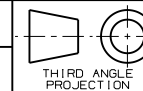

ALL DIMENSIONS ARE GIVEN IN INCHES UNLESS OTHERWISE SPECIFIED.
 DIMENSIONAL TOLERANCES ARE:
 (.X) ±.03 | (.XXX) ±.010 | (.3) ±.015
 (.XX) ±.03 | (.8) ANGLES

DRAWING FILENAME
 M02759AB_DC_SIM_00B.prt

SCALE
 NONE

DRAWN BY
 MC

REVIEW DRAWING NUMBERS

PART NO.
 SEE SHEET 2

DATE
 12-04-07

DRAWING NO.
 02759-09

CHK'D
 PJI

(SHT. 1 of 2)
 SIZE
 A

REV	DATE	BY	CHK	DESCRIPTION	ECN	R	CUST	SUP	OTH
1	03-19-08	MC		RELEASED TO PRODUCTION	02759-09				

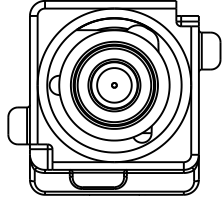
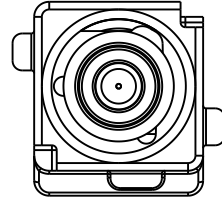
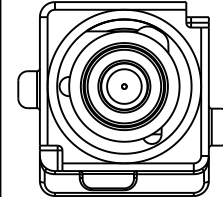
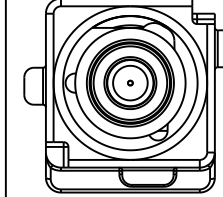
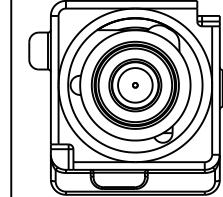
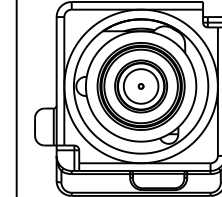
TABLE 2 - KEYED LC CONNECTOR PART NUMBER AND HOUSING KEY CONFIGURATIONS					
KEY: -A-	KEY: -B-	KEY: -C-	KEY: -D-	KEY: -E-	KEY: -F-
MULTIMODE CONNECTOR P/N: FLCSMC*ABL	MULTIMODE CONNECTOR P/N: FLCSMC*BRD	MULTIMODE CONNECTOR P/N: FLCSMC*CGR	MULTIMODE CONNECTOR P/N: FLCSMC*DYL	MULTIMODE CONNECTOR P/N: FLCSMC*EOR	MULTIMODE CONNECTOR P/N: FLCSMC*FDB
SINGLEMODE CONNECTOR P/N: FLCSSCABL	SINGLEMODE CONNECTOR P/N: FLCSSCBRD	SINGLEMODE CONNECTOR P/N: FLCSSCCGR	SINGLEMODE CONNECTOR P/N: FLCSSCDYL	SINGLEMODE CONNECTOR P/N: FLCSSCEOR	SINGLEMODE CONNECTOR P/N: FLCSSCFDB
COLOR: BLACK	COLOR: RED	COLOR: GREEN	COLOR: YELLOW	COLOR: ORANGE	COLOR: DARK BLUE
					

* - DESIGNATES MULTIMODE FIBER TYPE (SEE TABLE 1, SHEET 1)

										KEYED OPTICAM SIMPLEX LC CONNECTOR CUSTOMER DRAWING		
										 PANDUIT ™ CORP. TINLEY PARK, ILL 60477		
										ALL DIMENSIONS ARE GIVEN IN INCHES UNLESS OTHERWISE SPECIFIED. DIMENSIONAL TOLERANCES ARE: (.X) ±.03 (.XXX) ±.010 (.3) ±.010 ANGLES		
										DRAWING FILENAME MO2759AB_DC_SIM_00B.prt		
										SCALE NONE		
										PART NO. SEE TABLE 2		
R	03-19-08	MC		RELEASED TO PRODUCTION	02759-09						DRAWING NO. 02759-09 (SHT. 2 of 2)	SIZE A
REV	DATE	BY	CHK	DESCRIPTION	ECN	R	CUST	SUP	OTH	CHK'D	PJI	