

HERO B

108734.02

novalux
ITALIAN LIGHTING DESIGN SINCE 1948

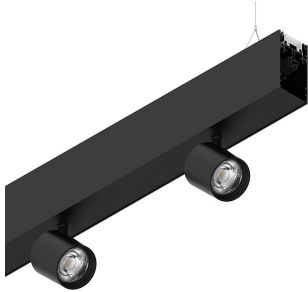

Features

Use: Indoor
Type of installation: SUSPENDED
Emission: DIRECT/INDIRECT
Optics: SPOT
Beam: 14°
Colour: BLACK
Dimming: ON/OFF
Emergency: NO
L: 1120mm
A: 53mm
H: 92mm
Made in: ITALY
Warranty: 5 years
Weight: 2.5kg

Tech data

Luminaire input power: 48.5W
Luminaire luminous flux: 4104lm
Direct luminous flux: 2028lm
Indirect luminous flux: 2076lm
IP: 40
Insulation class: I
Supply voltage: 220-240V 50/60Hz
SELV: Si

Source

Light source: LED
Source power: 2x13+18W
Colour temperature: 2700K
CRI: >90
Colour tolerance: 3 Step MacAdam
LED lifespan: 50000h L80 B20

Compliance

CEI EN 60598-1:2015 + A11:2009. IEC 60598-2:2015 2-1

Standards

Photobiological risk: RISK GROUP 1 Certified fixture in RISK GROUP 1 (Low Risk)-The fixture does not pose a hazard due to normal behavioral limitations on exposure - in accordance with CEI EN 62471:2010-01, IEC TR 62778:2014.

CAM edilizia: The product complies with the requirements for public buildings, ministerial decree of 23rd June 2022 n.256.

[View more product info](#)

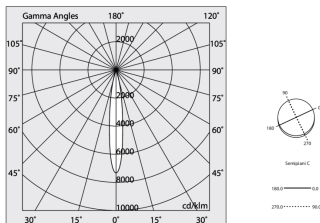
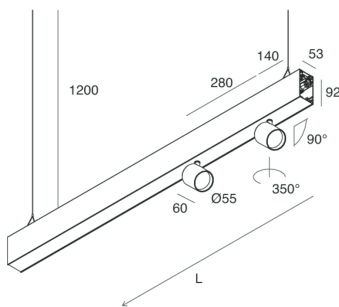

Novalux S.r.l. via Marzabotto, 2 40050 Funo di Argelato (BO) Italy
Tel: +39 051 860558 · Fax +39 051 6647859 · Mail: info@novalux.it · VAT number 00536541204 · novalux.com
Company subject to the management and coordination by SLV GmbH

This technical data sheet is owned by Novalux S.r.l., all rights reserved. Novalux S.r.l. reserves the right to make changes without prior notice.

HERO B

108734.02

novalux
ITALIAN LIGHTING DESIGN SINCE 1948

COMPLETION ACCESSORIES

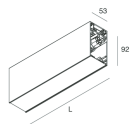

HERO B: MOD.CIECO 250 NE

1087A3.02

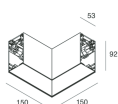

HERO B: MOD.CIECO ANG.SX 150 NE

1087A4.02

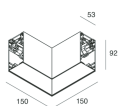

HERO B: MOD.CIECO ANG.DX 150 NE

1087A5.02

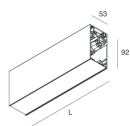

HERO B: MOD.CIECO 1120 NE

1087A6.02

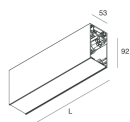

HERO B: MOD.CIECO 1400 NE

1087A7.02

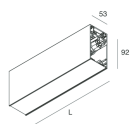

HERO B: MOD.CIECO 1680 NE

1087A8.02



Novalux S.r.l. via Marzabotto, 2 40050 Funo di Argelato (BO) Italy
Tel: +39 051 860558 · Fax +39 051 6647859 · Mail: info@novalux.it · VAT number 00536541204 · novalux.com
Company subject to the management and coordination by SLV GmbH

This technical data sheet is owned by Novalux S.r.l., all rights reserved. Novalux S.r.l. reserves the right to make changes without prior notice.

HERO B

108734.02

novalux
ITALIAN LIGHTING DESIGN SINCE 1948

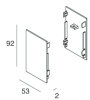

HERO B: COPPIA TESTATE NE

1087B1.02

MOUNTING ACCESSORIES

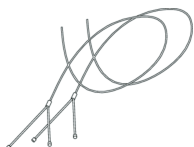

HERO B: KIT COPPIA CAVI SOSP. 5 M

1087B2.99

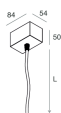

KIT ALIMENTAZIONE L1200 3P BIA

108919.01



KIT ALIMENTAZIONE L1200 3P NE

108919.02

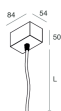

KIT ALIMENTAZIONE L3000 3P BIA

108920.01



KIT ALIMENTAZIONE L3000 3P NE

108920.02



Novalux S.r.l. via Marzabotto, 2 40050 Funo di Argelato (BO) Italy
Tel: +39 051 860558 · Fax +39 051 6647859 · Mail: info@novalux.it · VAT number 00536541204 · novalux.com
Company subject to the management and coordination by SLV GmbH

This technical data sheet is owned by Novalux S.r.l., all rights reserved. Novalux S.r.l. reserves the right to make changes without prior notice.