



CFP0600-XPXNNAX

CFP Cubic

CAPACITIVE LEVEL SENSOR

SICK
Sensor Intelligence.



Ordering information

Type	Part no.
CFP0600-XPXNNAX	1083109

Other models and accessories → www.sick.com/CFP_Cubic

Illustration may differ



Detailed technical data

Features

Medium	Fluids
Measurement	Switch, Continuous
Probe length	600 mm
Process temperature	-20 °C ... +80 °C
UL approval	✓
RoHS certificate	✓
IO-Link	✓

Performance

Accuracy of sensor element	± 15 mm, with water or oil under reference conditions
Reproducibility	< 5 mm
Resolution	< 2 mm
Response time	< 300 ms
Dielectricity constant	≥ 2
Conductivity	No limitation
Deactivated area at end of probe	7 mm ... 15 mm, Depending on probe length
MTTF	171 years
Display	✓

Electronics

Supply voltage	10 V DC ... 30 V DC ¹⁾
Power consumption	≤ 100 mA at 24 V DC without output load

¹⁾ All connections are polarity protected. All outputs are overload and short-circuit protected.

Initialization time	≤ 4 s
Protection class	III
Connection type	Round connector M12 x 1, 5-pin
Output signal	2 x PNP/NPN/push-pull transistor outputs switchable
Output load	4 mA ... 20 mA < 500 Ohm at $U_v > 15 V$, 4 mA ... 20 mA < 350 Ohm at $U_v > 12 V$, 0 V ... 10 V > 750 Ohm at $U_v 14 \geq V$
Hysteresis	Min. 3 mm, min. 2 °C, free adjustable
Output current	< 100 mA
Inductive load	< 1 H
Capacitive load	100 nF
Enclosure rating	IP67
Temperature drift	< 0.1 mm/K
Lower signal level	3.8 mA ... 4 mA
Upper signal level	20 mA ... 20.5 mA
Resolution of analog output	12 bit

¹⁾ All connections are polarity protected. All outputs are overload and short-circuit protected.

Mechanics

Wetted parts	Outer tube: polypropylene (PP-H) G 3/4" and 3/4" NPT: PPSU Easy-clamp bracket: PP
Process connection	Without process connection
Housing material	PBT / PC
Max. probe load	≤ 4 Nm
Probe diameter	16 mm

Ambient data

Ambient operating temperature	-20 °C ... +60 °C
Ambient temperature, storage	-40 °C ... +80 °C

Classifications

ECLASS 5.0	27200503
ECLASS 5.1.4	27200503
ECLASS 6.0	27200503
ECLASS 6.2	27200503
ECLASS 7.0	27200503
ECLASS 8.0	27200503
ECLASS 8.1	27200503
ECLASS 9.0	27200503
ECLASS 10.0	27200503
ECLASS 11.0	27200503
ECLASS 12.0	27200503
ETIM 5.0	EC001447
ETIM 6.0	EC001447
ETIM 7.0	EC001447

ETIM 8.0	EC001447
UNSPSC 16.0901	41113710

Type code

Probe length in mm

0100	100 mm (in increments of 50 mm)
0500	500 mm (in increments of 100 mm)
1000	1,000 mm

Special design

P Rod probe from PP

Process connection

- X** Without process connection
- A** G 3/4 A; made from PBT
- B** 3/4" NPT; made from PBT

Application type

N Oil and water application

Housing

N Plastic housing with display

Electrical output

- A** 2 digital outputs
- B** 2 digital outputs + 1 analog output
- C** 4 digital outputs + 2 analog outputs

Additional option

- T** With temperature sensor
- X** No additional options

CFP - X P N N

Not all variants of the type code can be combined!

Dimensional drawing (Dimensions in mm (inch))

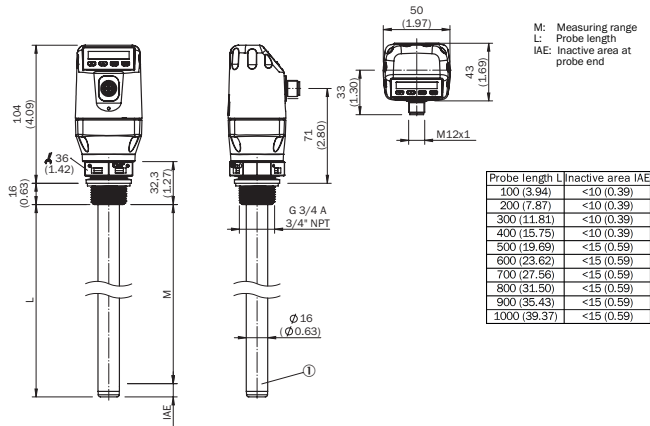



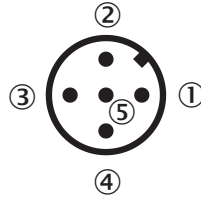
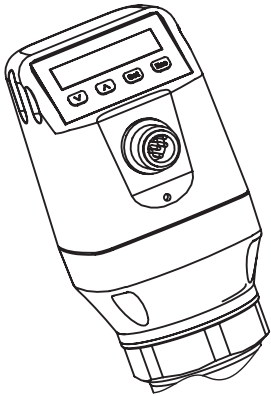

Connection type



- ① L⁺: Supply voltage
- ② Q_A: Analog current-/voltage output
- ③ M: Ground, reference ground for current-/voltage output
- ④ C/Q1: Switching output 2, PNP/NPN/DRV (Push-Pull) / IO-Link
- ⑤ Q₂: Switching output 2, PNP/NPN/DRV (Push-Pull)

Recommended accessories

Other models and accessories → www.sick.com/CFP_Cubic

	Brief description	Type	Part no.
Connection modules			
	IO-Link V1.1 Class A port, USB2.0 port, optional external power supply 24V / 1A	IOLA2US-01101 (SiLink2 Master)	1061790
Plug connectors and cables			
	<ul style="list-style-type: none"> • Connection type head A: Female connector, M12, 5-pin, straight, A-coded • Connection type head B: Flying leads • Signal type: Sensor/actuator cable • Cable: 2 m, 5-wire, PUR, halogen-free • Description: Sensor/actuator cable, unshielded • Application: Zones with oils and lubricants, Drag chain operation, Robot 	YF2A15-020UB5XLEAX	2095617
	<ul style="list-style-type: none"> • Connection type head A: Female connector, M12, 5-pin, straight, A-coded • Connection type head B: Flying leads • Signal type: Sensor/actuator cable • Cable: 2 m, 5-wire, PVC • Description: Sensor/actuator cable, unshielded • Application: Zones with chemicals 	YF2A15-020VB5XLEAX	2096239
	<ul style="list-style-type: none"> • Connection type head A: Female connector, M12, 5-pin, straight, A-coded • Connection type head B: Flying leads • Signal type: Sensor/actuator cable • Cable: 5 m, 5-wire, PUR, halogen-free • Description: Sensor/actuator cable, unshielded • Application: Zones with oils and lubricants, Drag chain operation, Robot 	YF2A15-050UB5XLEAX	2095618
	<ul style="list-style-type: none"> • Connection type head A: Female connector, M12, 5-pin, straight, A-coded • Connection type head B: Flying leads • Signal type: Sensor/actuator cable • Cable: 5 m, 5-wire, PVC • Description: Sensor/actuator cable, unshielded • Application: Zones with chemicals 	YF2A15-050VB5XLEAX	2096240

	Brief description	Type	Part no.
	<ul style="list-style-type: none"> Connection type head A: Female connector, M12, 5-pin, straight, A-coded Connection type head B: Flying leads Signal type: Sensor/actuator cable Cable: 10 m, 5-wire, PUR, halogen-free Description: Sensor/actuator cable, unshielded Application: Zones with oils and lubricants, Drag chain operation, Robot 	YF2A15-100UB5XLEAX	2095619
	<ul style="list-style-type: none"> Connection type head A: Female connector, M12, 5-pin, straight, A-coded Connection type head B: Flying leads Signal type: Sensor/actuator cable Cable: 10 m, 5-wire, PVC Description: Sensor/actuator cable, unshielded Application: Zones with chemicals 	YF2A15-100VB5XLEAX	2096241
	<ul style="list-style-type: none"> Connection type head A: Female connector, M12, 5-pin, angled, A-coded Connection type head B: Flying leads Signal type: Sensor/actuator cable Cable: 2 m, 5-wire, PUR, halogen-free Description: Sensor/actuator cable, unshielded Application: Zones with oils and lubricants, Drag chain operation, Robot 	YG2A15-020UB5XLEAX	2095772
	<ul style="list-style-type: none"> Connection type head A: Female connector, M12, 5-pin, angled, A-coded Connection type head B: Flying leads Signal type: Sensor/actuator cable Cable: 2 m, 5-wire, PVC Description: Sensor/actuator cable, unshielded Application: Zones with chemicals 	YG2A15-020VB5XLEAX	2096215
	<ul style="list-style-type: none"> Connection type head A: Female connector, M12, 5-pin, angled, A-coded Connection type head B: Flying leads Signal type: Sensor/actuator cable Cable: 5 m, 5-wire, PUR, halogen-free Description: Sensor/actuator cable, unshielded Application: Zones with oils and lubricants, Drag chain operation, Robot 	YG2A15-050UB5XLEAX	2095773
	<ul style="list-style-type: none"> Connection type head A: Female connector, M12, 5-pin, angled, A-coded Connection type head B: Flying leads Signal type: Sensor/actuator cable Cable: 5 m, 5-wire, PVC Description: Sensor/actuator cable, unshielded Application: Zones with chemicals 	YG2A15-050VB5XLEAX	2096216
	<ul style="list-style-type: none"> Connection type head A: Female connector, M12, 5-pin, angled, A-coded Connection type head B: Flying leads Signal type: Sensor/actuator cable Cable: 10 m, 5-wire, PUR, halogen-free Description: Sensor/actuator cable, unshielded Application: Zones with oils and lubricants, Drag chain operation, Robot 	YG2A15-100UB5XLEAX	2095774
	<ul style="list-style-type: none"> Connection type head A: Female connector, M12, 5-pin, angled, A-coded Connection type head B: Flying leads Signal type: Sensor/actuator cable Cable: 10 m, 5-wire, PVC Description: Sensor/actuator cable, unshielded Application: Zones with chemicals 	YG2A15-100VB5XLEAX	2096217
Terminal and alignment brackets			
	Easy-clamp bracket for variable probe fastening, without mounting hardware	BEF-FL-PRBCFP-HLDR	2087299
Sensor Visualization			
	<ul style="list-style-type: none"> Product category: LED signal lamp Further functions: IO-Link signal lamp, Parameterization via IO-Link, Simple configuration directly via the SOPAS ET user interface, the engineering tool from SICK 	SLT060-0B010J700	6075938

Recommended services

Additional services → www.sick.com/CFP_Cubic

	Type	Part no.
Function Block Factory		
<ul style="list-style-type: none">• Description: The Function Block Factory supports common programmable logic controllers (PLCs) from various manufacturers, such as Siemens, Beckhoff, Rockwell Automation and B&R. More information on the FBF can be found <a _blank"="" href="https://fbf.cloud.sick.com target=">here.• Note: You can configure your function block at <a _blank"="" href="https://fbf.cloud.sick.com target=">Function Block Factory. As a login please use your SICK ID.	Function Block Factory	On request

SICK AT A GLANCE

SICK is one of the leading manufacturers of intelligent sensors and sensor solutions for industrial applications. A unique range of products and services creates the perfect basis for controlling processes securely and efficiently, protecting individuals from accidents and preventing damage to the environment.

We have extensive experience in a wide range of industries and understand their processes and requirements. With intelligent sensors, we can deliver exactly what our customers need. In application centers in Europe, Asia and North America, system solutions are tested and optimized in accordance with customer specifications. All this makes us a reliable supplier and development partner.

Comprehensive services complete our offering: SICK LifeTime Services provide support throughout the machine life cycle and ensure safety and productivity.

For us, that is “Sensor Intelligence.”

WORLDWIDE PRESENCE:

Contacts and other locations –www.sick.com