



Product designation	Solid state relay		
Product type designation	HS2B		
Type	Two-phase		
Input characteristics			
Control voltage	10...30VDC		
Operating voltage limits			
	Operating voltage pick-up	V	10
	Operating voltage drop-out	V	2
Input current at min...max voltage	mA	6...24	
Input reverse voltage	V	32	
Operating times			
Switching-on	Half cycle max		
Switching-off	Half cycle max		
Output characteristics			
Switching mode	Zero crossing		
Rated operating voltage	VAC	24...600	
Blocking voltage	V	1200	
Operational frequency (min...max)	Hz	45...65	
Rated operating current AC-51 (resistive load) at 40°C	A	50	
Rated operating current AC-51 (resistive load) at 55°C	A	50	
Heatsink for use at 40°C and 55°C at rated current AC-51	K/W	≤0.3	
Operational current min	A	0.05	
Non repetitive surge peak on state current t=10ms	A	1200	
Off state leakage current	mA	1	
On state output voltage drop	V	1.2	
Critical rate of rise of off-state voltage dv/dt	V/μs	500	
Input - Output isolation	V	4000	
Input - Output to metal base	V	4000	
I2t	A2s	7200	
Terminal characteristics			
Control terminals	Type	Screw	
Terminals tool	Blade 3.5mm		
Tightening torque control terminals			
	Nm	0.5Nm	
	Ibin	4.5	
Conductor section connectable (control terminals) with 1 or 2 wires min...max			
	AWG stranded	n°	28...12
	Flexible w/o lug	mm2	0.75...2.5
	Flexible c/w insulated spade lug	mm2	0.75...2.5
Load terminals	Type	Screw M5	
Load terminals tool	PZ2		
Tightening torque load terminals			
	Nm	2...3	
	Ibin	20.4	
Conductor section connectable (load terminals) with 1 or 2 wires min...max			

AWG stranded	n°	16...10
Flexible w/o lug	mm2	1.5...6
Flexible c/w insulated spade lug	mm2	1.5...6

Operating position

allowable Any

Fixing

Screw

Ambient conditions

Temperature

Operating temperature

min	°C	-55
max	°C	+90

Storage temperature

min	°C	-55
max	°C	+125

Dimensions

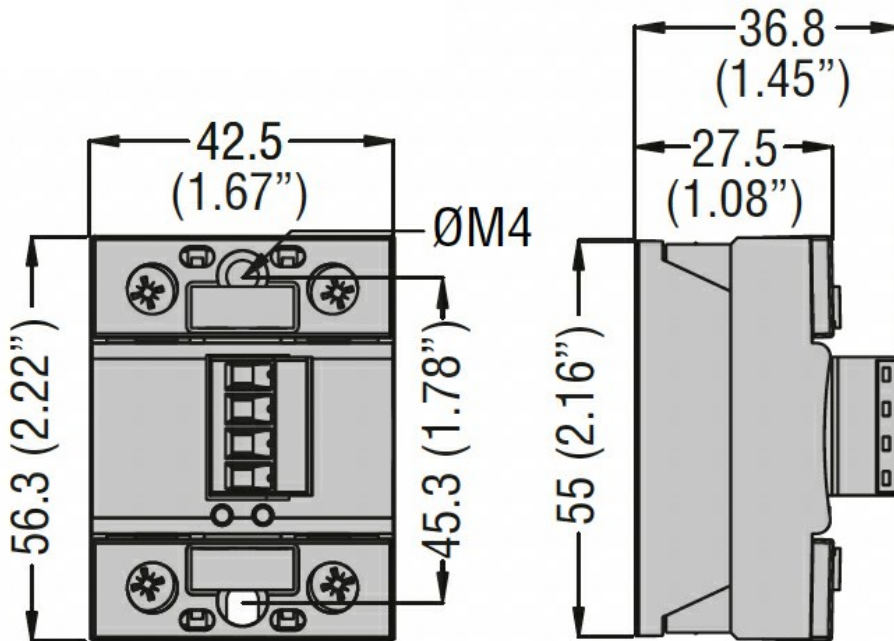

Certifications and compliance

Certifications

- IEC/EN/BS 60947-4-2
- IEC/EN/BS 60947-4-3
- IEC/EN/BS 62314
- IEC/EN/BS 6335-1

Compliance

- CSA
- cURus
- VDE

ETIM classification

EC000066 - Power contactor, AC switching