



Product designation

Roller centre  
push lever

Product type designation

KBC

**General characteristics**

Material

Housing

Polymer  
thermoplastic

Roller

Metal

**Contact characteristics**

Type of contact

2NC Snap action

Thermal current I<sub>th</sub>

A

10

IEC/EN 60947-5-1 designation

A600 Q300

Rated insulation voltage U<sub>i</sub>

V

690

Rated impulse withstand voltage U<sub>imp</sub>

kV

6

Insulation class

II

Short-circuit protection with fuse

Class/A

10 gG/SC  
QUICK FUSE

Switching speed

min

m/s

0.5

max

m/s

1.5

IEC Conventional free air thermal current I<sub>th</sub>

A

10

Resistance per pole (average value)

mΩ

<10

**Mechanical features**

Operating head fixing

Locking bayonet  
insert

Operating torque

N

6

lb

1.34

Tightening torque (Max)

Switch fixing

Nm

2.5

lbin

22.1

Contact terminals

Nm

0.8

lbin

7

Body lid screw fixing

Nm

0.8

lbin

7

Conductor section

AWG/Kcmil

min

16

max

14

IEC

min

mm<sup>2</sup>

1or 2

max

mm<sup>2</sup>

2.5

Cable connection	Self-releasing screw terminal
Cable entry	M20 on the bottom

**Operations**

Mechanical life	cycles	<10000000
Mechanical operation	cycles/h	3600

**Ambient conditions**

Temperature	Operating temperature	min	°C	-25
		max	°C	+70
	Storage temperature	min	°C	-40
		max	°C	+70

**Resistance & Protection**

IP degree	Terminals	IP20
	Body housing	IP65
Pollution degree		3

**Dimensions**

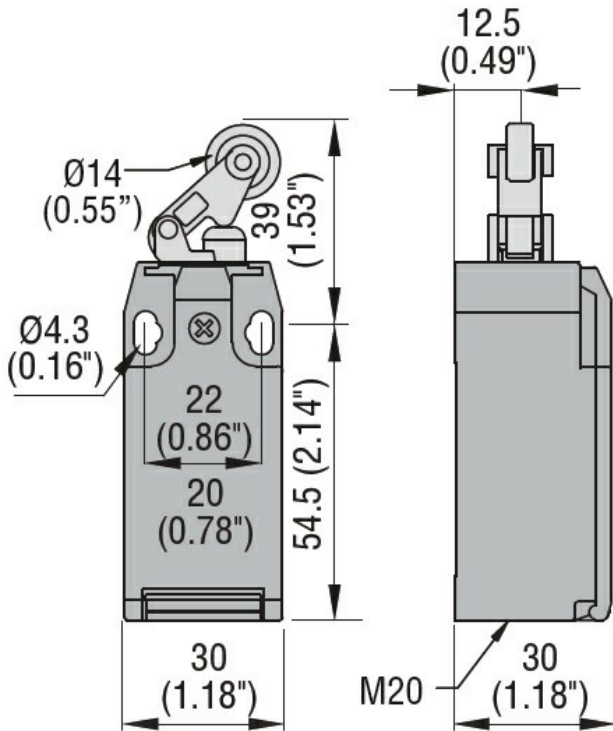

**Wiring diagrams**

## Snap action

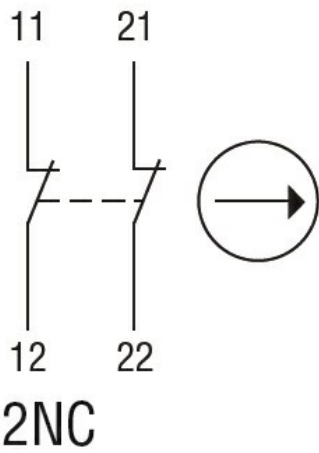

### Certifications and compliance

#### Compliance

CSA C22.2 n° 14  
EN 50047  
IEC/EN 60204-1  
IEC/EN 60947-1  
IEC/EN 60947-5-1  
UL508

#### Certificates

CCC  
cULus  
EAC

### ETIM classification

ETIM 8.0

EC000030 - End  
switch