



WTT12L-B3567

PowerProx

MULTITASK PHOTOELECTRIC SENSORS

SICK
Sensor Intelligence.



Illustration may differ



Ordering information

Type	Part no.
WTT12L-B3567	1072657

Other models and accessories → www.sick.com/PowerProx

Detailed technical data

Features

Functional principle	Photoelectric proximity sensor
Functional principle detail	Background suppression, Optical time-of-flight
Dimensions (W x H x D)	20 mm x 49.6 mm x 44.2 mm
Housing design (light emission)	Rectangular
Sensing range max.	50 mm ... 3,800 mm ¹⁾
Sensing range	100 mm ... 3,800 mm ^{1) 2)}
Type of light	Visible red light
Light source	Laser ³⁾
Light spot size (distance)	Ø 18 mm (3,800 mm)
Wave length	658 nm
Laser class	1 (IEC 60825-1 / CDRH 21 CFR 1040.10 & 1040.11)
Adjustment	Single teach-in button (2 x)

¹⁾ Object with 6 ... 90% remission (based on standard white, DIN 5033).

²⁾ Adjustable.

³⁾ Average service life: 100,000 h at T_J = +25 °C.

Mechanics/electronics

Supply voltage U_B	10 V DC ... 30 V DC ¹⁾
Ripple	< 5 V _{pp} ²⁾
Current consumption	70 mA ³⁾
Switching output	Push-pull: PNP/NPN ⁴⁾
Number of switching outputs	2 (Q ₁ , Q ₂) ⁴⁾
Switching mode	Light switching ⁴⁾
Output current I_{max}	≤ 100 mA
Response time	≤ 5 ms ⁵⁾
Switching frequency	100 Hz ⁶⁾
Analog output	-
Input	L/D = light/dark switching
Connection type	Cable with plug M12, 5-pin, 0.3 m ⁷⁾
Cable material	PVC
Conductor cross section	0.14 mm ²
Circuit protection	A ⁸⁾ B ⁹⁾ C ¹⁰⁾
Protection class	III
Weight	80 g
Housing material	Plastic, VISTAL®
Optics material	Plastic, PMMA
Enclosure rating	IP67
Ambient operating temperature	-35 °C ... +50 °C ¹¹⁾
Ambient temperature, storage	-40 °C ... +70 °C
Warm-up time	< 15 min ¹²⁾
Initialization time	< 300 ms
UL File No.	NRKH.E181493

¹⁾ Limit values. Operated in short-circuit protected network: max. 8 A.

²⁾ May not exceed or fall below U_V tolerances.

³⁾ Without load. At $V_S = 24$ V.

⁴⁾ Q₁, Q₂ = 2 switching thresholds, light switching.

⁵⁾ Signal transit time with resistive load.

⁶⁾ With light/dark ratio 1:1.

⁷⁾ Do not bend below 0 °C.

⁸⁾ A = V_S connections reverse-polarity protected.

⁹⁾ B = inputs and output reverse-polarity protected.

¹⁰⁾ C = interference suppression.

¹¹⁾ As of $T_a = 45$ °C, a max.load current $I_{max} = 50$ mA is permitted.

¹²⁾ Below $T_u = -10$ °C a warm-up time is necessary.

Safety-related parameters

MTTF_D	138 years
DC_{avg}	0 %

T_M (mission time)	20 years
-------------------------------------	----------

Classifications

eCl@ss 5.0	27270904
eCl@ss 5.1.4	27270904
eCl@ss 6.0	27270904
eCl@ss 6.2	27270904
eCl@ss 7.0	27270904
eCl@ss 8.0	27270904
eCl@ss 8.1	27270904
eCl@ss 9.0	27270904
eCl@ss 10.0	27270904
eCl@ss 11.0	27270904
eCl@ss 12.0	27270903
ETIM 5.0	EC002719
ETIM 6.0	EC002719
ETIM 7.0	EC002719
ETIM 8.0	EC002719
UNSPSC 16.0901	39121528

Dimensional drawing (Dimensions in mm (inch))

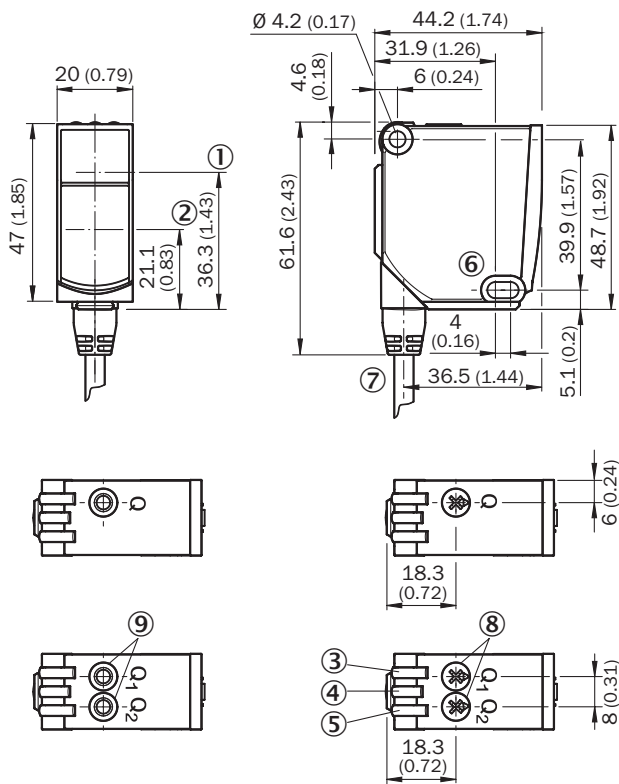

- ① Optical axis, sender
- ② Optical axis, receiver
- ③ LED indicator yellow: Status of received light beam
- ④ LED indicator green: power on
- ⑤ LED indicator yellow: Status of received light beam
- ⑥ Mounting hole, $\varnothing 4.2$ mm
- ⑦ Connection
- ⑧ Potentiometer
- ⑨ Single teach-in button

Connection diagram

Cd-286

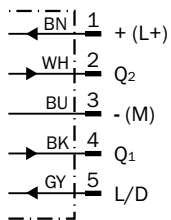

Characteristic curve

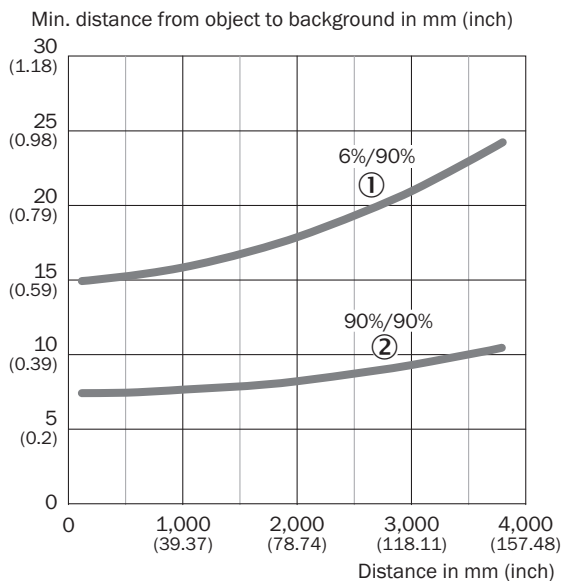

- ① Sensing range on black, 6% remission factor
- ② Sensing range on white, 90% remission factor

Light spot size

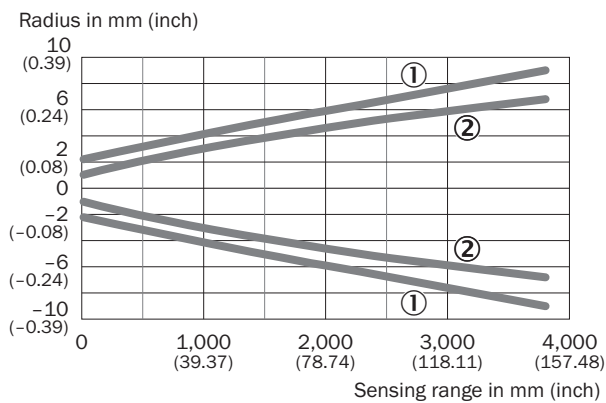

- ① Light spot horizontal
- ② Light spot vertical

Repeatability

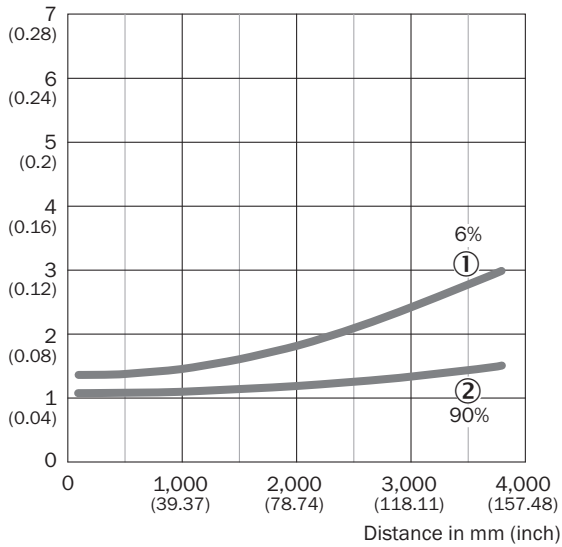

Repeatability in mm (inch)



- ① 6 % remission, on black
- ② 90 % remission, on white

Recommended accessories

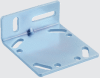
Other models and accessories → www.sick.com/PowerProx

	Brief description	Type	Part no.
Mounting brackets and plates			
	Mounting brackets	BEF-WTT12L	2078538
Plug connectors and cables			
	Head A: female connector, M12, 5-pin, straight, A-coded Head B: Flying leads Cable: Sensor/actuator cable, PVC, unshielded, 5 m	YF2A15-050VB5XLEAX	2096240
	Head A: male connector, M12, 5-pin, straight Cable: unshielded For field bus technology	STE-1205-G	6022083

SICK AT A GLANCE

SICK is one of the leading manufacturers of intelligent sensors and sensor solutions for industrial applications. A unique range of products and services creates the perfect basis for controlling processes securely and efficiently, protecting individuals from accidents and preventing damage to the environment.

We have extensive experience in a wide range of industries and understand their processes and requirements. With intelligent sensors, we can deliver exactly what our customers need. In application centers in Europe, Asia and North America, system solutions are tested and optimized in accordance with customer specifications. All this makes us a reliable supplier and development partner.

Comprehensive services complete our offering: SICK LifeTime Services provide support throughout the machine life cycle and ensure safety and productivity.

For us, that is “Sensor Intelligence.”

WORLDWIDE PRESENCE:

Contacts and other locations –www.sick.com