

Part number

MHP 06 LS220



Surface mounting housing, C-TYPE series, with 1 lever, M20 x 2 cable entry, size "44.27", with metal cover

Product description

Product type	Surface mounting housing
Series	C-TYPE
Closing type	With 1 lever
Size	Size 44.27
Cable entry	With cable entry M20 x 2
Specification	With metal cover

Technical data

IP degree of protection IP65

Further technical details

Weight	258,00 g
Operating temperature range (min, max)	-40°C...+125°C

Material properties

Other materials	Lever: Stainless steel, polyamide (PA) Gasket: NBR
Colour	RAL 7040 grey
RoHs conformity	Compliant
China RoHs - EFUP	E
REACH SVHC substances	No

Approvals / Standards

Certifications	DNV, BV
UL	ECBT2
cUL	ECBT8

General ordering information

EAN13 code	8015747054133
eCl@ss 8.1	27440202
ETIM 7.0	EC000437

Packaging Information

Packaging length	475,00 mm
Packaging height	160,00 mm
Packaging width	140,00 mm
Packaging weight	2,93 kg
Packaging volume	10,64 dm ³
Packaging description	Carton box
Packaging quantity	10 Pcs
Packaging EAN code	8015747054140
Sub-packaging weight	1,47 kg
Sub-packaging description	Plastic packaging
Sub-packaging quantity	5 Pcs
Sub-packaging EAN barcode	8015747054157

Part number

MHP 06 LS220



Catalogue drawings

CHP L CAP L - MHP L MAP L

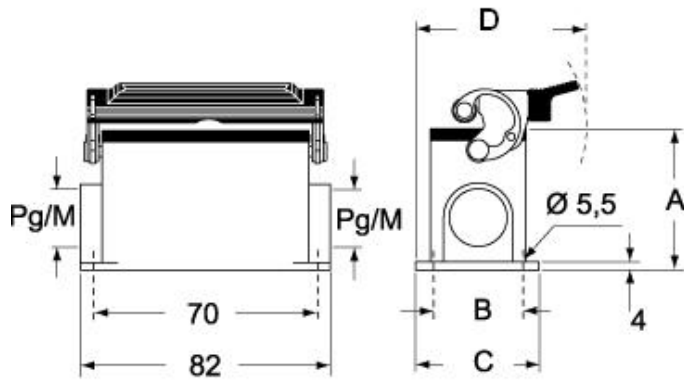

CHP LS CAP LS - MHP LS MAP LS

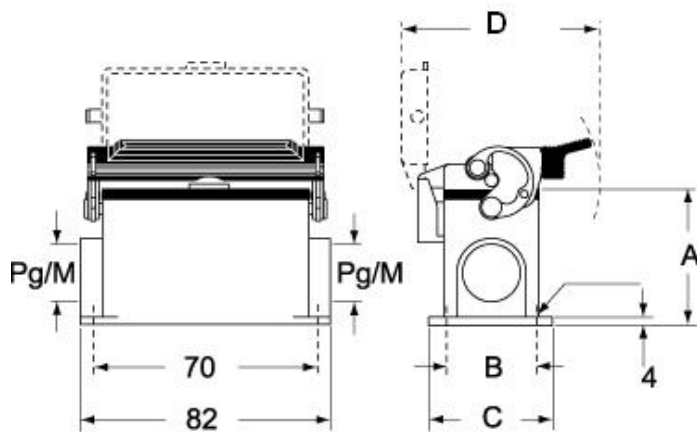

Notes

Dimensions shown in mm are not binding and may be changed without notice.