

SLIM STANDALONE INTERFACES

USB-DMX 512 & 1024 CHANNELS

V.1.0

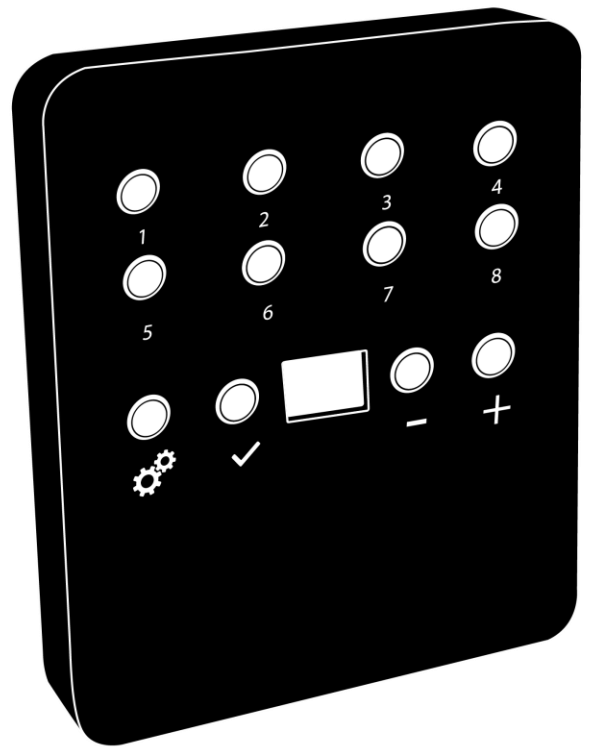
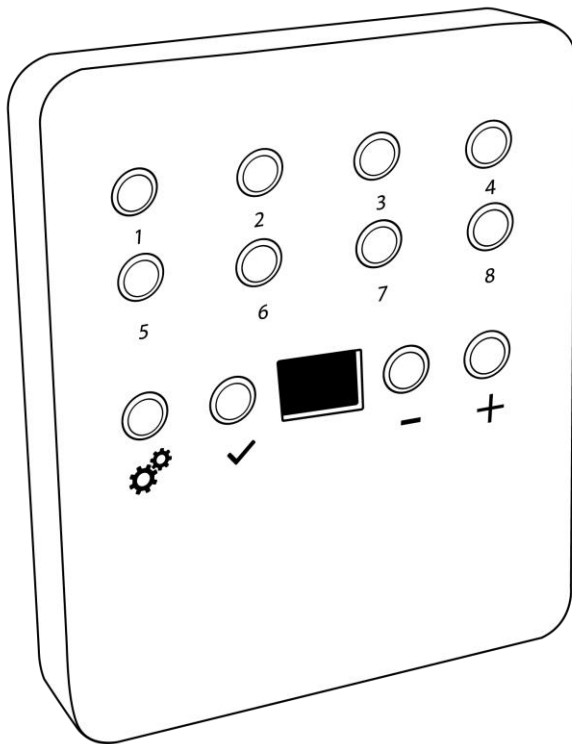

SUMMARY

Hardware technical specifications	3
Front Face of the 512 / 1024 channels interfaces	4
Bottom Face of the 512 / 1024 channels interfaces	4
Back Face of the 512 / 1024 channels interfaces.....	5
Interface buttons and display features	6
Zone Mode (1024 Channel Interfaces Only)	8
Zone configuration in the software.....	8
Stand alone Interface Triggers.....	10
Switch to Stand alone mode.....	10
Interface Mode settings	10
LED buttons trigger	13
Contact wiring and connections with RJ45 Pins.....	14
Triggering commands	15
IR Remote control unit and IR receiver.....	16
DMX IN trigger connection	17
DMX IN triggers via another DMX signal in standalone.....	18
Setup DMX in mode in software use	19
Time triggers with clock and calendar	21
Save and recover the last scene after the power cut off:	23
Scene trigger priorities:.....	23
Dmx merging in standalone	24
Configuration of the Master/Slave interfaces.....	25
Setting of the Master/Slave interfaces.....	26
SD Card	27
Battery	27
Wall mounting instructions.....	27
For Europe and Asia Standard: 60mm center to center distance.....	28
For America standard: 84mm center to center distance	28
Dimensions of the interface.....	29
Bottom Face.....	29
Side faces	29
Back face	29
Multiple usb devices connections	30
Standard DMX 512 installation.....	31
Recommended DMX512 installation.....	31

HARDWARE TECHNICAL SPECIFICATIONS

Input	USB 2.0 via Mini USB
Number of DMX Outputs (512/1024)	Up to 512 / 1024 on 5 Screws terminal Pins
DMX Modes (512)	2x512 (Splitter, PC + Stand Alone) or 512 in/out (PC mode)
DMX Modes (1024)	2x512 ,1024 or 512 in/out (PC + Stand Alone)
DMX Input (512)	Yes (PC only, DMX record, DMX trigger)
DMX Input (1024)	Yes (PC and Stand Alone mode, DMX record, DMX trigger)
Stand Alone Mode (512)	Yes, 2x512 (splitter), fine DMX channels (16 bits)
Stand Alone Mode (1024)	Yes, 2x512 (splitter), 1024, 512 in/out, fine DMX channels (16 bits)
Multiple Zone (512)	No, 1 Zone, can play 1 scene per time
Multiple Zone (1024)	Yes, 5 Zones, can play 5 different scenes per time
Stand Alone DMX Merging	Yes, merge several interfaces to play different Zones together
Internal Memory	Yes (4 Mb)
External Memory	Yes, SD card slot included
Memory Capacity	20000 steps with 16 ch., 6000 steps with 512 ch., 3000 steps with 1024 ch.
Real Time Clock - RTC	Yes, Time and calendar triggers (minutes, hours, week, days, month)
Trigger buttons	Yes, 8 buttons with Blue status LED
Option Buttons	Yes, 4 buttons (Mode, Valid, Next, Previous)
Mode Buttons	Yes, Scene and Page selections, Speed, General Dimmer, custom colors
Dry Contact Triggers	Yes (5 contacts port on 3,3V or 5V)
Infra-red Receiver	Yes, external IR PCB and IR remote control available in option
Infra-red Options	10 scene selection, scene speed, general dimmer and next scene
Light intensity Triggers	Yes, external PCB with Light sensor available in option
Master/Slave	Yes, synchronize and connect up to 32 interfaces together in stand alone
CPU's technology	32 bits
Dimensions	H : 20mm(0.79in) / W : 128mm(5.04in) / D : 109mm (4.29in)
Weight	0.2 Kgs
Package total weight	0.41 Kgs
Power Input	5V to 24V DC, 0.5A max on DC connectors, 5V, 0.5A via USB
Power / Consumption	0.3 to 0.5W
High Voltage Protection	Yes
Housing	Black or White with 4 mounting holes, ABS Plastic
IP rating	IP20
Place of Use	Indoor
Storage	Keep in dry place
Compatibility	8 and 16 bits DMX fixtures
Operating Temperature	- 25 to +70 C°
Certifications	CE, RoHS, Fcc
International Warranty	Yes, 3 years

Software features:

LED Player	512/1024 channels DMX + Stand Alone mode, Live Board mode
Studio DMX 3D viewer	Mode Full
Pro DMX	Yes, 1024 channels, full mode, 30 minute loop of Audio and VideoTimeline
Art-Net output from PC	Yes, 1 or 2 Universes (DMX + Artnet)
Wi-Light 2016 App	Yes, can control LED Player and Pro DMX with a WIFI connection
System Compatibility	Windows, MAC Os X (10.6 and higher) and Linux (64 Bits)
Free software updates	Yes

Package Content: 1 USB cable + 1 USB to DMX Interface



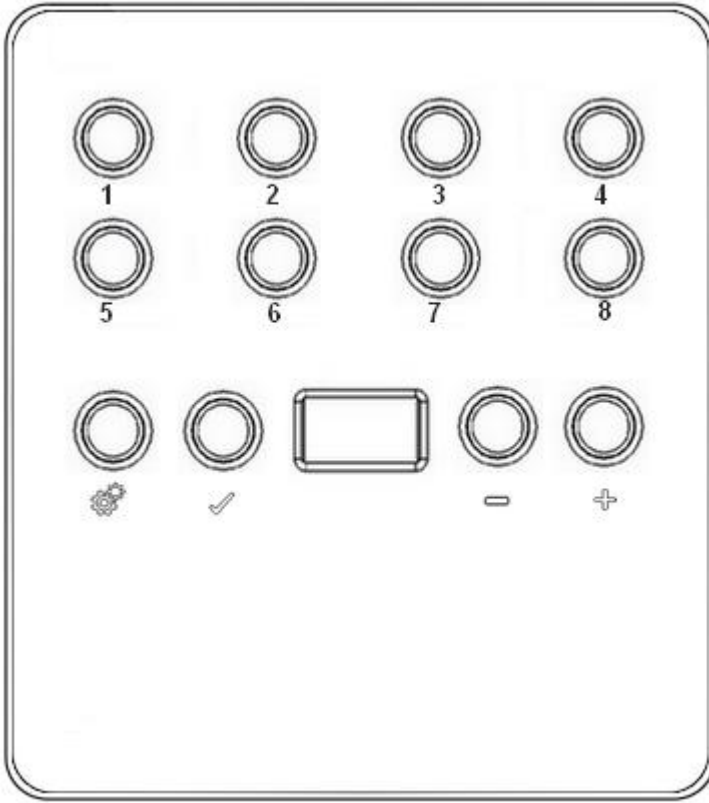

FRONT FACE OF THE 512 / 1024 CHANNELS INTERFACES



Scene triggering buttons:

- 1: Scene 1 On/Off
- 2: Scene 2 On/Off
- 3: Scene 3 On/Off
- 4: Scene 4 On/Off
- 5: Scene 5 On/Off
- 6: Scene 6 On/Off
- 7: Scene 7 On/Off
- 8: Scene 8 On/Off

Command buttons:

-  : Mode selection (Trigger, Page, Color, Speed, Dimmer, Zone)
-  : Valid Choice / Color Off
-  : Decrease values
-  : Increase values

Display:

7-segments LED display

BOTTOM FACE OF THE 512 / 1024 CHANNELS INTERFACES



Mini USB connector and USB power connector

5 DC Volts only; 0,15-1 A.

Micro SD Port

BACK FACE OF THE 512 / 1024 CHANNELS INTERFACES

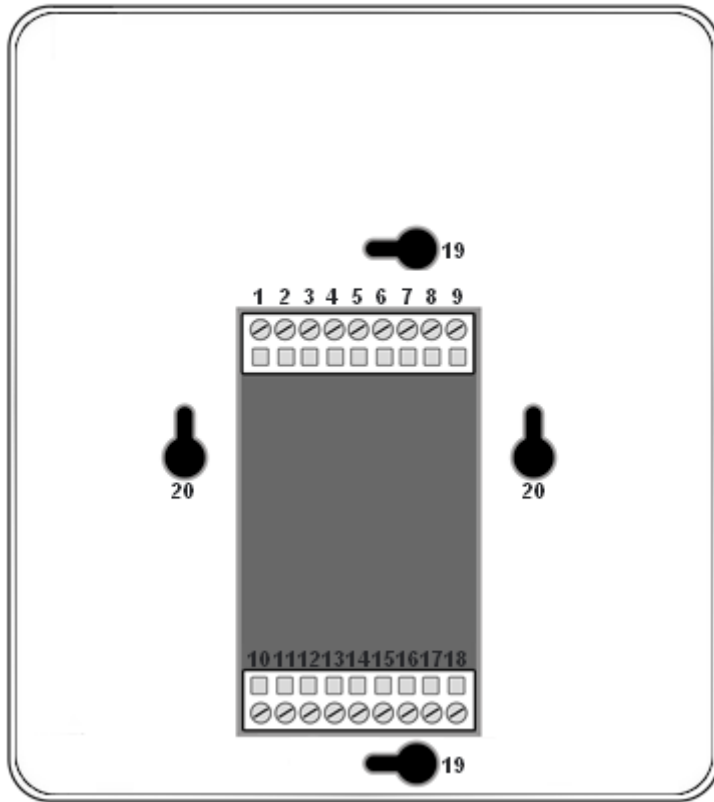

External connectors:

- 1: External input power 9-36V
- 2: GND
- 3: External trigger A
- 4: External trigger B
- 5: External trigger C
- 6: External trigger D
- 7: External trigger E
- 8: Master/Slave Data
- 9: Master/Slave Clock
- 10: 5V. DC External trigger voltage
- 11: GND
- 12: Infra Red signal
- 13: Light Sensor
- 14: DMX2 - data
- 15: DMX2 + data
- 16: DMX Ground
- 17: DMX1 - data
- 18: DMX1 + data

External wall mounting:

- 19: America standards
- 20: Europe + Asia standards

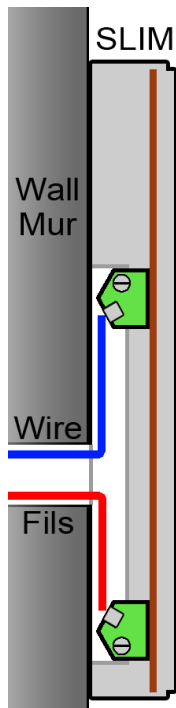

Mode selection button

Press the Button  to select one of the available mode : Scene triggers (SA), Page (PA), Color (Co), Speed (SP), Dimmer mode (dl) or Zone (Zo).

Valid Button

Press the button  to validate your choice or turn off the current color selection.

Next/Previous, +/- Scene buttons

Scene trigger mode: Select the scene number with + or – buttons, then press Valid to confirm to play the selected scene from 01 to 255. The scene number will flash several time to confirm your selection.

With scene 00 nothing is playing

Page Mode: Select the scene page with + or – buttons from P0 to P9, then choose the scene available in the current page with the 8 buttons.

Color mode: From the 8 buttons, select one of the 8 customized color or choose the color of the color wheel from 00 to 99 with + or – buttons. Press Valid button to turn off the current color or recall the last color from the color wheel.

Speed Mode: Increase or decrease the Speed of the current scene with + or – buttons. Values are from -9 to +9.

Dimmer Mode: Increase or decrease the general intensity (dimmer + RGB) of scenes and colors with + or – buttons. Values are from -9 to +9.

Zone Mode: Select the zone with + or – buttons (Zone A to E and global Zone), then choose the scene available in the current zone with the 8 buttons.

Blue LED buttons

Push one of the 8 trigger buttons to play a scenes in memory from the Scene trigger mode, Page mode and zone Mode.

Push again the buttons with blue LED to stop the current scene.

In color mode push a button to trigger a personalized colors. Push again to stop it.

LED display operations and meaning :

The LED Display shows the number of the current scene, page, color, selected modes, speed/dimmer values, selected zone and the update firmware mode.

There are different displays according to the selected mode:

PC: The interface is connected to the computer and communicating with the software. The interface is controlled by software.

SA: Scene trigger mode is running. By default then no scene is playing, all DMX channels are set to 0. In Scene trigger mode, the LED display gives the current scene number from 01 to 255. The 00 value is Black-out and the DMX interface send nulls (0x00) on all output.

PA: Page mode, it allows to switch between 10 pages of 8 buttons to triggers scenes directly. In page mode, the display indicates the page number P0 to P9.

Co: Color mode, to play some customized colors on RGBW channels. In color mode, the display indicates the color number from C1 to C8.

SP: Speed mode, increase or decrease the current scene speed. In speed mode, the display indicates the speed of the current scene, values from -9 to 9.

dl: Dimmer mode, increase or decrease the general intensity and dimmer of scene and customized colors. In dimmer mode, the display indicates the general intensity, values are from -9 to 9.

Pr: Programming memory Mode, Pr is display when the interface is writing a show in memory.

Zo: Zone mode is selected. After programmed the interface memory the zone A is selected by default. In zone mode, the LED display gives the current Zone : General, A, B, C, D, E.

Zone A to D display : 

General Zone display : 

The LED Display switch between the current zone and the running scene number every 3 seconds.

bl: Update firmware mode, when a new firmware is writing in memory. In update firmware mode, the display will flash during the firmware update. Do not disconnect the interface during this mode.

ZONE MODE (1024 CHANNEL INTERFACES ONLY)

1024 channels interfaces allows to play 5 zones at the same time in stand alone mode.

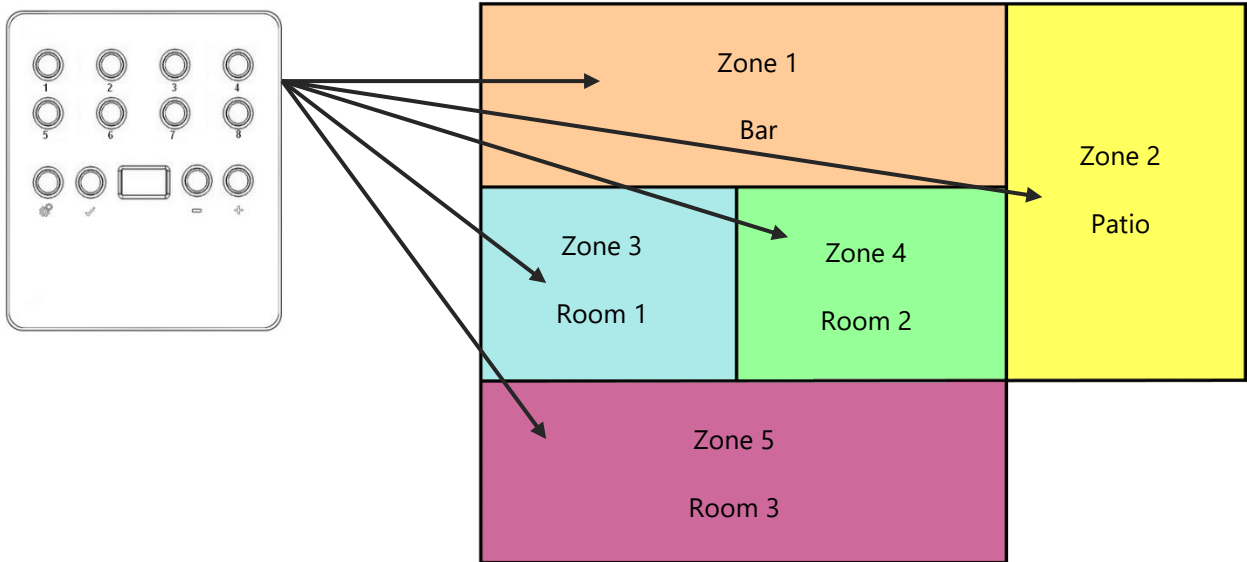

ZONE CONFIGURATION IN THE SOFTWARE

In the edition mode :

Click on + to add zones

The zone window can be display by clicking on the « Zone » button

In the zone window, move the central bar to define the zone parameters, it is also possible to choose manually the zone range in the fields.

Make sure your DMX Patch and fixtures addresses are corresponding to your Zones.

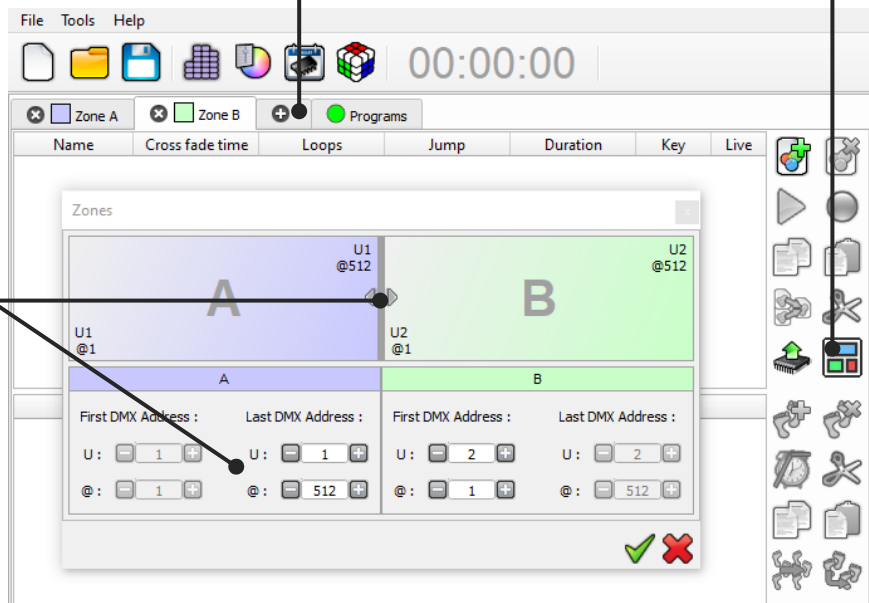

When zones are defines, you need to create scenes in the corresponding tab :

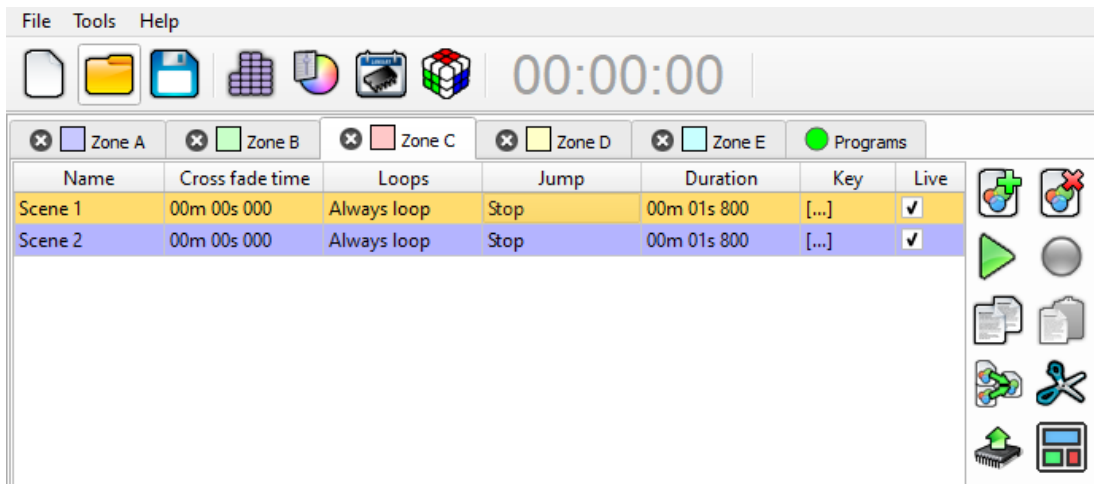

In Stand alone Mode :

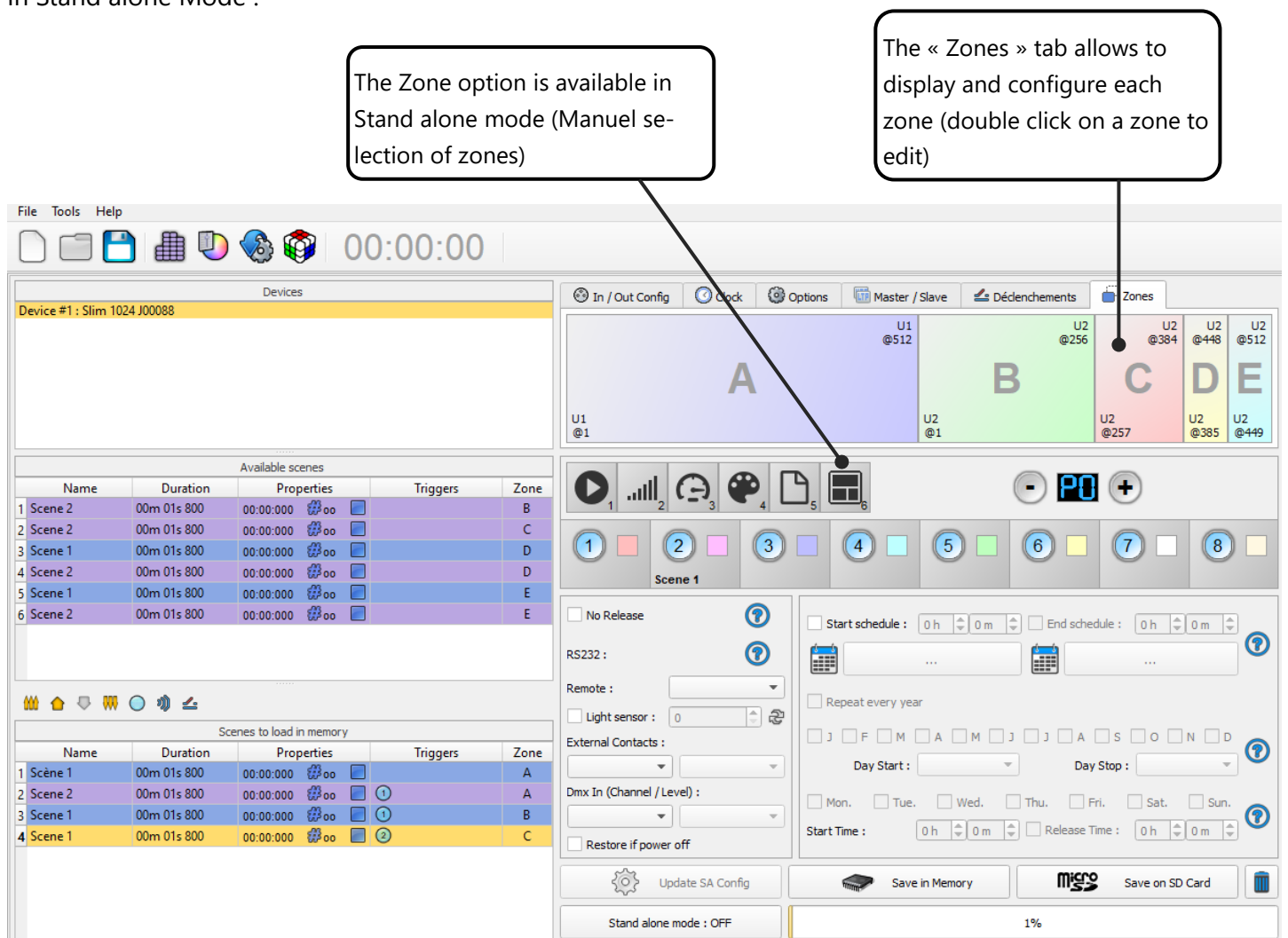

STAND ALONE INTERFACE TRIGGERS

The Stand Alone mode of the software enable to configure and personalize all the triggers.

The information will be directly saved in the DMX interface memory with the memory writing function.

SWITCH TO STAND ALONE MODE

When the device isn't connected to the software or has just been powered, it enters in Stand Alone mode after five (5) seconds.

INTERFACE MODE SETTINGS

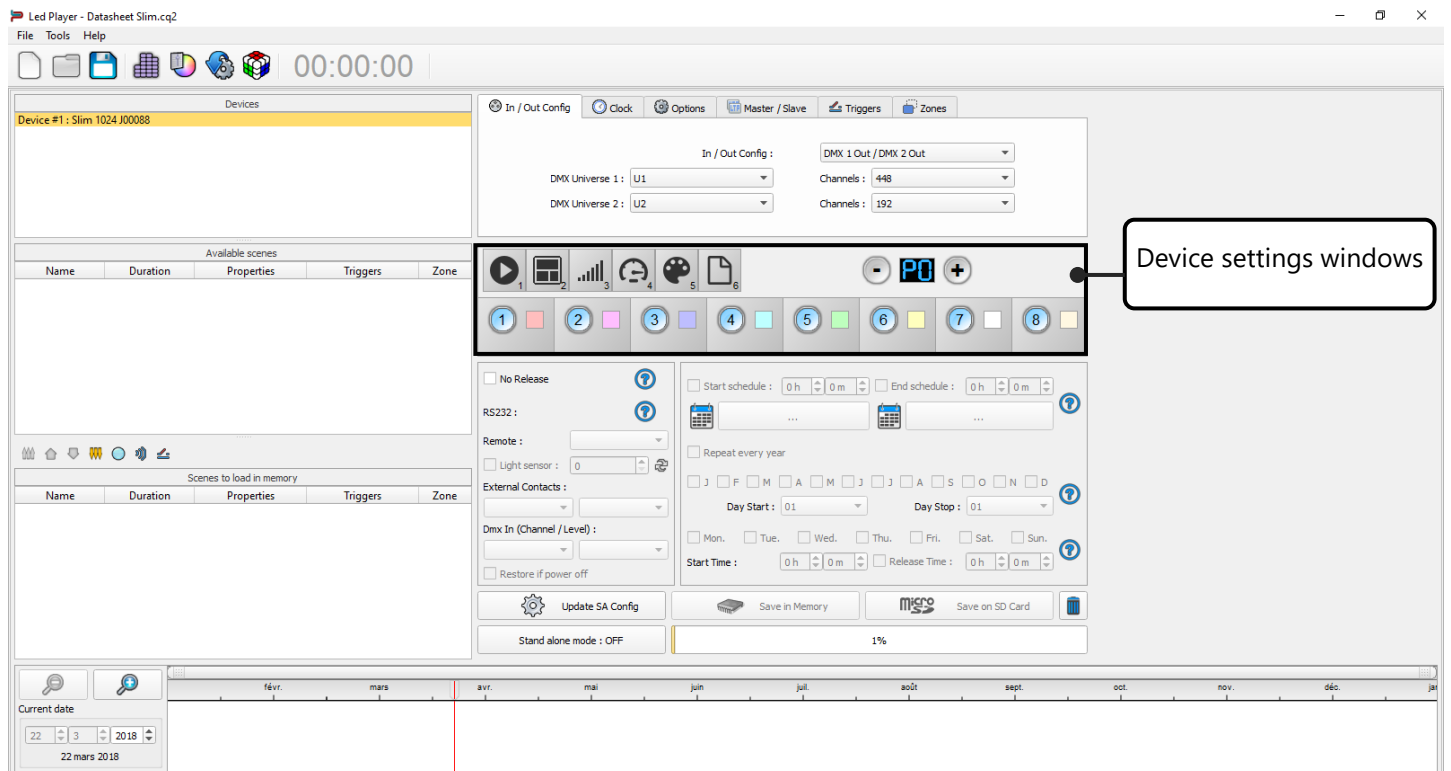

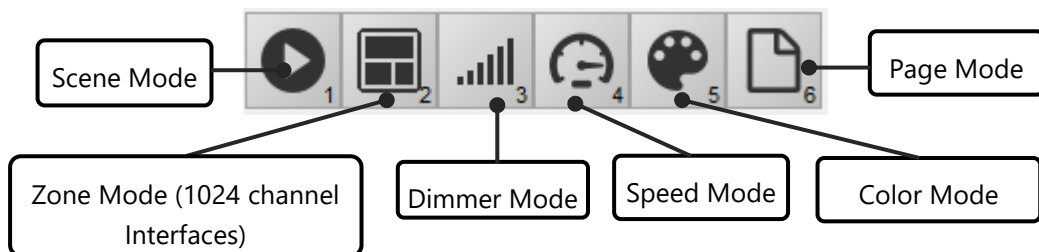
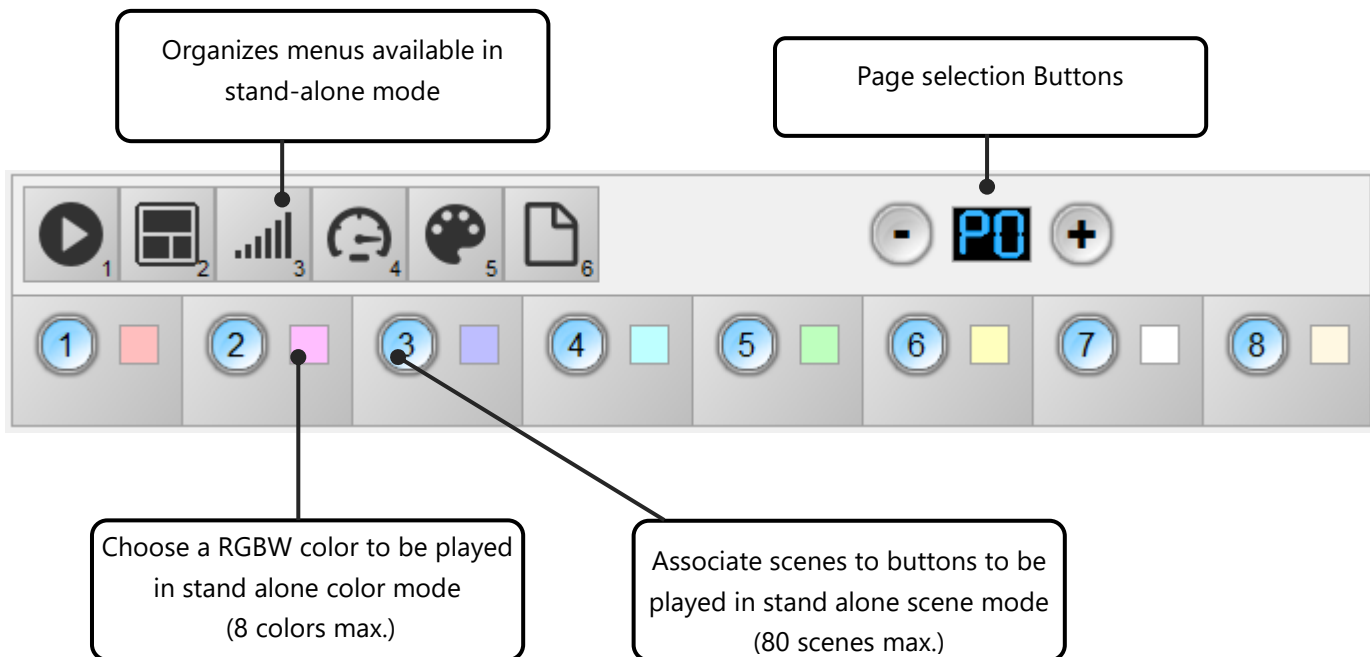

It is possible to personalize the mode that you want to use in Stand Alone.

From the mode icons, you can right click to Add or Remove a mode. Drag and drop a mode in the list to order them accordingly to your need.

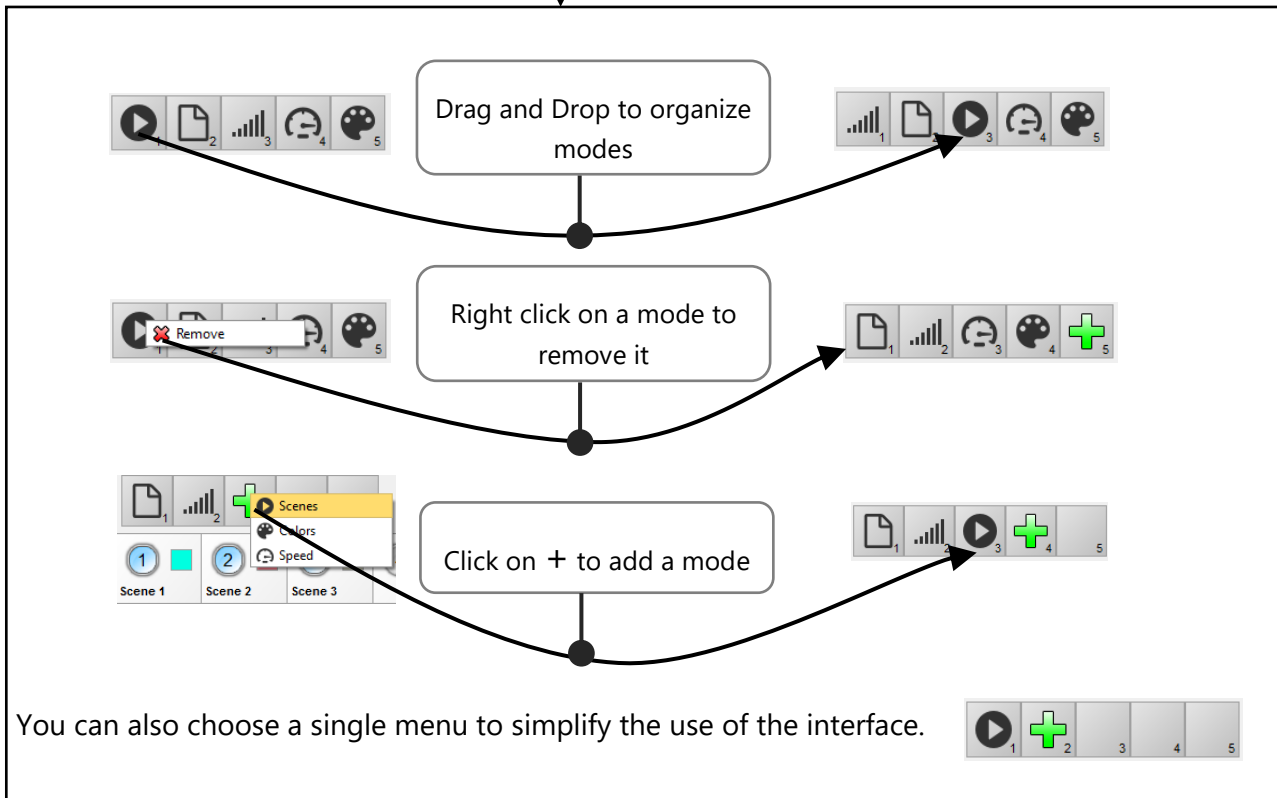
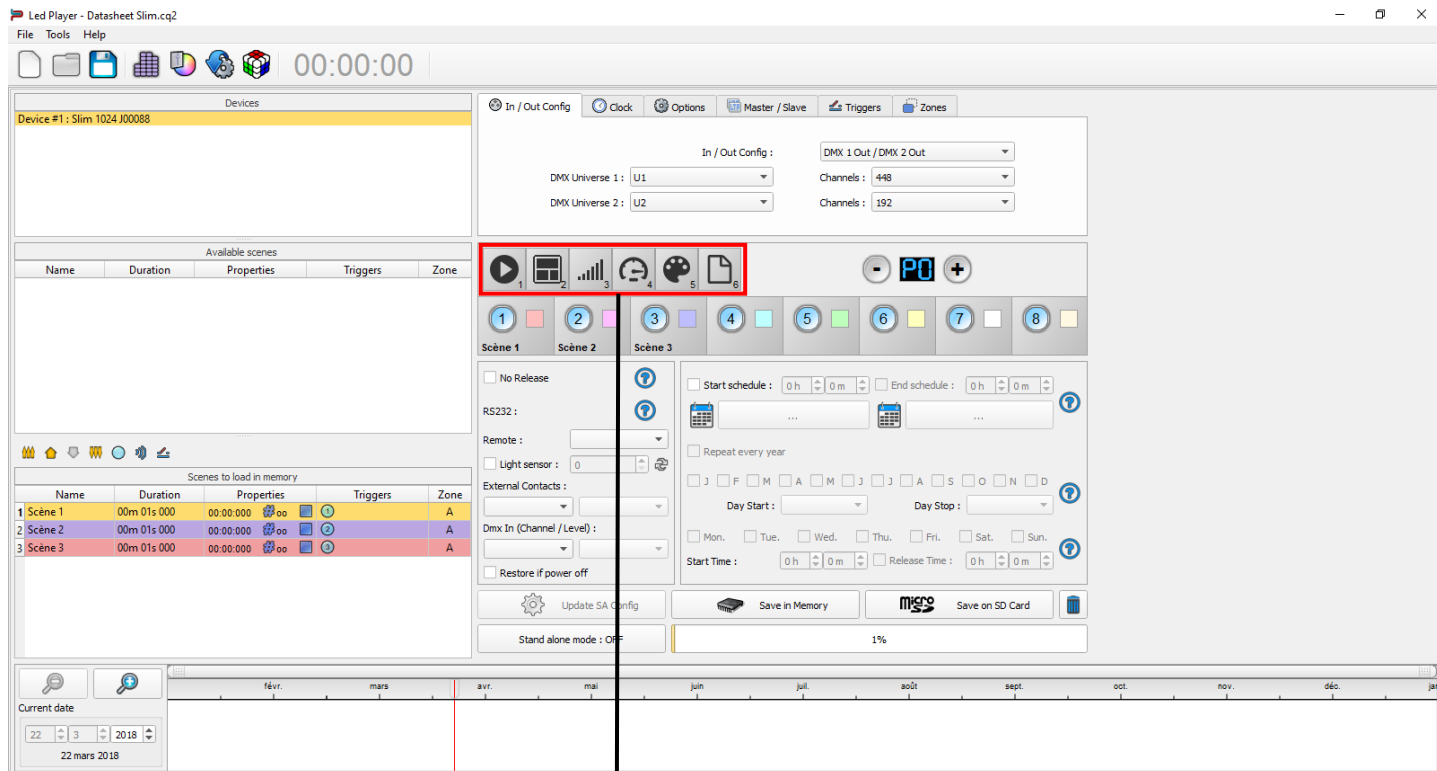

LED BUTTONS TRIGGER

Standalone mode offers 8 buttons that represents the interface LED buttons. From the scene list of the standalone mode, you need to drag and drop a scene on any button to assign a button number.

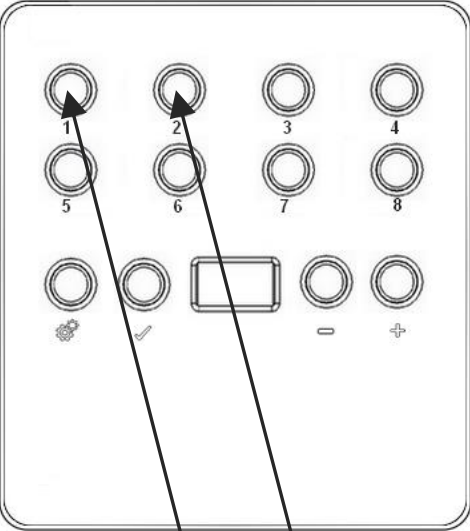

The diagram shows a 3x4 grid of 12 circular buttons. The top two rows contain buttons numbered 1 through 8. The bottom row contains a gear icon, a pencil icon, a rectangular button, a minus sign, and a plus sign. Arrows point from buttons 1 and 2 in the diagram to buttons 1 and 2 in the software interface below.

The software interface shows a table of scenes to load in memory:

Name	Duration	Properties	Triggers	Zone
1 Scène 1	00m 01s 000	00:00:000	oo	A
2 Scène 2	00m 01s 000	00:00:000	oo	A
3 Scène 3	00m 01s 000	00:00:000	oo	A

Below the table is a control panel with 8 buttons numbered 1 to 8. Buttons 1, 2, and 3 are assigned to 'Scène 1', 'Scène 2', and 'Scène 3' respectively. A callout box with the text 'Drag and Drop a scene to a button' has an arrow pointing to button 1.

Other interface elements include a 'Scenes to load in memory' table, a 'Stand alone mode : OFF' indicator, and a progress bar at 1%.

It's possible to replace a scene by another one or to remove it by pulling it out of the list.

You can also setup a color to each button and play this color in the color mode, click on color square to set your own color.

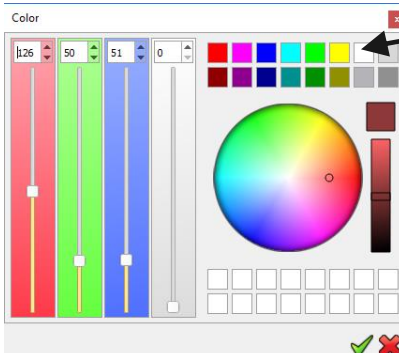

The color selection interface features three vertical sliders for red, green, and blue, with values 126, 50, and 51. A color wheel is positioned to the right of the sliders. A callout box with the text 'Click and set the desired color' has an arrow pointing to a color square in the top right corner of the interface.

CONTACT WIRING AND CONNECTIONS WITH RJ45 PINS

The 5 external contacts are located on screw terminal. You can use the 5 dry contacts to trigger 5 scenes via external relay. To have more triggers you must use a multiplexed system to get a maximum of 31 contacts as following:

Multiplex the trigger could give 31 triggers combinations.

External Contact Closures can be done only when Pin 3, 4, 5, 6, 7 are connected to Pin 10 (5 V. DC). (up to 31 triggers)

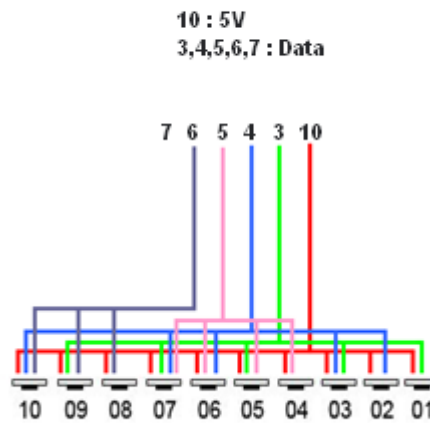
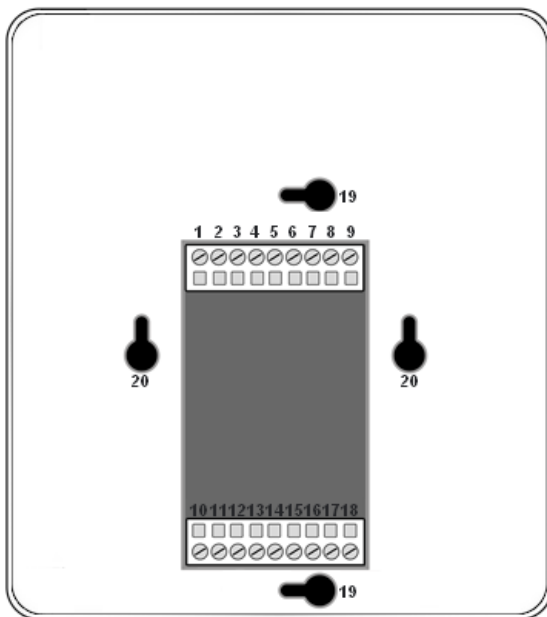

Pin Table :

- Trigger 01 = Pin 3
- Trigger 02 = Pin 4
- Trigger 03 = Pin 3 + 4
- Trigger 04 = Pin 5
- Trigger 05 = Pin 3 + 5
- Trigger 06 = Pin 4 + 5
- Trigger 07 = Pin 3 + 4 + 5
- Trigger 08 = Pin 6
- Etc...

By selecting a scene in the list, it's possible to choose the external contact number (from 01 to 127) to trigger the scene.

By default, the interface gives 7 external contacts (01, 02, 04, 08, 16, 32, 64). To obtain 127 external contacts, you have to use a de-multiplexing interface in order to go use the other possible combinations.

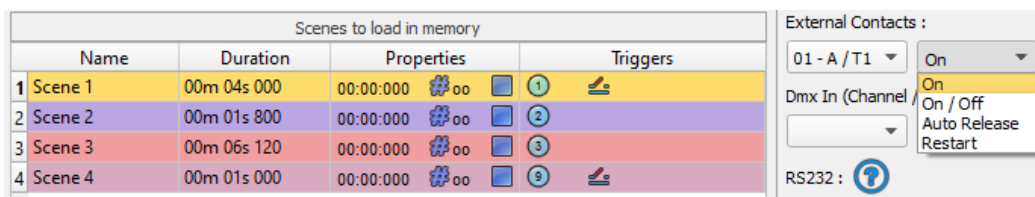

Several trigger options are available for externals contacts triggers:

On : Activate the contact only allow you to play the scene.

On/Off : Activate the contact allow you to play and stop a scene. Each trigger action will invert the state of the scene (start/stop).

Auto Release: The scene plays while the contact is activated. Keep the contact activated to play the scene, when the contact is released the scene stop.

Restart : Activate the contact will restart the scene from its beginning automatically. If the scene is off already, then it will play.

TRIGGERING COMMANDS

External contacts can also trigger commands in stand alone mode. >From the Triggers tab you can select a contact for each action : Dimmer + , Dimmer -, Blackout, Speed +, Speed -, Pause, Scene +, Scene - and Area.

It is not possible to use the same trigger for scene and command, in this case, the scene contact has the priority or the scene will loose its contact trigger information after choose the contact from the Trigger command tab.

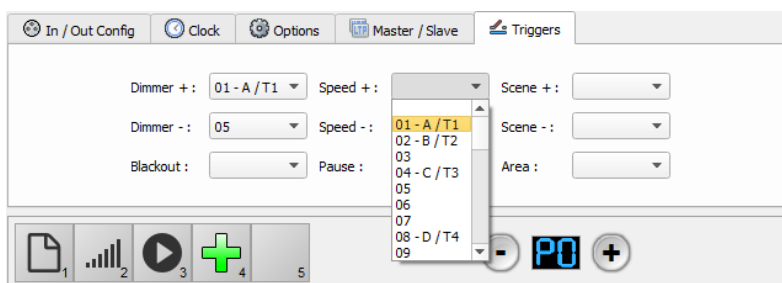

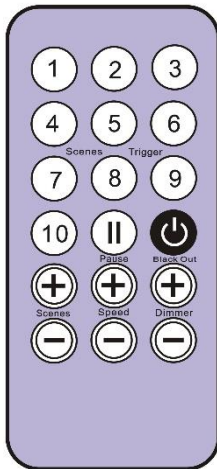

Button 1 to 10 must be assigned to a scene via the software.

Each button can trigger a different scene. With the remote control, a scene cannot be stop directly with the assigned button. To stop it you must press the Stop/Black Out button or trigger another scene.

Pause button to freeze the current scene to its actual state.

Stop/Black Out button to stop the current scene and play the empty scene number 00. All DMX channels are set down to 00 levels.

+/- for scene trigger. Select the next or previous scene automatically. You don't need to hold the button to validate and play a scene. The next or previous scene will play directly after selected.

+/- for Scene speed. Increase or decrease the speed of the current scene. A different speed can be chosen separately for each scene.

+/- for General dimmer. Increase or decrease the RGB, CMY and dimmer channels of the fixtures. The CMY, RGB, Dimmer channels are defined in the Profile of the fixture.

To use the IR remote control, the external IR receiver must be connected to the screw terminal (Pins 10,11,12).

The cable distance is about 20 meters maximum.

IR PCB Pin assignment:

- With RJ45 cable use pins 8 = Ground; 4 = IR Data ; 7 = 5V DC.
- With T. Block use pins: 4 = IR Data; 7 = 5V DC; 8 = Ground.

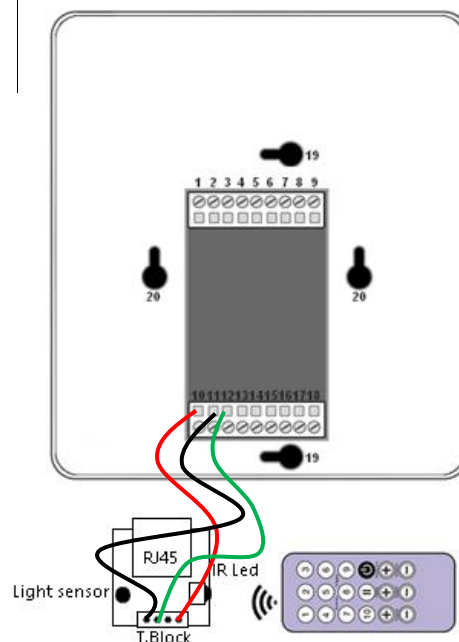

In the software go to Stand Alone Mode and use the Triggers options to assign a remote button to a scene. Standalone mode offers up to 10 triggers with the Infrared remote.

By selecting a scene in the list, it's possible to choose the remote button number (from 01 to 10) to trigger the scene.

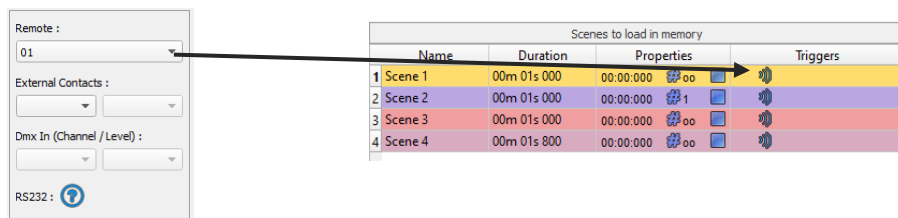

DMX IN TRIGGER CONNECTION

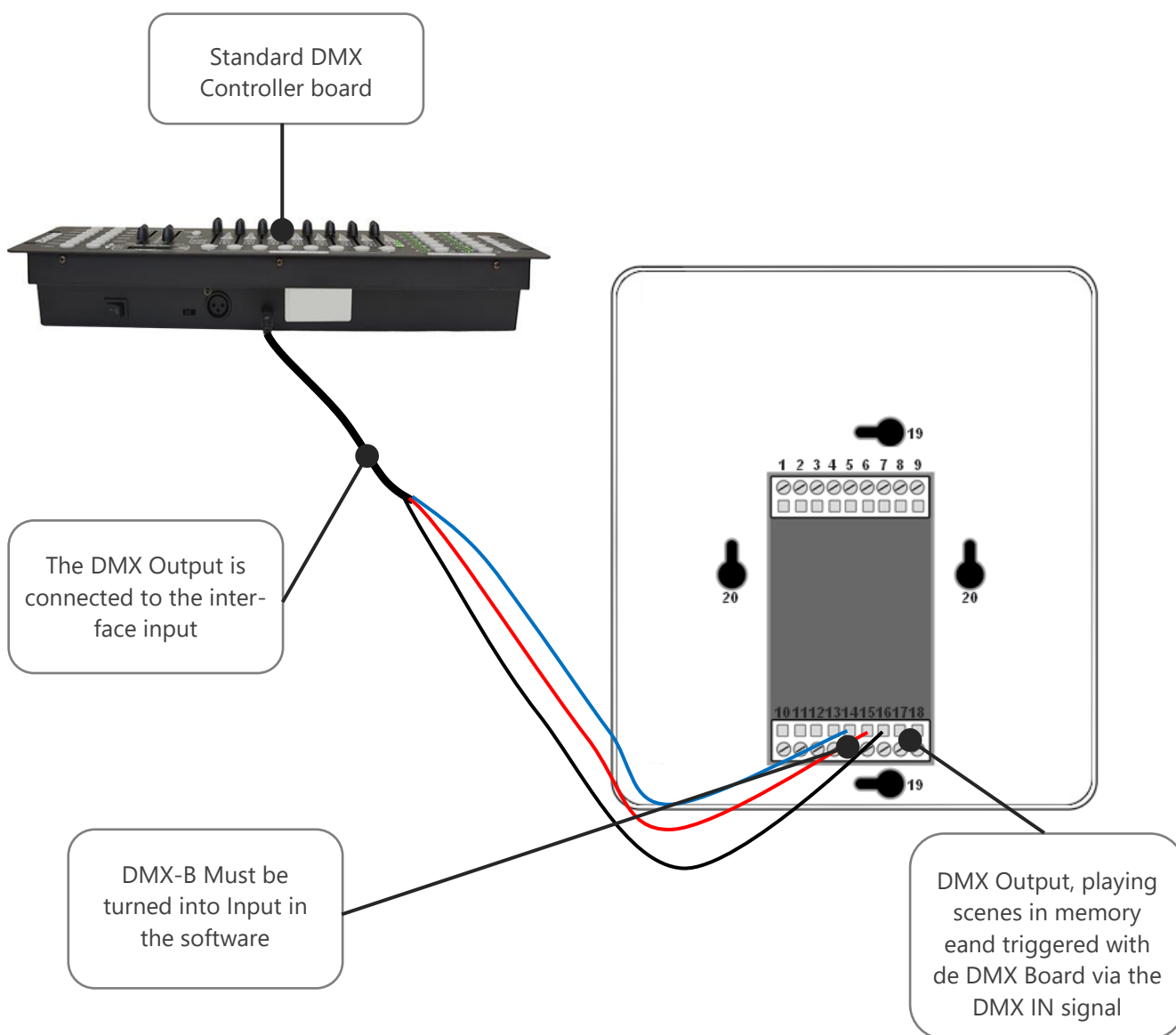

DMX IN TRIGGERS VIA ANOTHER DMX SIGNAL IN STANDALONE

DMX in trigger in stand Alone available only with 1024 interfaces.

In stand alone window set In / Out Config as DMX 1 Out/DMX 2 In and select the DMX Out universe

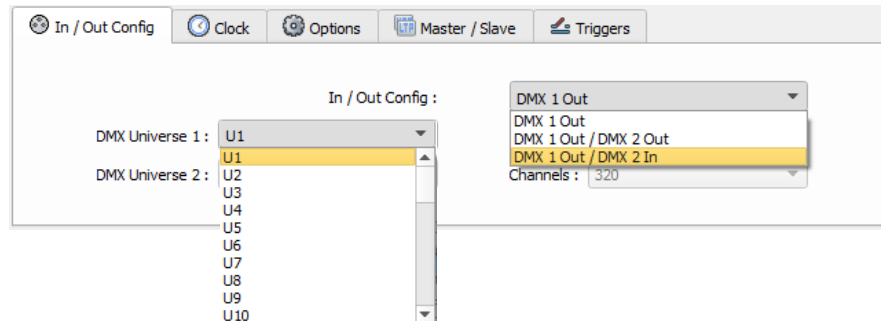

The Stand Alone mode offers up to 512 DMX IN channel triggers and up to 255 DMX trigger values per channel. By selecting a scene in the list, it's possible to choose the channel number and the DMX value to trigger the scene. The scene will play when the value of the DMX channel is reached or exceeded.

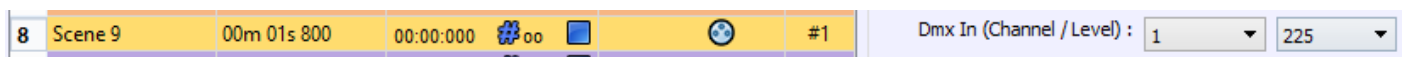

SETUP DMX IN MODE IN SOFTWARE USE

In software one DMX Output must be turned into an input in the Options windows. To access this window click on the software menu: Tools > Options then click to select the device section as following:

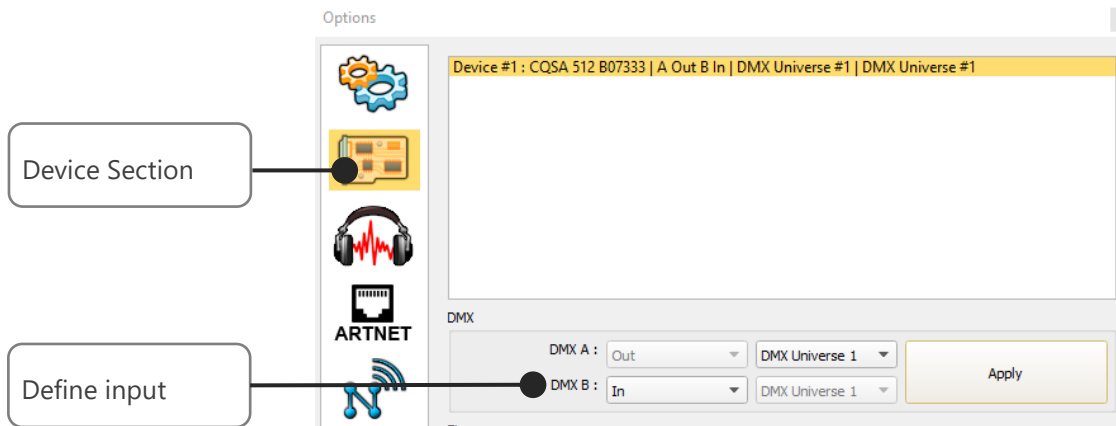

You can select an universe for output and input mode with 1024 and 512 interfaces.

Follow those steps to set a DMX-IN trigger on a scene or on a program:

Step 1: Go to the scenes list in the editor view.

Step 2: Double click the "Key" cell of the scene to be triggered.

Name	Cross fade time	Loops	Jump	Duration	Key	Live
Scene 1	00m 00s 000	Always loop	Stop	00m 01s 000	[...]	<input checked="" type="checkbox"/>
Scene 2	00m 00s 000	1 Loops	Stop	00m 01s 000	[...]	<input checked="" type="checkbox"/>
Scene 3	00m 00s 000	Always loop	Stop	00m 01s 000	[...]	<input checked="" type="checkbox"/>
Scene 4	00m 01s 800				[...]	<input checked="" type="checkbox"/>

Triggers

Shortcut:

MIDI

No MIDI trigger Channel:

MIDI Note Value:

MIDI Ctrl Change Min: Max:

MIDI Prog Change

DMX

No DMX trigger DMX Universe:

DMX Level Channel:

DMX Scale Value: Min: Max:

SA Triggers

Buttons:

Remote:

External Contacts: 01

Auto release On / Off

Step 3: Go to the DMX section of the Key window.

Two DMX-IN trigger options are available: DMX Level and DMX Scale, let's see what the differences are:

Option DMX Level

DMX

No DMX trigger

DMX Level

DMX Scale

DMX Universe : DMX Universe 1

Channel : 1

Value : 127

Min :

Max :

Choose the input universe and channel

Choose the trigger level with one if you go over it the scene starts and under it the scene stops.

Option DMX Scale

DMX

No DMX trigger

DMX Level

DMX Scale

DMX Universe : DMX Universe 1

Channel : 1

Value :

Min : 80

Max : 150

Choose the input universe and channel

Choose the trigger range of levels. With one if you go inside it the scene starts and outside it, the scene stops.

With the DMX Scale you can create many triggers presets on a same DMX-IN channel and so starts a suite of scenes on the DMX fader way.

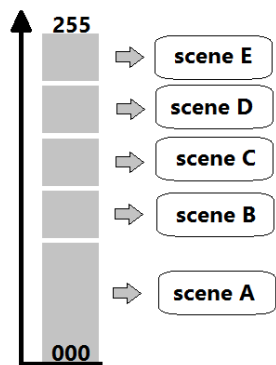

TIME TRIGGERS WITH CLOCK AND CALENDAR

The Stand Alone mode has an internal clock and a calendar. It's possible to assign a time trigger on every scene of the list. By selecting a scene on the list, it's possible to choose the start and end dates and hours and days of the week. You can thus create a lot of scenarios.

CASE 1: Programming an unique trigger:

- **Start schedule:**

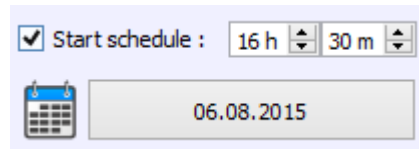

The scene is triggered a single time at the given date and time.

- **End schedule:**

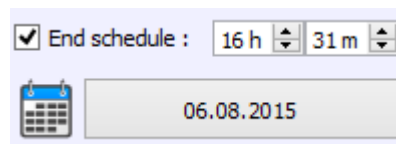

The scene is stopped at the given date and time.

CASE 2: Programming a repeating trigger:

- **Start schedule:**

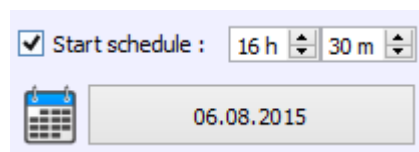

Date from which-one the scene will be playable according to the programmed triggers

- **End schedule:**

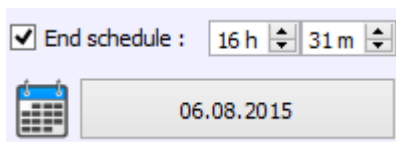

Date after witch-one triggers will be ignored. With no End date, triggers are permanent

- **List of the months of the year**

A horizontal row of 12 checkboxes, each followed by a month abbreviation: J, F, M, A, M, J, J, A, S, O, N, D. The checkboxes for J, M, M, J, A, S, N are checked, while F, A, J, J, O, D are unchecked.

The 12 check boxes represents the 12 months of the year (J) January to (D) December. The triggers will be performed on the activated months. Next, a daily hours range must be defined.

- **Start and Stop days**

Two dropdown menus. The first is labeled 'Day Start : 01' and the second is labeled 'Day Stop : 15'.

With a monthly repetition, you can choose the starting and stopping days for each chosen month. In this example triggers can happen between the 1st and the 15th of each chosen month.

- **List of the days of the week**

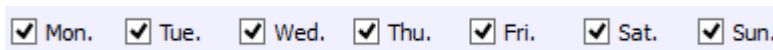
A horizontal row of 7 checkboxes, each followed by a day abbreviation: Mon., Tue., Wed., Thu., Fri., Sat., Sun. All checkboxes are checked.

The 7 check boxes represents the 7 days in a week. The triggers will be performed on the activated days only. Next, a time range must be defined.

- **Start time**

A label 'Start Time :' followed by two spinners. The first spinner is set to '11 h' and the second is set to '30 m'.

The starting time is the time when the scene will be triggered for each chosen day. Of course chosen months, start and end schedule days are included.

- **Release time**

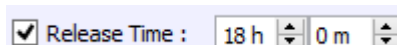
A label 'Release Time :' with a checked checkbox, followed by two spinners. The first spinner is set to '18 h' and the second is set to '0 m'.

The release time is the time when the scene will stop for each chosen day. Of course chosen months, start and end schedule days are included. The release time is not mandatory, if it's not defined, the scene will keep playing until another trigger event happens. (Like the triggering of another scene for example).

NOTE: For a daily repetition, if the the starting time is later than the release time then the triggering will stopped the next day, even if the next day has not been selected.

SAVE AND RECOVER THE LAST SCENE AFTER THE POWER CUT OFF:

The interface can save the last scene played before the power cut off and recover it when the power is restored.

For each scene you can select "Restore if power off"

Scenes to load in memory			
Name	Duration	Properties	Triggers
1 Scene 1	00m 04s 000	00:00:00 # oo <input type="checkbox"/>	①
2 Scene 2	00m 01s 800	00:00:00 # oo <input type="checkbox"/>	②
3 Scene 3	00m 06s 120	00:00:00 # oo <input type="checkbox"/>	③
4 Scene 4	00m 01s 000	00:00:00 # oo <input type="checkbox"/>	④

Remote :

External Contacts :
01 - A / T1 On

Dmx In (Channel / Level) :

RS232 :

Restore if power off

Click for enable the Restoration option

SCENE TRIGGER PRIORITIES:

When several scenes have the same time trigger (date + hour + minute), only the first scene in the list will be triggered. The rest will be ignored

DMX MERGING IN STANDALONE

One DMX line must be turned into an input to capture the dmx signal provided by an external DMX board or by another DMX interface.

The interface will merge the incoming signal with its own output signal by comparing the DMX levels with a HTP filter (priority on the highest levels of the signals). Merging is a solution to keep manual control on channels, using a DMX Board for example. It's also a way to create a multi-zones system by merging several interfaces on one final DMX line. In this last case, each interface can play a scene dedicated to the fixtures at the same time and on the same DMX line.

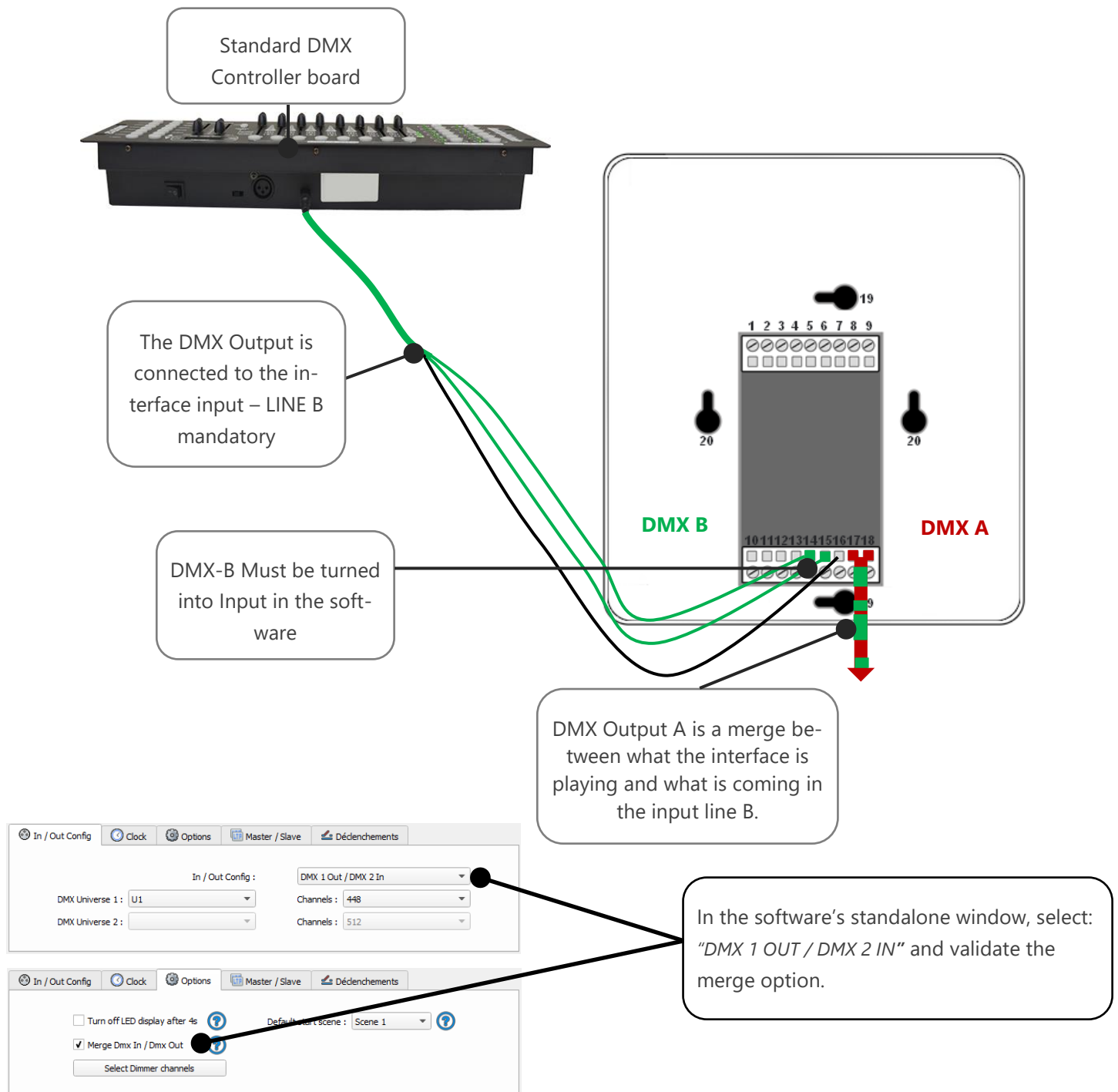

CONFIGURATION OF THE MASTER/SLAVE INTERFACES

When multiple interfaces are connected with USB, the standalone mode allows to set them as Master/Slave. This mode allows to synchronise many interfaces and mutualize their standalone spaces combining the universes. (up to 32 standalone universes)

Here are two example of wiring with 3 interfaces connected in Master/Slave :

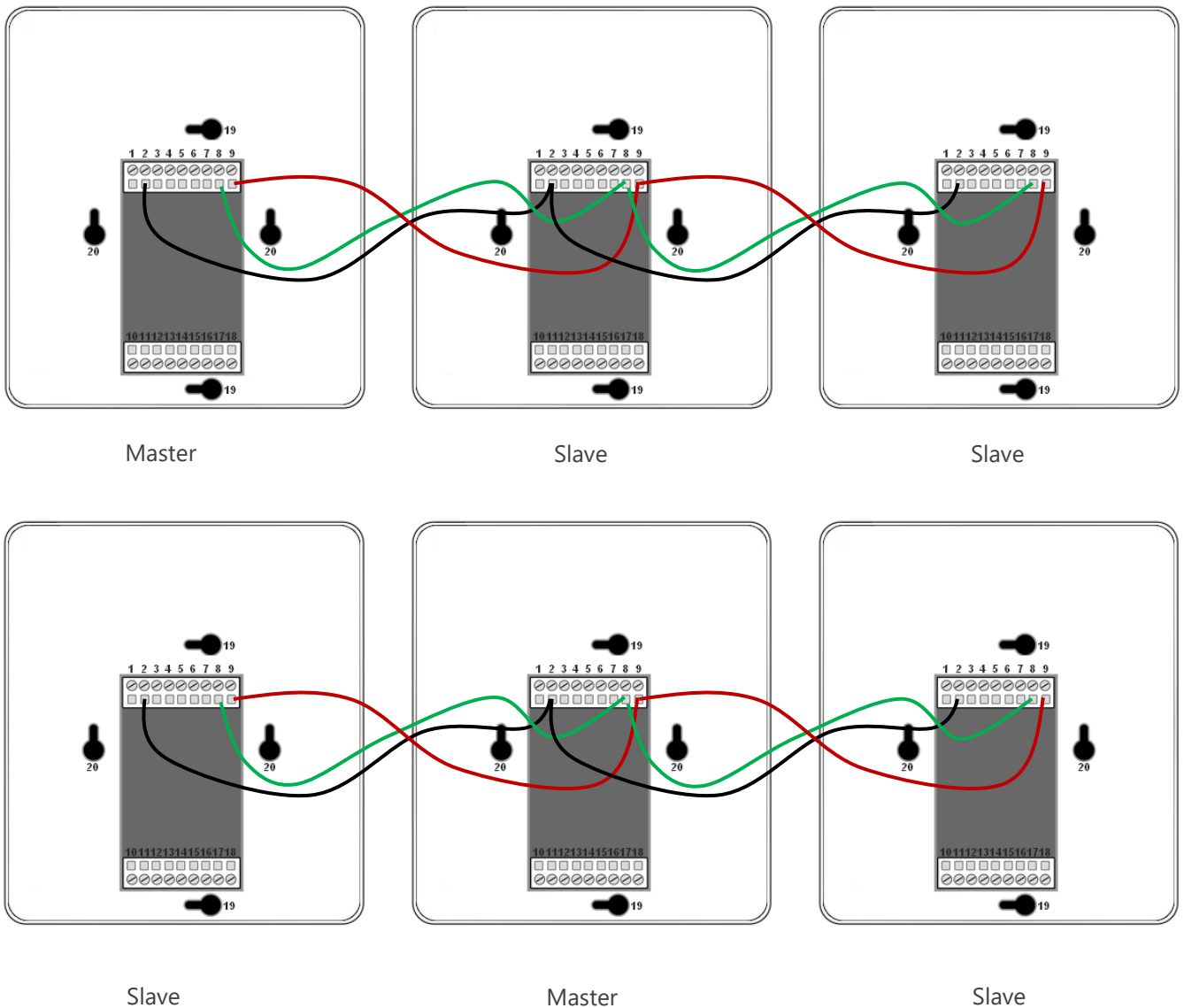
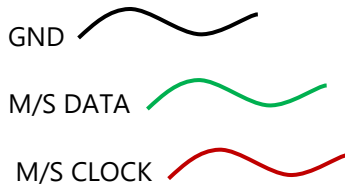

SETTING OF THE MASTER/SLAVE INTERFACES

A single interface can be define as master, others are automatically set to slaves. Triggers operated on the master interface are passed on slaves. However slaves are not synchronized on play time and keep individual control. Consequently slaves can trig and play different scenes. The master acts like a general remote imposing triggering to the slaves.

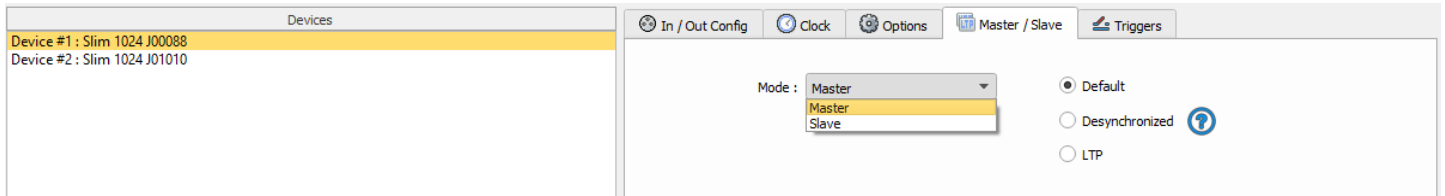

- **MODE MASTER/SLAVE « Default »**

A single interface can be define as master (lower serial number by default), others ones are automatically set to slaves. The master device play the current scene and synchronize the slave ones. The master forces the slave interfaces to play the same scene and the same step at the same time. The slave interfaces are forced to follow the master timings and triggers and they cannot act, play or trigger a scene independently. Master can trigger on and trigger off scenes of the slave interfaces.

- **MODE MASTER/SLAVE « Desynchronized»**

An interface can be define as master, others are automatically set to slaves. All Triggers On or Off operated on the master interface are effective to slave ones. However slave interfaces are not synchronized with master's timing and keep individual controls. Consequently slaves can trigger and play different scenes at any time and not synchronized with the master ones. The master acts like a general remote imposing triggering to the slaves with total priority. Master can trigger ON and trigger OFF scenes of the slave interface.

- **MODE MASTER/SLAVE « LTP »**

LTP means Latest Takes Priority. All interfaces are defined as slaves. Interfaces are not synchronized with timing and can trigger and play different scenes by itself. However triggers from an interface are passed to the others connected interfaces automatically and slave interfaces are forced to trigger the same scene. Here each interface acts like a general remote imposing triggering to the other slaves without synchronization.

- **THE «NO RELEASE» Option**

This option is only available with LTP or DESYNCHRONIZED modes. Only triggers ON from the master interface are executed and effective. All triggers OFF are ignored and slaves interfaces keep playing their current scene. Each Slave interface can choose to release or not its scene depend on the option is activated or not.

SD CARD

It is possible to save your show on micro SD card. The Card must be format as FAT 32 and 16 Gb Maximum.

In standalone mode, click to "Save on SD card", select a place to save the show on the computer or directly at the micro Sd card root.

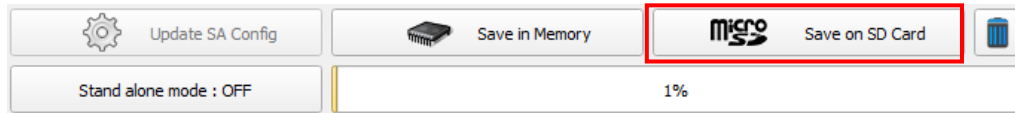

To play in standalone the SD show, insert the card into the CQSA micro SD slot and when the card is booted, the display will show "Sd" to indicate that the SD show is playing.

The show file must be paste to the micro SD root, it can not be played if it is renamed.

BATTERY

The battery allow to keep the clock and calendar settings in memory when the device is not powered.

The clock can keep the time and date up to 10 to 30 days, depending on the charging time and the type of battery included.

The device must be powered few hours to fully charge the battery.

WALL MOUNTING INSTRUCTIONS

The SLIM interface can we wall mounted on any place and surface.

Wires are connected to the screw terminal block located on back of the SLIM housing. To fix the SLIM housing to a Europe, Asia or America standard wall switch box, there are 4 holes located behind the housing.

Follow the mounting instruction to proceed.

FOR EUROPE AND ASIA STANDARD: 60MM CENTER TO CENTER DISTANCE.

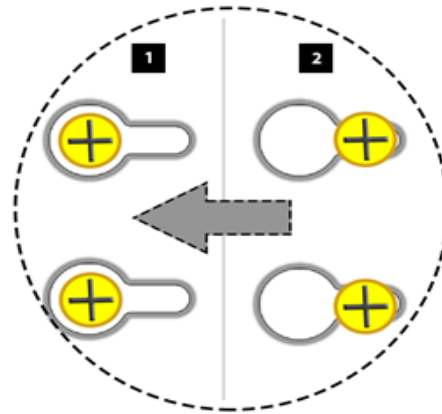
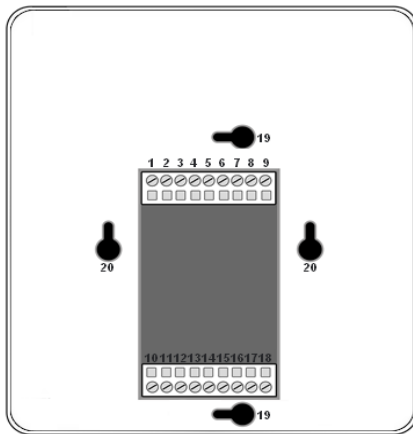

- 1** Insert the screws in the hole (vertical axe for USA wall boxes else horizontal axe) , adjust the screw position to hold well the housing.
- 2** Slide the housing to lock the screw in the slots

FOR AMERICA STANDARD: 84MM CENTER TO CENTER DISTANCE.

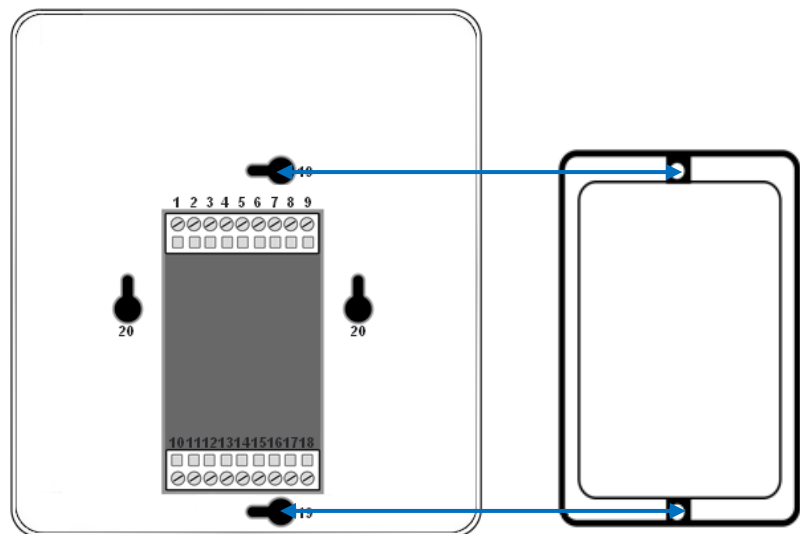

Use the screws of the wall switch box to old the SLIM

DIMENSIONS OF THE INTERFACE

The metric system is used. The unit is mm.

BOTTOM FACE

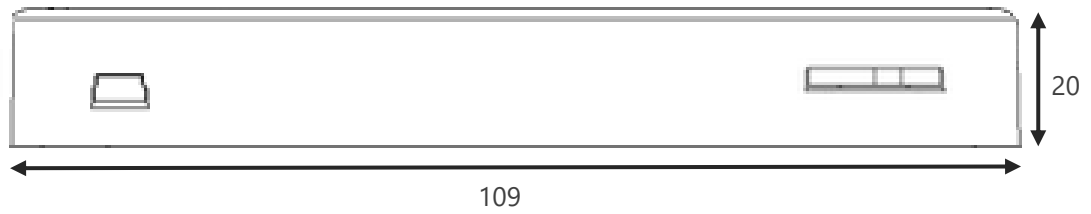

SIDE FACES

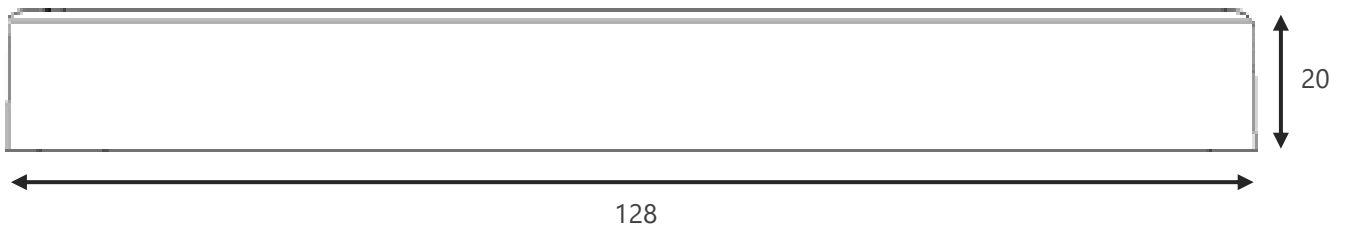

BACK FACE

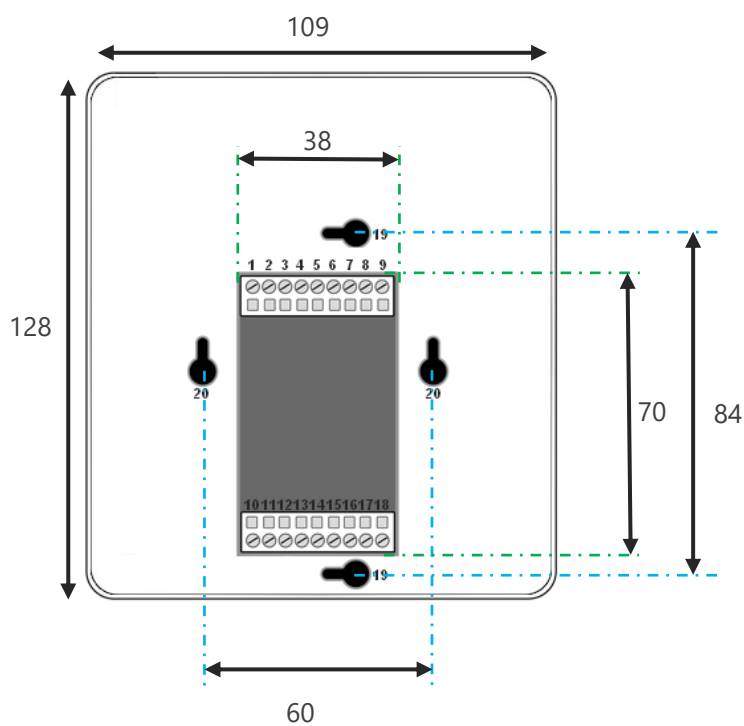

Example of Multiple interface connections

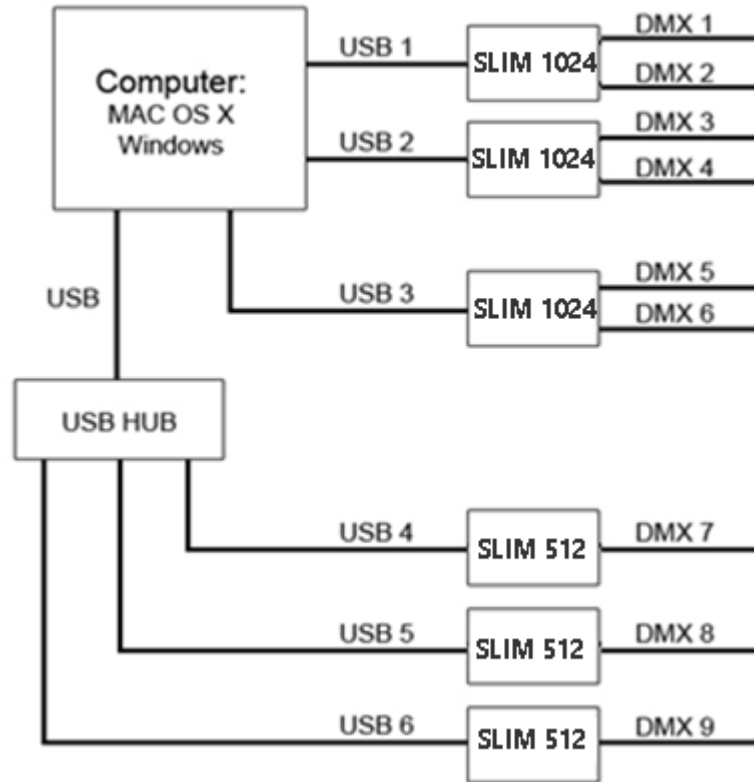

STANDARD DMX 512 INSTALLATION

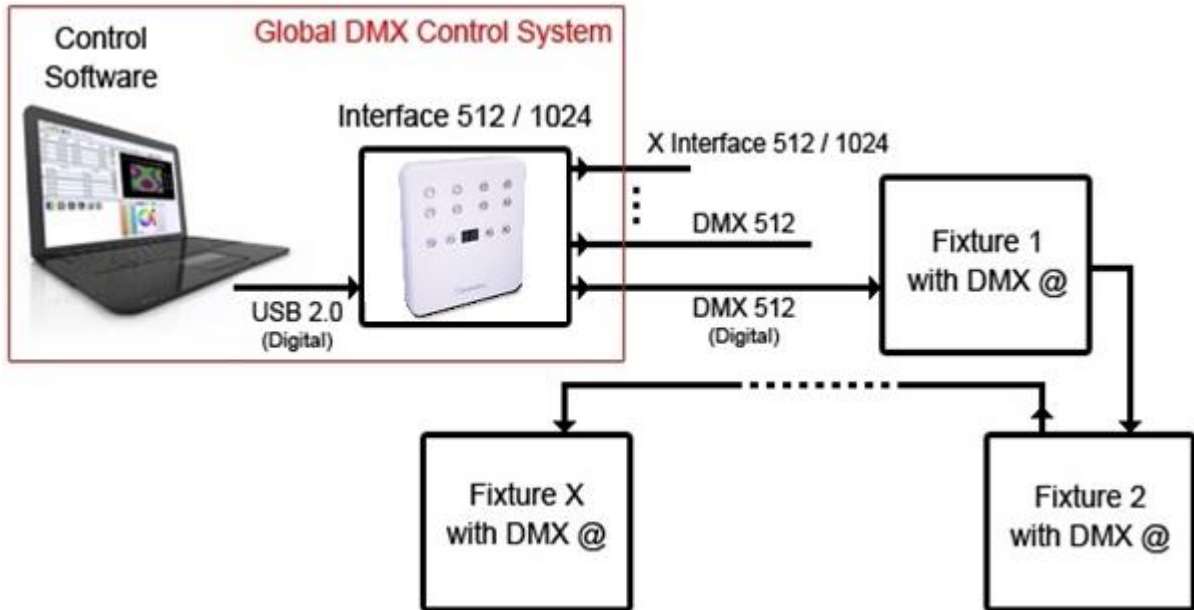

RECOMMENDED DMX512 INSTALLATION

