



Product designation	Power contactor		
Product type designation	BFK150		
<b>Contact characteristics</b>			
Number of poles	Nr.	3	
Rated insulation voltage $U_i$ IEC/EN	V	690	
Rated impulse withstand voltage $U_{imp}$	kV	8	
Operational frequency	min	Hz	25
	max	Hz	400
IEC Conventional free air thermal current $I_{th}$	A	165	
Rated operational power AC-6b ( $T \leq 40^\circ C$ )	230V	kvar	50
	400V	kvar	100
	440...480V	kvar	115
	690V	kvar	150
Short-time allowable current for 10s (IEC/EN60947-1)	A	1200	
Protection fuse	gG (IEC)	A	160
		A	1500
Making capacity (RMS value)		A	1500
Breaking capacity at voltage	440V	A	1200
	500V	A	1025
	690V	A	905
		m $\Omega$	0.45
Resistance per pole (average value)		m $\Omega$	0.45
Power dissipation per pole (average value)	lth	W	12
Tightening torque for terminals	min	Nm	6
	max	Nm	7
	min	lbin	4.4
	max	lbin	5.2
Tightening torque for coil terminal	min	Nm	0.8
	max	Nm	1
	min	lbin	0.59
	max	lbin	0.74
Max number of wires simultaneously connectable	Nr.	2	
Conductor section	AWG/Kcmil	max	2/0
	Flexible w/o lug conductor section	min	mm <sup>2</sup> 1.5
max		mm <sup>2</sup> 70	
Flexible c/w lug conductor section	min	mm <sup>2</sup>	1.5

		max	mm <sup>2</sup>	70
Power terminal protection according to IEC/EN 60529				IP20 front
<b>Mechanical features</b>				
Operating position		normal allowable		Vertical plan ±30°
Fixing				Screw / DIN rail 35mm
Weight			g	2095
Conductor section	AWG/kcmil conductor section	max		2/0
<b>Operations</b>				
Mechanical life			cycles	15000000
Electrical life			cycles	800000
<b>Safety related data</b>				
Performance level B10d according to EN/ISO 13489-1		rated load mechanical load	cycles cycles	400000 15000000
EMC compatibility				yes
<b>AC coil operating</b>				
Rated AC voltage at 60Hz			V	230
AC operating voltage	of 60Hz coil powered at 60Hz			
	pick-up	min	%Us	80
		max	%Us	110
	drop-out	min	%Us	20
		max	%Us	55
AC average coil consumption at 20°C	of 60Hz coil powered at 60Hz	in-rush holding	VA VA	300 20
Dissipation at holding ≤20°C 50Hz			W	6.5
<b>Max cycles frequency</b>				
Mechanical operation			cycles/h	1500
<b>Operating times</b>				
Average time for Us control	in AC			
	Closing NO	min	ms	16
		max	ms	32
	Opening NO	min	ms	9
		max	ms	24
<b>UL technical data</b>				
General USE	Contactor	AC current	A	165
<b>Ambient conditions</b>				
Temperature	Operating temperature			

min	°C	-50
max	°C	70

Storage temperature

min	°C	-60
max	°C	80
	m	3000

Max altitude

**Resistance & Protection**

Pollution degree

3

**Dimensions**

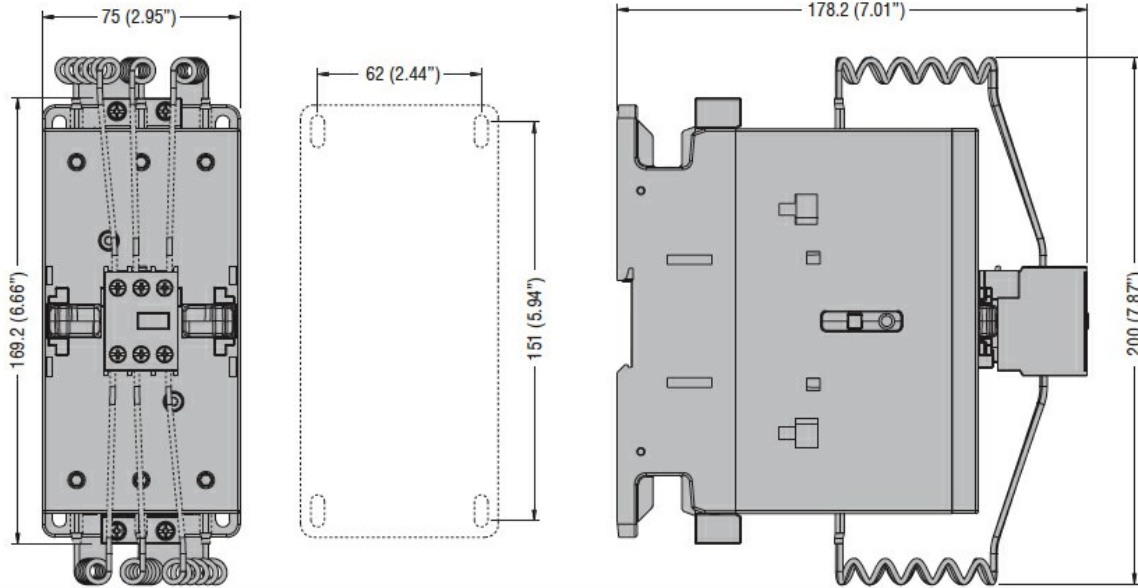

**Wiring diagrams**

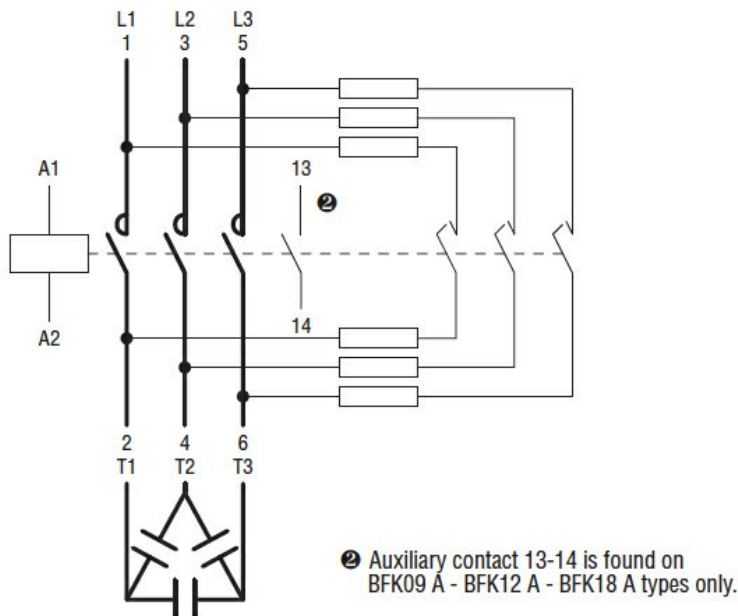

**Certifications and compliance**

Compliance

CSA C22.2 n° 60947-1

CSA C22.2 n° 60947-4-1

IEC/EN/BS 60947-1

IEC/EN/BS 60947-4-1

UL 60947-1

UL 60947-4-1

---

Certificates

CCC

---

cULus

ETIM classification

ETIM 8.0

EC001079 -  
Capacitor  
contactor