



CLV620-1831S01

CLV62x

FIXED MOUNT BARCODE SCANNERS

SICK
Sensor Intelligence.



Illustration may differ

Ordering information

Type	Part no.
CLV620-1831S01	1067933

In order to achieve enclosure rating IP69K, please use only connection cables prescribed by SICK (see "Recommended accessories").

Other models and accessories → www.sick.com/CLV62x



Detailed technical data

Features

Version	Mid Range
Connection type	Ethernet
Reading field	Front
Sensor type	Raster scanner
Optical focus	Fixed focus
Light source	Light spot, laser, Visible, Red, 655 nm
Laser class	2 (IEC 60825-1:2014, EN 60825-1:2014)
Aperture angle	≤ 50°
Reading distance	63 mm ... 347 mm ¹⁾
Scanning frequency	400 Hz ... 1,200 Hz
Code resolution	0.2 mm ... 1 mm
Raster height, number of lines, at distance	15 mm, 8, 200 mm

¹⁾ For details see reading field diagram.

Mechanics/electronics

Connection type	2 x M12 cylindrical connectors (1 x 17-pin male connector, 4-pin female connector)
Supply voltage	10 V DC ... 30 V DC
Power consumption	4.5 W
Housing	Stainless steel
Housing color	Stainless steel (unpainted)
Window material	Plastic
Enclosure rating	IP69K (DIN 40 050, part 9)
Protection class	III (VDE 0106/IEC 1010-1)
Weight	+ 854 g, without connecting cable

¹⁾ At 25 °C.

Dimensions (L x W x H)	85 mm x 154 mm x 84 mm
MTBF	100,000 h
MTTF	40,000 h (Laser diode) ¹⁾

¹⁾ At 25 °C.

Performance

Readable code structures	1D codes
Bar code types	All current code types
Code printing process	Label (printed codes)
Print ratio	2:1 ... 3:1
No. of codes per scan	1 ... 20 (Standard decoder) 1 ... 6 (SMART620)
No. of codes per reading interval	1 ... 50 (auto-discriminating)
No. of characters per reading interval	1,500 500 (for multiplexer function in CAN operation)
No. of multiple readings	1 ... 99

Interfaces

Ethernet	✓, TCP/IP, RS-232, RS-422, RS-485
Type of fieldbus integration	Optional over external fieldbus module CDF600 Optional over external fieldbus module CDF600-2
Function	Data interface (read result output), Service interface PROFINET Single Port, PROFINET Dual Port (optional via external connection module CDF600-2) Data interface (read result output), Service interface SICK CAN sensor network CSN (CAN controller/CAN device, multiplexer/server)
Data transmission rate	10/100 MBit/s 10/100 MBit/s 10/100 MBit/s 2,400 Baud ... 115.2 kBaud, AUX: 57.6 kBaud (RS-232) 20 kbit/s ... 1 Mbit/s 20 kbit/s ... 1 Mbit/s
Digital inputs	4 ("Sensor 1", "Sensor 2", 2 inputs via optional CMC600 in CDB650)
Digital outputs	4 ("Result 1", "Result 2", 2 via optional CMC600 parameter memory in CDB650)
Reading pulse	Digital inputs
Configuration software	SOPAS ET

Ambient data

Electromagnetic compatibility (EMC)	EN 61000-6-3 (2001-10) / EN 61000-6-2:2005
Vibration resistance	EN 60068-2-6 (1995)
Shock resistance	EN 60068-2-27 (1993)
Ambient operating temperature	0 °C ... +40 °C
Storage temperature	-20 °C ... +70 °C
Permissible relative humidity	90 %, Non-condensing
Ambient light immunity	2,000 lx, on barcode
Bar code print contrast (PCS)	≥ 60 %

Classifications

ECLASS 5.0	27280102
-------------------	----------

ECLASS 5.1.4	27280102
ECLASS 6.0	27280102
ECLASS 6.2	27280102
ECLASS 7.0	27280102
ECLASS 8.0	27280102
ECLASS 8.1	27280102
ECLASS 9.0	27280102
ECLASS 10.0	27280102
ECLASS 11.0	27280102
ECLASS 12.0	27280102
ETIM 5.0	EC002550
ETIM 6.0	EC002550
ETIM 7.0	EC002550
ETIM 8.0	EC002550
UNSPSC 16.0901	43211701

Dimensional drawing (Dimensions in mm (inch))

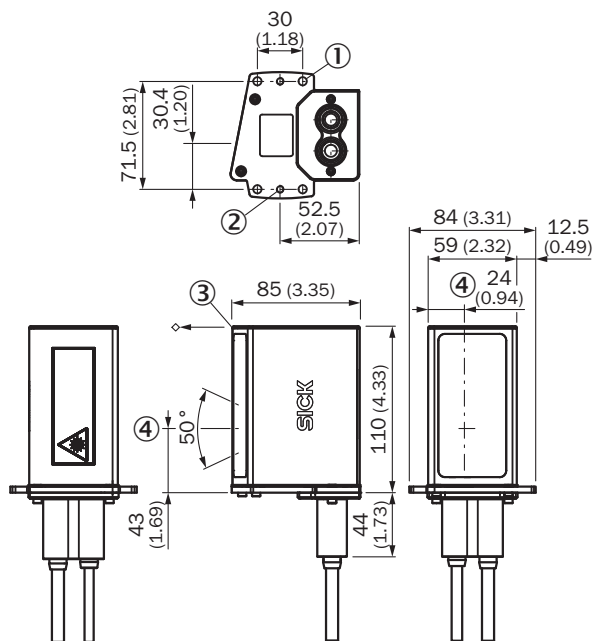

- ① Mounting holes, \varnothing 5.5 mm (4 x)
- ② Threaded holes, M5 (2 x)
- ③ Reference point for reading distance (from housing edge to object)
- ④ Position light emission

Reading field diagram

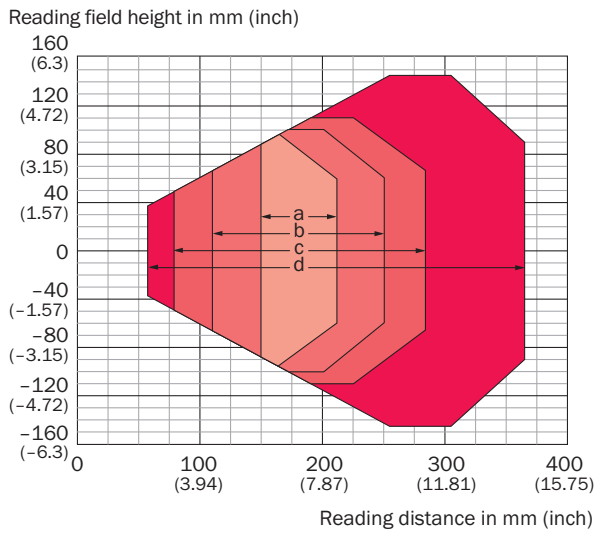





For devices with plastic reading window, the depth of field is reduced by approx. 10 %.

Resolution

- a: 0.2 mm (7.9 mil)
- b: 0.35 mm (13.8 mil)
- c: 0.50 mm (19.7 mil)
- d: 1.00 mm (39.4 mil)

Recommended accessories

Other models and accessories → www.sick.com/CLV62x

	Brief description	Type	Part no.
Cloning modules			
	External parameter memory for integration in CDB620/CDB650/CDM42x	CMC600-101	1042259
Mounting brackets and plates			
	Bracket	Mounting bracket	2068600
Plug connectors and cables			
	<ul style="list-style-type: none"> • Connection type head A: Male connector, M12, 4-pin, straight, D-coded • Connection type head B: Male connector, RJ45, 8-pin, straight • Signal type: Ethernet • Cable: 2 m, 4-wire, AWG26 • Description: Ethernet, shielded 	YM2D24-020EB2MRJA4	6050198
	<ul style="list-style-type: none"> • Connection type head A: Female connector, M12, 17-pin, straight, A-coded • Connection type head B: Male connector, M12, 17-pin, straight, A-coded • Signal type: Power, serial, CAN, digital I/Os • Cable: 3 m, 17-wire • Description: Power, serial, CAN, digital I/Os, suitable for 2 A, shielded, to connection module CDB650 • Application: Drag chain operation 	YM2A8D-030XXXF2A8D	6051194

	Brief description	Type	Part no.
Modules			
	<ul style="list-style-type: none"> • Sub product family: CDB650 • Supported products: Lector® series, CLV62x - CLV64x (depending on type), CLV69x, RFID read/write device, InspectorP series • Brief description: Connection device basic for connecting one sensor with 2 A fuse, 5 cable glands and RS-232 interface to sensor via M12, 17-pin female connector, all outputs available on screw/spring-loaded terminals. 	CDB650-204	1064114

Recommended services

Additional services → www.sick.com/CLV62x

	Type	Part no.
Performance check		
<ul style="list-style-type: none"> • Product area: Fixed mount barcode scanners • Range of services: Inspection of defined functions, e.g., reading performance • Travel expenses: The prices do not include travel costs such as hotel, flight, travel time and expenses. • Duration: Additional work will be invoiced separately 	Performance check CLV4xx/CLV6xx	1682028
Commissioning		
<ul style="list-style-type: none"> • Product area: Fixed mount barcode scanners • Range of services: Inspection of connection, fine adjustment, optimization of parameters of SICK product as well as tests, Setup of previously defined functions of reading configuration, code configuration, data processing and network, interfaces or inputs and outputs • Travel expenses: The prices do not include travel costs such as hotel, flight, travel time and expenses. • Duration: Additional work will be invoiced separately 	Commissioning CLV61x ... CLV64x	1681925
Extended warranty		
<ul style="list-style-type: none"> • Product area: Identification solutions, machine vision, Detection and ranging solutions, safety camera sensors, Safety laser scanners, Safety radar sensors • Range of services: The services correspond to the scope of the statutory manufacturer warranty (SICK general terms of delivery). • Duration: Five-year warranty from delivery date. 	Extended warranty for a total of five years from delivery date	1680671

SICK AT A GLANCE

SICK is one of the leading manufacturers of intelligent sensors and sensor solutions for industrial applications. A unique range of products and services creates the perfect basis for controlling processes securely and efficiently, protecting individuals from accidents and preventing damage to the environment.

We have extensive experience in a wide range of industries and understand their processes and requirements. With intelligent sensors, we can deliver exactly what our customers need. In application centers in Europe, Asia and North America, system solutions are tested and optimized in accordance with customer specifications. All this makes us a reliable supplier and development partner.

Comprehensive services complete our offering: SICK LifeTime Services provide support throughout the machine life cycle and ensure safety and productivity.

For us, that is “Sensor Intelligence.”

WORLDWIDE PRESENCE:

Contacts and other locations –www.sick.com