



VTF18-4P1712

V18

CYLINDRICAL PHOTOELECTRIC SENSORS

**SICK**  
Sensor Intelligence.



### Ordering information

Type	Part no.
VTF18-4P1712	6012901

Other models and accessories → [www.sick.com/V18](http://www.sick.com/V18)

Illustration may differ



### Detailed technical data

#### Features

<b>Functional principle</b>	Photoelectric proximity sensor
<b>Functional principle detail</b>	Background blanking
<b>Dimensions (W x H x D)</b>	18 mm x 18 mm x 63.6 mm
<b>Housing design (light emission)</b>	Cylindrical
<b>Housing length</b>	63.6 mm
<b>Thread diameter (housing)</b>	M18 x 1
<b>Optical axis</b>	Axial
<b>Sensing range max.</b>	3 mm ... 100 mm <sup>1)</sup>
<b>Sensing range</b>	3 mm ... 90 mm
<b>Type of light</b>	Infrared light
<b>Light source</b>	LED <sup>2)</sup>
<b>Light spot size (distance)</b>	Ø 3 mm (50 mm)
<b>Adjustment</b>	Potentiometer, 270° (Sensing range)
<b>Special feature</b>	Focused optics

<sup>1)</sup> Object with 90% remission (based on standard white, DIN 5033).

<sup>2)</sup> Average service life: 100,000 h at T<sub>J</sub> = +25 °C.

## Mechanics/electronics

<b>Supply voltage <math>U_B</math></b>	10 V DC ... 30 V DC <sup>1)</sup>
<b>Ripple</b>	$\pm 10\%$ <sup>2)</sup>
<b>Current consumption</b>	30 mA <sup>3)</sup>
<b>Switching output</b>	PNP <sup>4)</sup>
<b>Switching mode</b>	Light/dark switching <sup>4)</sup>
<b>Switching mode selector</b>	Selectable via L/D control cable
<b>Output current <math>I_{max}</math></b>	$\leq 100$ mA
<b>Response time</b>	$\leq 2$ ms <sup>5)</sup>
<b>Switching frequency</b>	250 Hz <sup>6)</sup>
<b>Connection type</b>	Cable, 4-wire, 2 m <sup>7)</sup>
<b>Cable material</b>	PVC
<b>Conductor cross section</b>	0.14 mm <sup>2</sup>
<b>Cable diameter</b>	$\varnothing 5$ mm
<b>Circuit protection</b>	A <sup>8)</sup> B <sup>9)</sup> C <sup>10)</sup> D <sup>11)</sup>
<b>Protection class</b>	III
<b>Weight</b>	100 g
<b>Housing material</b>	Plastic, PBT/PC
<b>Optics material</b>	Plastic, PMMA
<b>Enclosure rating</b>	IP67
<b>Special feature</b>	Focused optics
<b>Ambient operating temperature</b>	-25 °C ... +70 °C
<b>UL File No.</b>	NMFT2.E175606

<sup>1)</sup> Limit values.

<sup>2)</sup> May not exceed or fall below  $U_V$  tolerances.

<sup>3)</sup> Without load.

<sup>4)</sup> Control wire open: dark switching D.ON.

<sup>5)</sup> Signal transit time with resistive load.

<sup>6)</sup> With light/dark ratio 1:1.

<sup>7)</sup> Do not bend below 0 °C.

<sup>8)</sup> A =  $V_S$  connections reverse-polarity protected.

<sup>9)</sup> B = inputs and output reverse-polarity protected.

<sup>10)</sup> C = interference suppression.

<sup>11)</sup> D = outputs overcurrent and short-circuit protected.

## Classifications

<b>eCl@ss 5.0</b>	27270904
<b>eCl@ss 5.1.4</b>	27270904
<b>eCl@ss 6.0</b>	27270904
<b>eCl@ss 6.2</b>	27270904
<b>eCl@ss 7.0</b>	27270904

<b>eCl@ss 8.0</b>	27270904
<b>eCl@ss 8.1</b>	27270904
<b>eCl@ss 9.0</b>	27270904
<b>eCl@ss 10.0</b>	27270904
<b>eCl@ss 11.0</b>	27270904
<b>eCl@ss 12.0</b>	27270903
<b>ETIM 5.0</b>	EC002719
<b>ETIM 6.0</b>	EC002719
<b>ETIM 7.0</b>	EC002719
<b>ETIM 8.0</b>	EC002719
<b>UNSPSC 16.0901</b>	39121528

### Adjustments

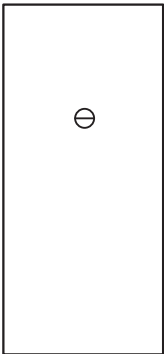

### Connection type



### Connection diagram

Cd-089

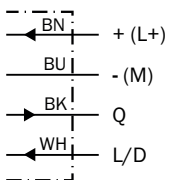

Characteristic curve

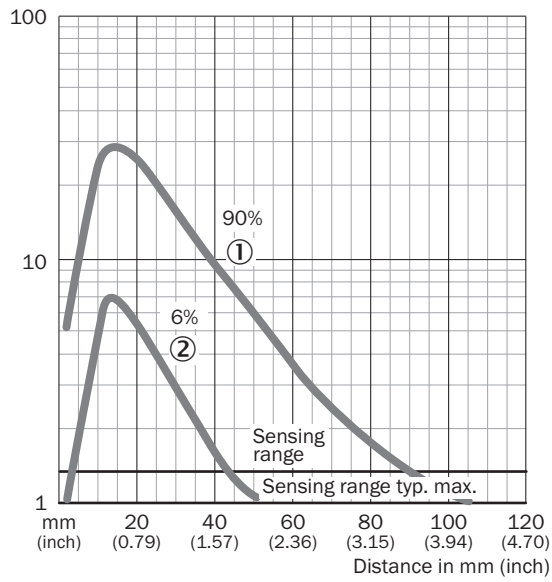

Sensing range diagram

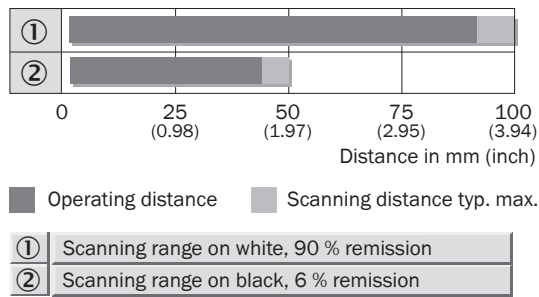

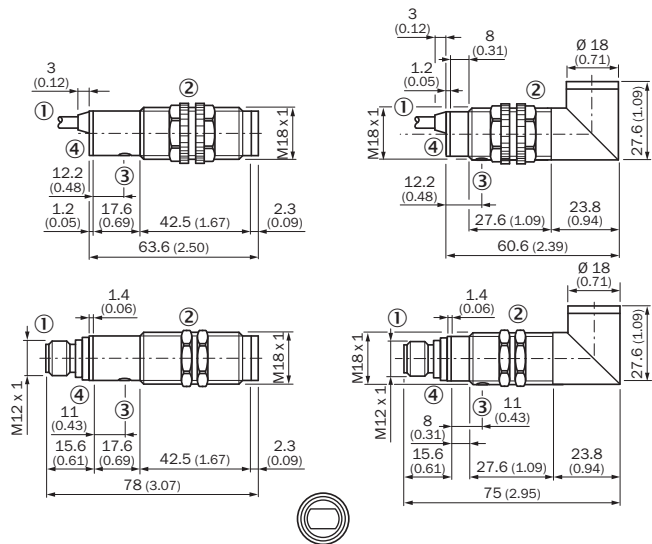

### Dimensional drawing (Dimensions in mm (inch))



- ① Connecting cable or connector
- ② Fastening nut, 22 mm hex, made of plastic for equipment with plastic housing  
Fastening nut, 24 mm hex, made of metal for equipment with metal housing
- ③ Sensitivity control
- ④ Signal strength indicator, LED, yellow

### Recommended accessories

Other models and accessories → [www.sick.com/V18](http://www.sick.com/V18)

	Brief description	Type	Part no.
<b>Mounting brackets and plates</b>			
	Mounting bracket for M18 sensors, steel, zinc coated, without mounting hardware	BEF-WN-M18	5308446
<b>Plug connectors and cables</b>			
	Head A: male connector, M12, 4-pin, straight Cable: unshielded	STE-1204-G	6009932

## SICK AT A GLANCE

SICK is one of the leading manufacturers of intelligent sensors and sensor solutions for industrial applications. A unique range of products and services creates the perfect basis for controlling processes securely and efficiently, protecting individuals from accidents and preventing damage to the environment.

We have extensive experience in a wide range of industries and understand their processes and requirements. With intelligent sensors, we can deliver exactly what our customers need. In application centers in Europe, Asia and North America, system solutions are tested and optimized in accordance with customer specifications. All this makes us a reliable supplier and development partner.

Comprehensive services complete our offering: SICK LifeTime Services provide support throughout the machine life cycle and ensure safety and productivity.

For us, that is “Sensor Intelligence.”

## WORLDWIDE PRESENCE:

Contacts and other locations –[www.sick.com](http://www.sick.com)