



AFM60A-BCNB018x12

AFS/AFM60 Ethernet

ABSOLUTE ENCODERS

SICK
Sensor Intelligence.

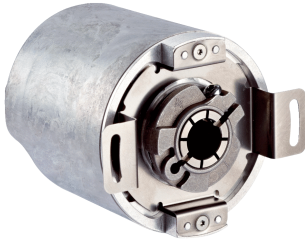

Illustration may differ



Ordering information

Type	Part no.
AFM60A-BCNB018x12	1059036

Other models and accessories → www.sick.com/AFS_AFM60_Ethernet

Detailed technical data

Performance

Number of steps per revolution (max. resolution)	262,144 (18 bit)
Number of revolutions	4,096 (12 bit)
Max. resolution (number of steps per revolution x number of revolutions)	18 bit x 12 bit (262,144 x 4,096)
Error limits G	0.03° ¹⁾
Repeatability standard deviation σ_r	0.002° ²⁾

¹⁾ In accordance with DIN ISO 1319-1, position of the upper and lower error limit depends on the installation situation, specified value refers to a symmetrical position, i.e. deviation in upper and lower direction is the same.

²⁾ In accordance with DIN ISO 55350-13; 68.3% of the measured values are inside the specified area.

Interfaces

Communication interface	PROFINET
Encoder profile	V4.1 class3
Data transmission rate (baud rate)	10 Mbit/s, 100 Mbit/s
Transmission medium	CAT-5e cable
Initialization time	6 s
Cycle time	≤ 1 ms
Parameterising data	Number of steps per revolution Number of revolutions PRESET Counting direction Sampling rate for speed calculation Unit for output of the speed value Round axis functionality
Available diagnostics data	Minimum and maximum temperature Maximum speed Power-on counter Operating hours counter power-on/motion Counter of direction changes/number of movements cw/number of movements ccw Maximum supply voltage

Electrical data

Connection type	Male connector, Female connector, 1x, 2x, M12, M12, 4-pin, 4-pin, axial, axial ^{1) 2)}
Supply voltage	10 ... 30 V
Power consumption	≤ 3 W (without load)
Reverse polarity protection	✓
MTTFd: mean time to dangerous failure	80 years (EN ISO 13849-1) ³⁾

¹⁾ A-coded.

²⁾ D-coded.

³⁾ This product is a standard product and does not constitute a safety component as defined in the Machinery Directive. Calculation based on nominal load of components, average ambient temperature 40 °C, frequency of use 8760 h/a. All electronic failures are considered hazardous. For more information, see document no. 8015532.

Mechanical data

Mechanical design	Blind hollow shaft
Shaft diameter	3/8"
Weight	0.2 kg
Shaft material	Stainless steel
Flange material	Aluminum
Housing material	Aluminum
Start up torque	0.8 Ncm (+20 °C)
Operating torque	0.6 Ncm (+20 °C)
Permissible movement static	± 0.3 mm (radial) ± 0.5 mm (axial)
Permissible movement dynamic	± 0.05 mm (radial) ± 0.1 mm (axial)
Operating speed	≤ 6,000 min ⁻¹ ¹⁾
Moment of inertia of the rotor	40 gcm ²
Bearing lifetime	3 x 10 ⁹ revolutions
Angular acceleration	≤ 500,000 rad/s ²

¹⁾ Allow for self-heating of 3.3 K per 1,000 rpm when designing the operating temperature range.

Ambient data

EMC	According to EN 61000-6-2 and EN 61000-6-3
Enclosure rating	IP65, shaft side (IEC 60529) IP67, housing side (IEC 60529) ¹⁾
Permissible relative humidity	90 % (Condensation not permitted)
Operating temperature range	-40 °C ... +85 °C
Storage temperature range	-40 °C ... +100 °C, without package
Resistance to shocks	100 g, 6 ms (EN 60068-2-27)
Resistance to vibration	30 g, 10 Hz ... 2,000 Hz (EN 60068-2-6)

¹⁾ With mating connector fitted.

Classifications

eCI@ss 5.0	27270502
eCI@ss 5.1.4	27270502

eCl@ss 6.0	27270590
eCl@ss 6.2	27270590
eCl@ss 7.0	27270502
eCl@ss 8.0	27270502
eCl@ss 8.1	27270502
eCl@ss 9.0	27270502
eCl@ss 10.0	27270502
eCl@ss 11.0	27270502
eCl@ss 12.0	27270502
ETIM 5.0	EC001486
ETIM 6.0	EC001486
ETIM 7.0	EC001486
ETIM 8.0	EC001486
UNSPSC 16.0901	41112113

Dimensional drawing (Dimensions in mm (inch))

Blind hollow shaft

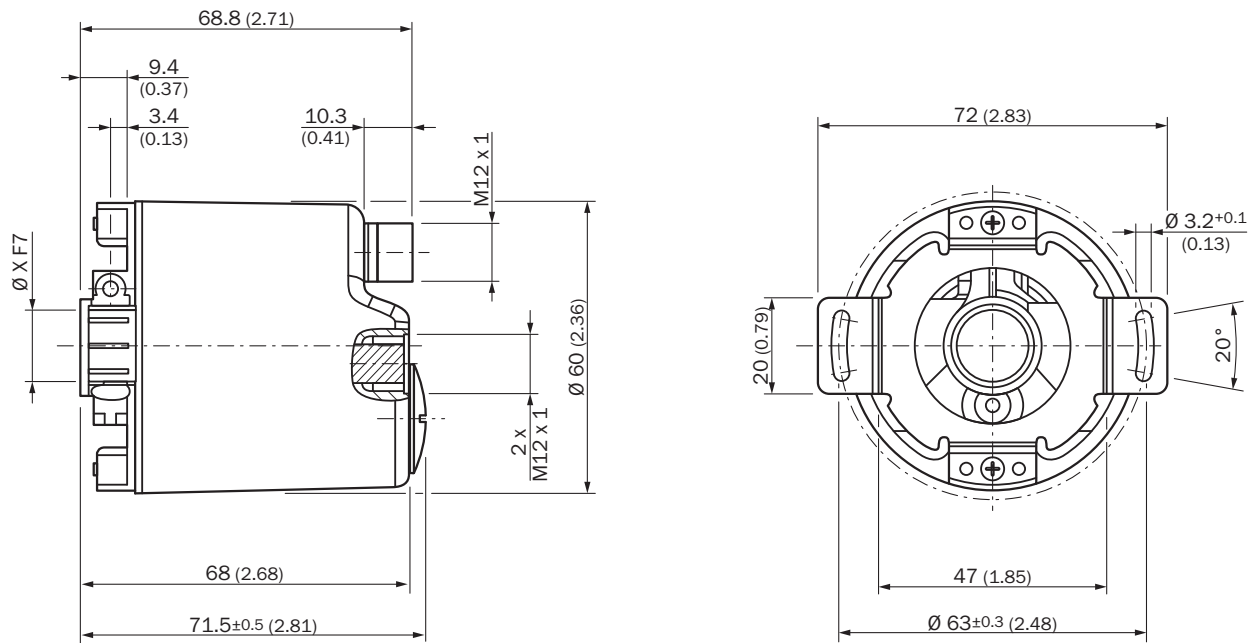

Diameter x f7 corresponds to the shaft diameter

Attachment specifications

Blind hollow shaft

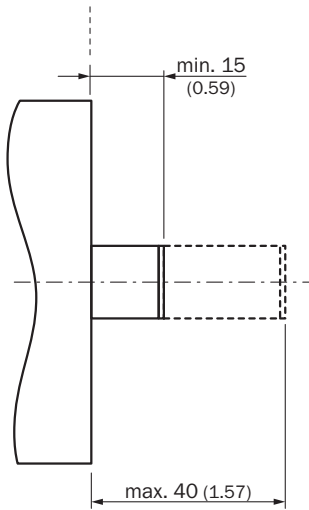

All dimensions in mm (inch)

PIN assignment

Male connector

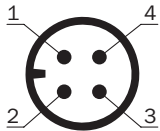

Supply voltage

PIN	Wire color	Signal
1	Brown	U _S 10 V ... 30 V
2	White	Not assigned
3	Blue	GND
4	Black	Not assigned

Female connector

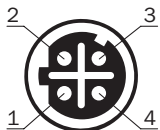

Port 1, Port 2





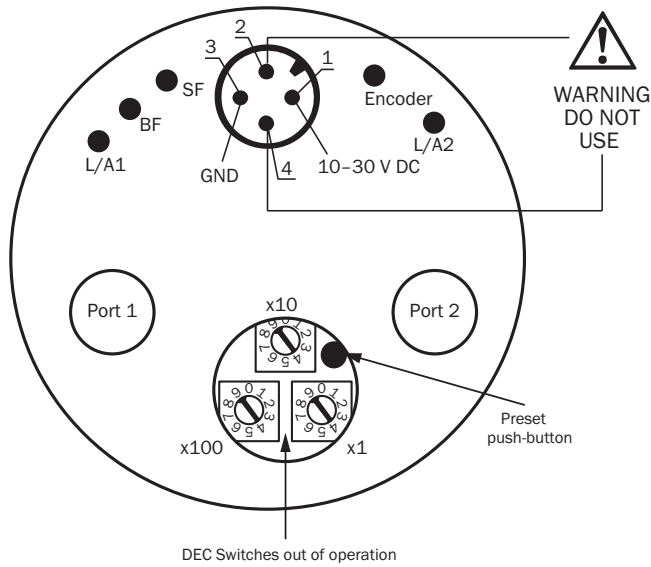

PIN	Wire color	Signal
1	Yellow	T x D+
2	White	R x D+
3	Orange	T x D-
4	Blue	R x D-







Connection diagram



Recommended accessories

Other models and accessories → www.sick.com/AFS_AFM60_Ethernet

	Brief description	Type	Part no.
Flanges			
	Standard stator coupling	BEF-DS00XFX	2056812
	One-sided stator coupling, slot, slot radius 33 mm to 211.9 mm, slot width 5.1 mm	BEF-DS03DFS/VFS	2047431
	Stator coupling with hole circle diameter Ø72 mm	BEF-DS07XFX	2059368
	Flange adapter, adaptation of face mount flange with 36 mm centering hub to 50 mm servo flange, aluminum, including 3 flat head screws M4 x 10, Aluminum, including 3 countersunk screws M3 x 10	BEF-FA-036-050	2029160
	Flange adapter, adaptation of face mount flange with 36 mm centering hub to 60 mm square mounting plate, aluminum, including 3 flat head screws M4 x 8, Aluminum, including 3 countersunk screws M4 x 8	BEF-FA-036-060REC	2029162
	Flange adapter, adaptation of face mount flange with 36 mm centering hub to 58 mm square mounting plate with shock absorbers, aluminum, Aluminum	BEF-FA-036-060RSA	2029163
	Flange adapter, adaptation of face mount flange with 36 mm centering hub to 63 mm square mounting plate, aluminum, including 3 flat head screws M4 x 10, Aluminum, including 3 countersunk screws M3 x 10	BEF-FA-036-063REC	2034225

	Brief description	Type	Part no.	
Other mounting accessories				
	Plastic measuring wheel with smooth plastic surface (Hytrel), for 10 mm solid shaft, circumference 200 mm	BEF-MR-010020	5312988	
	Measuring wheel with ridged plastic surface (Hytrel) for 10 mm solid shaft, circumference 200 mm	BEF-MR-010020G	5318678	
	Plastic measuring wheel with smooth plastic surface (Hytrel) for 10 mm solid shaft, circumference 500 mm	BEF-MR-010050	5312989	
	Aluminium measuring wheel with O-ring (NBR70) for 6 mm solid shaft, circumference 200 mm	BEF-MR006020R	2055222	
	Measuring wheel with O-ring (NBR70) for 6 mm solid shaft, circumference 300 mm	BEF-MR006030R	2055634	
	Aluminium measuring wheel with O-ring (NBR70) for 10 mm solid shaft, circumference 200 mm	BEF-MR010020R	2055224	
	Aluminium measuring wheel with O-ring (NBR70) for 10 mm solid shaft, circumference 300 mm	BEF-MR010030R	2049278	
	Measuring wheel with O-ring (NBR70) for 10 mm solid shaft, circumference 500 mm	BEF-MR010050R	2055227	
	O-ring for measuring wheels (circumference 200 mm)	BEF-OR-053-040	2064061	
	O-ring for measuring wheels (circumference 300 mm), 2x O-ring	BEF-OR-083-050	2064076	
		Clamping ring for metal hollow shaft ¹⁾ , metal	BEF-KR-M	2064709
Plug connectors and cables				
	Head A: female connector, M12, 4-pin, straight, A-coded Head B: Flying leads Cable: Sensor/actuator cable, PUR, halogen-free, unshielded, 2 m	YF2A14-020UB3XLEAX	2095607	
	Head A: female connector, M12, 4-pin, straight, A-coded Head B: Flying leads Cable: Sensor/actuator cable, PUR, halogen-free, unshielded, 5 m	YF2A14-050UB3XLEAX	2095608	
	Head A: female connector, M12, 4-pin, straight, A-coded Head B: Flying leads Cable: Sensor/actuator cable, PUR, halogen-free, unshielded, 10 m	YF2A14-100UB3XLEAX	2095609	
	Head A: female connector, M12, 4-pin, straight, A-coded Head B: Flying leads Cable: Sensor/actuator cable, PUR, halogen-free, unshielded, 25 m	YF2A14-250UB3XLEAX	2095615	
	Head A: female connector, M12, 4-pin, angled, A-coded Head B: Flying leads Cable: Sensor/actuator cable, PUR, halogen-free, unshielded, 2 m	YG2A14-020UB3XLEAX	2095766	
	Head A: female connector, M12, 4-pin, angled, A-coded Head B: Flying leads Cable: Sensor/actuator cable, PUR, halogen-free, unshielded, 5 m	YG2A14-050UB3XLEAX	2095767	
	Head A: female connector, M12, 4-pin, angled, A-coded Head B: Flying leads Cable: Sensor/actuator cable, PUR, halogen-free, unshielded, 10 m	YG2A14-100UB3XLEAX	2095768	
	Head A: female connector, M12, 4-pin, angled, A-coded Head B: Flying leads Cable: Sensor/actuator cable, PUR, halogen-free, unshielded, 25 m	YG2A14-250UB3XLEAX	2095771	

	Brief description	Type	Part no.
	Head A: male connector, M12, 4-pin, straight, D-coded Head B: Flying leads Cable: Ethernet, PROFINET, PUR, halogen-free, shielded, 2 m	YM2D24-020PN1XLEAX	2106171
	Head A: male connector, M12, 4-pin, straight, D-coded Head B: Flying leads Cable: Ethernet, PROFINET, PUR, halogen-free, shielded, 5 m	YM2D24-050PN1XLEAX	2106172
	Head A: male connector, M12, 4-pin, straight, D-coded Head B: Flying leads Cable: Ethernet, PROFINET, PUR, halogen-free, shielded, 10 m	YM2D24-100PN1XLEAX	2106173
	Head A: male connector, M12, 4-pin, angled, D-coded Head B: Flying leads Cable: Ethernet, PROFINET, PUR, halogen-free, shielded, 5 m	YN2D24-050PN1XLEAX	2106175
	Head A: male connector, M12, 4-pin, angled, D-coded Head B: Flying leads Cable: Ethernet, PROFINET, PUR, halogen-free, shielded, 25 m	YN2D24-250PN1XLEAX	2106180
	Head A: male connector, M12, 4-pin, angled, D-coded Head B: male connector, M12, 4-pin, angled, D-coded Cable: PROFINET, PUR, halogen-free, shielded, 5 m	SSL-1204-W05MZ	6050636
	Head A: male connector, RJ45, 4-pin, straight Head B: male connector, M12, 4-pin, angled, D-coded Cable: PROFINET, EtherCAT®, PVC, shielded, 30 m	SSL-2J04-F30MZ	6059450
	Head A: male connector, M12, 4-pin, straight, D-coded Head B: male connector, RJ45, 4-pin, straight Cable: PROFINET, PVC, shielded, 5 m	SSL-2J04-G05MZ60	6048245
	Head A: male connector, M12, 4-pin, angled, D-coded Head B: male connector, RJ45, 8-pin, straight Cable: Ethernet, PUR, halogen-free, shielded, 20 m	SSL-2J04-H20ME	6063701
	Head A: male connector, M12, 4-pin, straight, D-coded Head B: male connector, RJ45, 4-pin, straight Cable: Ethernet, PROFINET, PUR, halogen-free, shielded, 2 m	YM2D24-020PN1MRJA4	2106182
	Head A: male connector, M12, 4-pin, straight, D-coded Head B: male connector, M12, 4-pin, angled, D-coded Cable: Ethernet, PROFINET, PUR, halogen-free, shielded, 2 m	YM2D24-020PN1N2D24	2106165
	Head A: male connector, M12, 4-pin, straight, D-coded Head B: male connector, M12, 4-pin, straight, D-coded Cable: Ethernet, PROFINET, PUR, halogen-free, shielded, 5 m	YM2D24-050PN1M2D24	2106160
	Head A: male connector, M12, 4-pin, straight, D-coded Head B: male connector, M12, 4-pin, angled, D-coded Cable: Ethernet, PROFINET, PUR, halogen-free, shielded, 5 m	YM2D24-050PN1N2D24	2106166
	Head A: male connector, M12, 4-pin, straight, D-coded Head B: male connector, M12, 4-pin, straight, D-coded Cable: Ethernet, PROFINET, PUR, halogen-free, shielded, 10 m	YM2D24-100PN1M2D24	2106161
	Head A: male connector, M12, 4-pin, straight, D-coded Head B: male connector, RJ45, 4-pin, straight Cable: Ethernet, PROFINET, PUR, halogen-free, shielded, 10 m	YM2D24-100PN1MRJA4	2106185
	Head A: male connector, M12, 4-pin, straight, D-coded Head B: male connector, M12, 4-pin, angled, D-coded Cable: Ethernet, PROFINET, PUR, halogen-free, shielded, 10 m	YM2D24-100PN1N2D24	2106167
	Head A: male connector, M12, 4-pin, angled, D-coded Head B: male connector, RJ45, 4-pin, straight Cable: Ethernet, PROFINET, PUR, halogen-free, shielded, 2 m	YN2D24-020PN1MRJA4	2106162
	Head A: male connector, M12, 4-pin, angled, D-coded Head B: male connector, M12, 4-pin, angled, D-coded Cable: Ethernet, PROFINET, PUR, halogen-free, shielded, 2 m	YN2D24-020PN1N2D24	2106168

	Brief description	Type	Part no.
	Head A: male connector, M12, 4-pin, angled, D-coded Head B: male connector, RJ45, 4-pin, straight Cable: Ethernet, PROFINET, PUR, halogen-free, shielded, 5 m Head A: male connector, M12, 4-pin, angled, D-coded Head B: male connector, RJ45, 4-pin, straight Cable: Ethernet, PROFINET, PUR, halogen-free, shielded, 10 m	YN2D24-050PN1MRJA4 YN2D24-100PN1MRJA4	2106163 2106164
	Head A: male connector, M12, 4-pin, angled, D-coded Head B: male connector, M12, 4-pin, angled, D-coded Cable: Ethernet, PROFINET, PUR, halogen-free, shielded, 10 m	YN2D24-100PN1N2D24	2106170
	Head A: female connector, M12, 4-pin, angled Cable: unshielded	DOS-1204-W	6007303
	Head A: male connector, M12, 4-pin, angled, D-coded Cable: PROFINET, shielded	STE-1204-WZ	6048262
	Head A: female connector, M12, 4-pin, D-coded Head B: female connector, RJ45, 8-pin Cable: Ethernet, shielded Cabinet through	Feedthrough female connector Ethernet RJ45	6048180

SICK AT A GLANCE

SICK is one of the leading manufacturers of intelligent sensors and sensor solutions for industrial applications. A unique range of products and services creates the perfect basis for controlling processes securely and efficiently, protecting individuals from accidents and preventing damage to the environment.

We have extensive experience in a wide range of industries and understand their processes and requirements. With intelligent sensors, we can deliver exactly what our customers need. In application centers in Europe, Asia and North America, system solutions are tested and optimized in accordance with customer specifications. All this makes us a reliable supplier and development partner.

Comprehensive services complete our offering: SICK LifeTime Services provide support throughout the machine life cycle and ensure safety and productivity.

For us, that is “Sensor Intelligence.”

WORLDWIDE PRESENCE:

Contacts and other locations –www.sick.com