



Product designation				Auxiliary contactor
Product type designation				BF00
Contact characteristics				
Number of poles	Nr.			4
Rated insulation voltage U_i IEC/EN	V			690
Rated impulse withstand voltage U_{imp}	kV			6
Operational frequency	min	Hz	25	
	max	Hz	400	
IEC Conventional free air thermal current I_{th}	A			10
Operational current I_e	AC-1 ($\leq 55^\circ\text{C}$)		A	0
	gG (IEC)		A	25
Tightening torque for terminals	min	Nm	1.5	
	max	Nm	1.8	
	min	lbin	1.1	
	max	lbin	1.5	
Tightening torque for coil terminal	min	Nm	0.8	
	max	Nm	1	
	min	lbin	0.8	
	max	lbin	0.74	
Max number of wires simultaneously connectable	Nr.			2
Conductor section	AWG/Kcmil			
	max			10
Flexible w/o lug conductor section	min	mm ²	1	
	max	mm ²	6	
Flexible c/w lug conductor section	min	mm ²	1	
	max	mm ²	4	
Flexible with insulated spade lug conductor section	min	mm ²	1	
	max	mm ²	4	
Power terminal protection according to IEC/EN 60529				IP20 when properly wired
Mechanical features				
Operating position	normal allowable		Vertical plan $\pm 30^\circ$	

Fixing				Screw / DIN rail 35mm
Weight	g			500
Conductor section	AWG/kcmil conductor section			
	max			10
Auxiliary contact characteristics				
Thermal current I _{th}	A			10
IEC/EN 60947-5-1 designation				A600 - P600
Operating current AC15				
	230V	A	3	
	400V	A	1.9	
	500V	A	1.4	
Operating current DC12				
	110V	A	5.7	
Operating current DC13				
	24V	A	5.7	
	48V	A	2.9	
	60V	A	2.3	
	110V	A	1.25	
	125V	A	1.1	
	220V	A	0.55	
	600V	A	0.2	
Operations				
Mechanical life	cycles			20000000
Safety related data				
Performance level B10d according to EN/ISO 13489-1	mechanical load			cycles 20000000
Mirror contacts according to IEC/EN 60947-4-1				YES
EMC compatibility				yes
DC coil operating				
DC rated control voltage	V			220
DC operating voltage				
	pick-up		min %Us	70
			max %Us	125
	drop-out		min %Us	10
			max %Us	40
Average coil consumption ≤20°C				
	in-rush	W	5.4	
	holding	W	5.4	
Max cycles frequency				
Mechanical operation	cycles/h			3600
Operating times				
Average time for U _s control				
	in DC			
	Closing NO			
	min	ms	54	
	max	ms	66	
	Opening NO			
	min	ms	14	
	max	ms	17	

Closing NC	min	ms	24
	max	ms	30
Opening NC	min	ms	47
	max	ms	57

UL technical data

General USE

Auxiliary contacts

AC current A 10

Contact rating of auxiliary contacts according to UL

A600 - P600

Ambient conditions

Temperature

Operating temperature

min °C -50
 max °C 70

Storage temperature

min °C -60
 max °C 80

Max altitude

m 3000

Resistance & Protection

Pollution degree

3

Dimensions

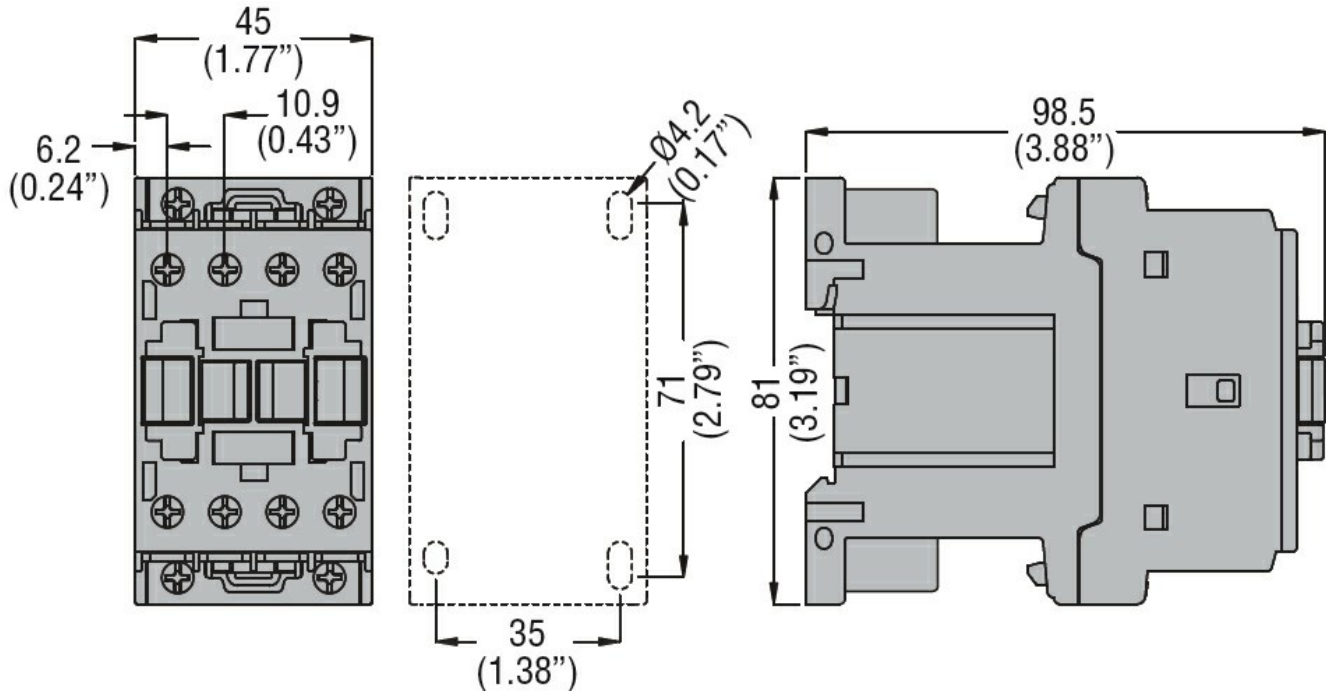

Wiring diagrams

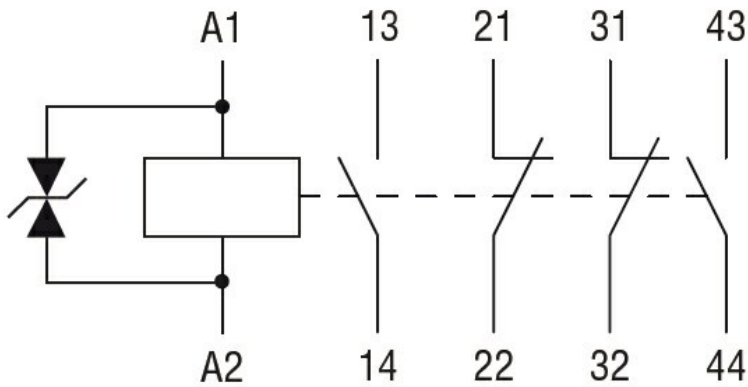

Certifications and compliance

Compliance

CSA C22.2 n° 60947-1

CSA C22.2 n° 60947-5-1

IEC/EN 60947-1

IEC/EN 60947-5-1

UL 60947-1

UL 60947-5-1

Certificates

CCC

cULus

EAC

ETIM classification

ETIM 8.0

EC000196 -
 Contactor relay