

## **XV360 Single Touch Display**



## **Company information**

All brand and product names are trademarks or registered trademarks of their respective owners.

### **Break-Down Service**

Please contact your local office:

<http://www.eaton.eu/aftersales>

or the After Sales Service

Hotline After Sales Service:

+49 (0) 180 5 223822 (de,en)

AfterSalesEGBonn@eaton.com

### **Original Operating Instructions**

is the German-language edition of this document

Publication date

07/2019 1st Edition, Version 0.0

Copyright

© 2015 by Eaton Industries GmbH, 53105 Bonn

Author: Antje Panten-Nonnen

Electrical Sector, Business Unit Industrial Automation

Editor: ICPD MOC

Eaton Industries GmbH, Hein-Moeller-Straße 7-11, D-53115 Bonn

All rights, including those of translation, reserved.

No part of this manual may be reproduced, stored in a retrieval system, or transmitted in any form or by any means, whether electronic, mechanical, photocopying, micro-filming, recording, or otherwise, without the prior written permission of Eaton Industries GmbH, Bonn.

Subject to alteration.



**DANGER!**

Dangerous electrical voltage!

---

## Before starting with the installation

- Installation requires qualified electrician
- Disconnect the power supply of the device.
- Secure against retriggering
- Verify isolation from the supply
- Ground and short-circuit
- Cover or enclose any neighboring live parts.
- Follow the engineering instructions (IL) of the device concerned.
- Only suitably qualified personnel in accordance with EN 50110-1/-2 (VDE 0105 part 100) may work on this device/system.
- Before installation and before touching the device ensure that you are free of electrostatic charge.
- The functional earth (FE) must be connected to the protective earth (PE) or to the equipotential bonding. The system installer is responsible for implementing this connection.
- Connecting cables and signal lines should be installed so that inductive or capacitive interference does not impair the automation functions.
- Install automation devices and related operating elements in such a way that they are well protected against unintentional operation.
- Suitable safety hardware and software measures should be implemented for the I/O interface so that a line or wire breakage on the signal side does not result in undefined states in the automation devices.
- Deviations of the mains voltage from the nominal value must not exceed the tolerance limits given in the specifications, otherwise this may result in malfunction and hazardous states.
- Emergency-Stop devices complying with IEC/EN 60204-1 must be effective in all operating modes of the automation devices. Unlatching the emergency stop devices must not result in an automatic restart.
- Built-in devices for enclosures or cabinets must only be run and operated in an installed state; desktop devices and portable devices only when the housing is closed.
- Measures should be taken to ensure the proper restarting of programs interrupted after a voltage dip or outage. This should not result in dangerous operating states even for a short time. If necessary, emergency stop devices should be implemented.
- Wherever faults in the automation system may cause damage to persons or property, external measures must be implemented to ensure a safe operating state in the event of a fault or malfunction (for example, by means of separate limit switches, mechanical interlocks, etc.).



## Table of Contents

	<b>XV360 Single Touch Display Manual</b> .....	<b>1</b>
	Company information .....	2
	Before starting with the installation .....	1
	Table of Contents .....	5
0.1	About this documentation .....	8
0.1.1	List of revisions .....	8
0.1.2	Target group .....	9
0.1.3	Legal disclaimer .....	10
0.1.4	Device designations and abbreviations .....	10
0.1.5	Writing conventions .....	11
0.1.5.1	Warning labels .....	11
0.1.5.2	Documents with additional information .....	12
<b>1.</b>	<b>Description</b> .....	<b>13</b>
1.1	Basic equipment - common features of the model series .....	13
1.2	Device variants options .....	14
1.3	Intended use .....	14
1.4	Variants and types .....	15
1.5	Operating and indication elements .....	16
1.5.1	Overview .....	16
1.6	Interfaces to peripheral devices .....	17
1.7	What the different parts of the part number mean .....	18
1.8	Accessory devices .....	19
1.9	Nameplate .....	20
1.10	Support .....	20
<b>2.</b>	<b>Safety regulations</b> .....	<b>21</b>
2.1	Basics .....	21
2.2	Mandatory requirements, personnel requirements .....	21
2.2.1	Occupational safety .....	21
2.2.2	Personnel qualifications .....	21
2.2.3	Device documentation .....	21

2.2.4	Installation, maintenance, and disposal .....	22
2.2.5	Prerequisites for proper operation .....	22
2.3	Device-specific hazards .....	23
<b>2.</b>	<b>Installation .....</b>	<b>28</b>
2.4	Prerequisites for the location of use .....	28
2.4.1	Installation position .....	29
2.4.1.1	Temperatures .....	30
2.4.1.2	Aeration and de-aeration .....	31
2.5	Unpacking and checking the equipment supplied .....	32
2.6	Mounting .....	33
2.7	Preparations .....	34
2.8	XV-363 mounting .....	38
2.9	Preparing the device for operation .....	39
2.9.1	Power supply - electrical connection .....	40
<b>3.</b>	<b>Commissioning .....</b>	<b>43</b>
3.1	Initial commissioning .....	43
3.2	Running the XV-363 .....	44
<b>4.</b>	<b>External connections .....</b>	<b>45</b>
4.1	Layout of interfaces .....	46
4.2	SD card .....	47
4.3	USB interfaces .....	48
4.3.1	USB host .....	48
4.3.2	USB device .....	48
4.4	Ethernet 1, Ethernet 2 .....	49
4.5	Serial interfaces for communication with PLCs or devices .....	50
4.5.1	COM1 RS-232 .....	50
4.5.1.1	Wiring topic .....	51
4.5.2	COM2 RS-485 .....	52
4.5.2.1	Wiring topic .....	52
4.5.2.2	RS-485 topology .....	53
4.6	CAN1 interface for the CANopen protocol, J1939 protocol, etc. ..	54
4.6.0.1	Wiring topic .....	55
4.6.0.2	CAN-Bus-topology .....	57

4.7	Profibus Interfaces .....	58
4.7.0.1	Wiring topic .....	59
4.7.0.2	Profibus topology .....	60
<b>5.</b>	<b>Faults</b> .....	<b>61</b>
<b>6.</b>	<b>Maintenance</b> .....	<b>63</b>
6.1	Cleaning and maintenance .....	63
6.1.1	Cleaning the infrared touchscreen .....	63
6.1.2	Battery .....	63
6.2	Repairs .....	64
6.3	Storage, transport and disposal .....	65
6.3.1	Storage and transport .....	65
6.3.2	Disposal .....	66
	<b>Appendix</b> .....	<b>67</b>
A.1	Technical data .....	68
A.1.1	Data sheets .....	68
A.1.2	Dimension and weight specifications .....	69
A.1.2.1	XV-363-57-.. .....	69
A.1.2.2	XV-363-10-.. .....	70
A.1.2.3	XV-363-12-.. .....	71
A.1.2.4	Hole diameter built-in .....	72
A.1.3	General data .....	73
A.1.4	Port and interface specifications .....	75
A.1.5	Information on the power supply .....	76
A.1.6	Approvals and declarations .....	77
A.2	Further reading .....	78
	Alphabetical index .....	79

## 0.1 About this documentation

### 0.1 About this documentation

This Manual contains all the information you will need in order to use the XV360 Single Touch Display safely and effectively.

The Manual XV360 Single Touch Display manual is considered an integral part of the devices and must always be readily available in the device's close proximity so that users have access to it.

This Manual describes all of the devices' lifecycle stages: transportation, installation, commissioning, operation, maintenance, storage, and disposal.

It assumes you have electrical engineering knowledge and skills.

It does not, however, go over the corresponding operating system or application software.

Make sure to always use the latest documentation for your device.



Manual XV360 Single Touch      MN048025EN  
Display

The latest version of this documentation, as well as additional references, is available for download on the Internet. → Section "Further reading", page 78



<http://www.eaton.eu/doc>

Please send any comments, recommendations, or suggestions regarding this document to: [AfterSalesEGBonn@eaton.com](mailto:AfterSalesEGBonn@eaton.com)

#### 0.1.1 List of revisions

The following significant amendments have been introduced since previous issues:

Publication date	Page	Keyword	New	Modification	Deleted
07/2019		New edition	✓		



### 0.1.2 Target group

This Manual is intended for electricians and electrical engineers, as well as for the people who will be in charge of performing the electrical installation and people who will be using the XV360 Single Touch Display as an operating and monitoring device or as an integrated operating and control device in their own applications.



#### **CAUTION**

Installation requires qualified electrician



#### **Follow the safety instructions for the XV-363!**

The section on safety instructions must be read and understood by everyone who will be working with the XV-363 before the actual work is performed Human-machine interface.



#### **WARNING**

##### **Incomplete operator manual copies**

Working with individual pages taken out from the operator manual may lead to bodily injury and property damage due to failure to observe relevant safety information.

- ▶ Always work with the latest and full document.

## 0.1 About this documentation

### 0.1.3 Legal disclaimer

All the information in this manual has been prepared to the best of our knowledge and in accordance with the state of the art. However, this does not exclude the possibility of there being errors or inaccuracies. We assume no liability for the correctness and completeness of this information. In particular, this information does not guarantee any particular properties.

Do not use the XV360 Single Touch Display before reading and understanding this manual.

It is assumed that the user of this manual is thoroughly familiar with the information found in the manuals for incorporating the XV360 Single Touch Display into automation processes.

Hazards posed by the XV-363 cannot be eliminated if the safety instructions are not observed – especially if the XV360 Single Touch Display is commissioned and maintained by unqualified personnel and/or the XV-363 is used improperly. Eaton assumes no liability for any damages resulting from cases such as these.

### 0.1.4 Device designations and abbreviations

The following general terms are used throughout this manual:

Short designation	Explanation
XV360 Single Touch Display	Product family with function code
Human-machine interface	Family
XV-363	Used to refer to all the devices in the product family
XV-363	Used to refer to all front mounting devices as a group



For the exact designation for your XV360 Single Touch Display, please refer to the → "Nameplate", page 20.

0.1.5 Writing conventions

<b>Award</b>	<b>Description</b>
<b>Bold text</b>	Used for all graphical user interface elements
Monospaced	Used for all elements at the file level
Font format code	
<code>Text</code>	Used for the button labels
<i>Menu path\submenu... item</i>	Path information for software windows and menu pages
<i>Menu/command</i>	Used for commands found in the menu bar's menus
<name>	Angle brackets are used to indicate variable values that you must replace with your own values

0.1.5.1 Warning labels

**Risk of personal injury warning.**

	<b>DANGER</b> Warns of hazardous situations that result in serious injury or death.
--	--

	<b>WARNING</b> Warns of the possibility of hazardous situations that could result in serious injury or even death.
---	---

	<b>DANGER!</b> Dangerous Electrical Voltage!
---	---

	<b>CAUTION</b> Warns of the possibility of hazardous situations that can cause injury.
---	---

**Property damage warning**

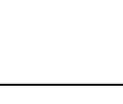
	<b>NOTICE</b> Warns about the possibility of material damage.
---	--

**Prohibited use**

	<b>Prohibited uses, actions, etc.</b> Explanation
---	--

## 0.1 About this documentation

### Bids

	<b>Bid</b> Explanation
---	---------------------------

### Notes



Indicates useful tips.

► Indicates instructions to be followed



Additional information, background information, information worth knowing, useful additional information

### 0.1.5.2 Documents with additional information

Manuals, for example. These will be listed with the corresponding title and Eaton number after the  icon.



Publication title

For identifying the Eaton publication code

External Internet addresses. They will be shown after the  icon.



Destination address

### 1.1 Basic equipment - common features of the model series

## 1. Description

XV360 Single Touch Display units are designed to be used as control and monitoring devices. In addition, they can also be used as an HMI (human-machine interface) when upgraded with an additional PLC functionality.

The devices require little space and are intended for front flush mounting, meaning that they are inserted into the corresponding enclosure from the front.

XV-363 units can also be used in portrait mode.

### 1.1 Basic equipment - common features of the model series

All XV-363 are equipped with:

1. Powerful CPU: ARM Cortex-A9 800 MHz
2. 1 GB internal memory and 128 kB non-volatile data memory (DRAM: 512 MB RAM, flash memory: 1 GB SLC, NVRAM: 128 kB Retain)
3. Industrial Infra-red touch display with Laminated safety glass, non-reflective, in aluminum bezel
4. SD/SDHC memory card slot
5. Operating System Windows Embedded Compact 7 pro
6. Every Human-machine interface comes with a comprehensive basic configuration with integrated interfaces.
  - Two Ethernet ports (10/100 Mbit/s) for use as a communication or field bus interface
  - One USB 2.0 host port for memory and other accessories, full power (500 mA)
  - One USB device 2.0,
  - One standard RS-232 (COM1) port for communicating with PLCs or devices,
  - One standard RS-485 (COM2) port for communicating with PLCs or devices,
  - One standard CAN interface for the CANopen protocol, J1939 protocol
7. Available PLC functionality upgrade  
In order to upgrade a unit to an HMI that can be used for control and operating purposes, use license product certificate LIC-PLC-A, part No. 181585.

## 1. Description

### 1.2 Device variants options

### 1.2 Device variants options

The device type XV-363-..-C02-...-.. comes with another integrated interface

- 1 x Profibus DP, universal field bus interface for all typical protocols

Three display sizes, screen diagonals 5.7", 10.4", or 12.1" with 4:3 aspect ratio are available

- XV-363-57-.. Display size 5.7",  
Visible screen area 115 mm x 86 mm, VGA 640 px x 480 px
- XV-363-10-.. Display size 10.4",  
Visible screen area 211 mm x 158 mm, VGA 640 px x 480 px
- XV-363-12-..., Display size 12.1",  
Visible screen area 246 mm x 185 mm, SVGA 800 px x 600 px

### 1.3 Intended use

XV360 Single Touch Display are primarily intended for use in machine and system building applications.

They are intended exclusively for monitoring, operating, and controlling machines and systems.

Any other use must be discussed and agreed upon with the manufacturer in advance.

The XV-363 are approved for use in closed spaces.



#### **Bid**

The Human-machine interface must be used only in locations for which the XV-363 is approved. Make sure to read and follow the information and labels on the nameplate for the Human-machine interface, as well as section Approvals and declarations in the appendix.



#### **Prohibited uses, actions, etc.**

It is strictly prohibited to use the device in order to implement safety-relevant functions (in the sense of personal and machine protection).

## 1.4 Variants and types

### Overview of available XV-363 devices

Make sure to take advantage of the EATON online catalog. Enter "XV-363" into the search box and the catalog will take you directly to the corresponding product group in the Automation, Control and visualization section.

 <http://www.eaton.eu/ecat>

#### Article no. and type

#### Description

197664 - XV-363-57-C00-A00-1 B

User interface 5.7-inch display,  
24VDC, IR, 640 x 480 pixels,  
2xEthernet, 1xRS232, 1xRS485, 1xCAN,  
PLC function can be added

197665 - XV-363-10-C00-A00-1 B

User interface 10.4-inch display,  
24VDC, IR, 640 x 480 pixels,  
2xEthernet, 1xRS232, 1xRS485, 1xCAN,  
PLC function can be added

197666 - XV-363-12-C00-A00-1 B

User interface 12.1-inch display,  
24VDC, IR, 800 x 600 pixels,  
2xEthernet, 1xRS232, 1xRS485, 1xCAN,  
PLC function can be added

197667 - XV-363-57-C02-A00-1 B

User interface 5.7-inch display,  
24VDC, IR, 640 x 480 pixels,  
2xEthernet, 1xRS232, 1xRS485, 1xCAN, 1xDP,  
PLC function can be added

197668 - XV-363-10-C02-A00-1 B

User interface 10.4-inch display,  
24VDC, IR, 640 x 480 pixels,  
2xEthernet, 1xRS232, 1xRS485, 1xCAN, 1xDP,  
PLC function can be added

197669 - XV-363-12-C02-A00-1 B

User interface 12.1-inch display,  
24VDC, IR, 800 x 600 pixels,  
2xEthernet, 1xRS232, 1xRS485, 1xCAN, 1xDP,  
PLC function can be added

## 1. Description

### 1.5 Operating and indication elements

## 1.5 Operating and indication elements

### 1.5.1 Overview

#### Operator control and display elements

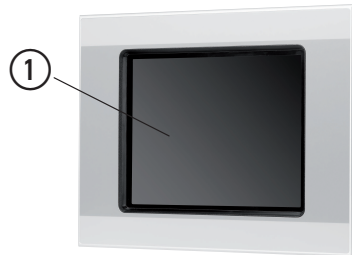

Front XV-363 Infra-red touch display

Color display, TFT Laminated safety glass, non-reflective, in aluminum bezel



Service side with optional interfaces XV-363

- |   |                                |   |
|---|--------------------------------|---|
| ① | Display, Infrared touch sensor | Display of HMI device<br>Detects when the controls shown on the display are being actuated. |
| ② | SD card slot                   | Slot for SD card  |
| ③ | CTRL button                    | The specific function depends on the software being used                                    |

#### Infra-red single touch

The unit is operated by disrupting the grid-like array of infrared light beams with a finger or a suitable object (min. diameter of 7 mm). The infrared touchscreen glass does not actually need to be touched.



## 1.6 Interfaces to peripheral devices

The interfaces featured by your XV360 Single Touch Display will depend on the version selected and cannot be modified.

The nameplate will indicate which specific interfaces are included with the unit.

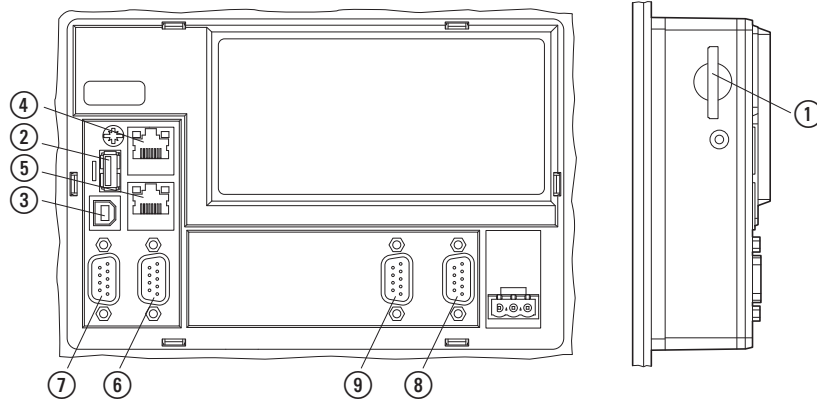

Fig. 1: Interfaces

### Interfaces Basic equipment (all XV-363 models)

Interface	Version
① SD card slot	SDSC or SDHC conforming to the SDA 2.0 specification
② USB host	USB 2.0, not galvanically isolated, plug type A, Full power (500 mA)
③ USB device	USB 2.0, not galvanically isolated, plug type B
④ Ethernet 1	RJ-45 socket, 8-pole, 2 LEDs (CAT5e/6), LAN1, 10/100 Mbps
⑤ Ethernet 2	RJ-45 socket, 8-pole, 2 LEDs (CAT5e/6), LAN1, 10/100 Mbps
⑥ COM1	RS-232, not galvanically isolated, SUB-D plug 9-pole, UNC nuts for interlocking
⑦ COM2	RS-485, not galvanically isolated, SUB-D plug 9-pole, UNC nuts for interlocking
⑧ CAN	CAN1, not galvanically isolated, SUB-D plug 9-pole, UNC nuts for interlocking

### Optional interfaces XV-363-...-C02-...-..

⑨ Profibus	Profibus DP, not galvanically isolated, SUB-D socket 9-pole, UNC nuts for interlocking
------------	--

## 1. Description

### 1.7 What the different parts of the part number mean

#### 1.7 What the different parts of the part number mean

The Part number includes information that specifies the version and model of the specific device being used.

The Part number can be found at the type plate of the XV360 Single Touch Display.

Tab. 1: Part number

<b>XV</b>	-	<b>363</b>	-	..	-	...	-	...	-	..
		Version		Display size		Interfaces		Version		Visualization software

Tab. 2: Version

<b>363</b>	
363	Front mounting, infrared

Tab. 3: Display size

..	
57	5.7" screen diagonal
10	10.4" screen diagonal
12	12.1" screen diagonal

Tab. 4: Interfaces

..	
C00	Base (2xEthernet, 1xRS232, 1xRS485, 1xCAN, 1x USB host, 1xUSB device, 1xSD card slot)
C02	Base + 1xProfibus

Tab. 5: Version

...	
A00	Standard version

Tab. 6: Bundles with visualization software

..	
1B	WEC7P, runtime license for GALILEO visualization software; PLC function can be added later on

## 1.8 Accessory devices

A variety of accessories are available for XV-363s.

- SD card
- Accessories

**NOTICE**

Only use original accessories.



Order accessories through your supplier or through the Eaton online catalog [www.eaton.eu/ecat](http://www.eaton.eu/ecat)

Example:

article no.	Catalog Number
139807	MEMORY-SD-A1-S SD memory card with min. 256 MByte
181638	MEMORY-SD-A2-S SD memory card with min. 1 GB
181585	LIC-PLC-A License product certificate for PLC upgrading
139828	ACCESSORIES-TP-57-IR-1 for XV-363-57-.. Included as standard of the device
139843	ACCESSORIES-TP-15-IR-1 for XV-363-10-.. and XV-363-12-.. Included as standard with the device

## 1. Description

### 1.9 Nameplate

### 1.9 Nameplate

The device has a nameplate on rear.

This nameplate includes the following information:

- Manufacturer
- Part number
- Part-No.
- Version
- Date of manufacture
- Required power supply
- Serial-No.
- Type approval and certification marks and information
- Layout of ports/interfaces and controls

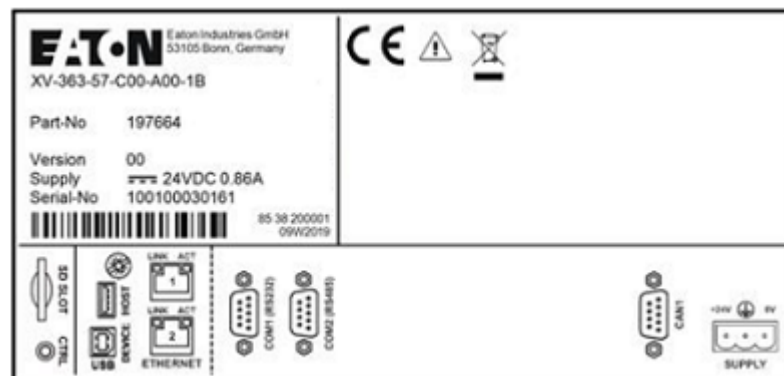

Fig. 2: Example for a nameplate

### 1.10 Support

To get fast and effective support, make sure to always provide Customer Service with the following information from the nameplate:

- Part-No.
- Serial-No

## **2. Safety regulations**

### **2.1 Basics**

The device has been designed according to the state of the art and all generally accepted safety rules and standards. However, this alone cannot eliminate all potential hazards, which is why it is necessary for you to be aware of all hazards and residual risks.

Do not run the device unless it is in perfect technical condition. Make sure to always operate it as specified in this document and for the intended purpose.



**Follow the safety instructions for the XV-363!**

The section on safety instructions must be read and understood by everyone who will be working with the XV-363 before the actual work is performed Human-machine interface.

**NOTICE**

Pay attention to the hazard severity levels used throughout this documentation whenever a hazard is indicated. The hazard symbol and signal word used and the corresponding text will provide information regarding the specific hazard and how to avoid or prevent it.

## **2.2 Mandatory requirements, personnel requirements**

### **2.2.1 Occupational safety**

All generally accepted occupational health and safety rules and standards (internal and national) must be complied with, as must be all applicable laws and regulations in the relevant country.

### **2.2.2 Personnel qualifications**

The personnel responsible for installation, operation, maintenance, and repairs must have the necessary qualifications for the work they will be performing. They must be appropriately trained and/or briefed and be informed of all hazards and risks associated with the device.

### **2.2.3 Device documentation**

This manual is considered an integral part of the XV-363 and must always be readily available in the device's close proximity so that users have access to it.

## 2. Safety regulations

### 2.2 Mandatory requirements, personnel requirements

Make sure that every person who will be working with the XV-363, regardless of the lifecycle stage involved, has read and understood the relevant parts of the documentation for the XV-363.

Additional parts of the documentation and information for the XV-363, including the installation instructions, can be found at the Eaton Download Center - Documentation and at the product pages on the Internet

 <http://www.eaton.eu/doc>

 <http://www.eaton.eu/xv300>



#### **WARNING**

##### **Incomplete operator manual copies**

Working with individual pages taken out from the operator manual may lead to bodily injury and property damage due to failure to observe relevant safety information.

▶ Always work with the latest and full document.

#### 2.2.4 Installation, maintenance, and disposal

Make sure that the XV-363 is connected, installed, serviced, and disposed of professionally and in line with all relevant standards and safety rules.



#### **CAUTION**

Installation requires qualified electrician



#### **Important!**

Dispose of recyclables as required by your local recycling regulations.

Human-machine interface XV-363 no longer being used must be professionally disposed of as per local standards or returned to the manufacturer or relevant sales department.

#### 2.2.5 Prerequisites for proper operation

In order for the device to be able to meet the contractually stipulated terms, the following must be observed:

- Only qualified personnel should be allowed to work with the XV-363.
- The personnel working with the XV-363 must have read the manual and must follow all the instructions in it.
- The required ambient conditions must be met.
- Maintenance work must be carried out correctly.



Make sure to read the → "Legal disclaimer", page 10.

We assume no liability for damages, consequential damages, and/or accidents caused by the following:

- Failure to follow any applicable occupational health and safety rules, standards, and/or regulations
- Device failures or function disturbances
- Improper use and/or handling
- Not following the instructions or observing the information in the documentation for the XV-363
- Alterations, changes, and repairs to the XV-363

## 2.3 Device-specific hazards



### **EXPLOSION HAZARD**

Death, serious injury, and property damage may occur if the device is being used in a potentially explosive (classified) location and, during operation, an electrical plug-in connection is disconnected or the device is exposed to dangerous impacts or other types of dangerous mechanical shock.

- ▶ Use the device in the following environments only:
  - Non-hazardous (non-explosive) areas
  - Potentially explosive atmosphere, Zone 22 (according to ATEX Directive)
- ▶ The ground resistance of accessible metal parts must be less than  $10^9$  ohms.
- ▶ Make sure that the device is not exposed to dangerous impacts and other types of dangerous mechanical shock.
- ▶ De-energize the device before disconnecting plug connections.
- ▶ Clean only with a clean soft antistatic damp cloth.
- ▶ When used in a potentially explosive atmosphere, Zone 22:  
The XV-363 is designed for installation in the front of enclosures in protection type "tc" (alternatively "ta" or "tb"). This installation must be tested and certified separately. The maximum surface temperature at the outer surface is set to 70°C at the maximum ambient temperature of 50°C. The environment has to be designed to avoid any bunch discharge. For safe installation, comply with the specification to holding brackets and tightening torque in the Instruction Leaflet IL048014ZU.

## 2. Safety regulations

### 2.3 Device-specific hazards



#### **EXPLOSION HAZARD LITHIUM BATTERY**

The lithium battery inside the XV-363 may explode if handled incorrectly.



#### **CAUTION DESTRUCTION**

The XV-363 should only be opened by the manufacturer or by an authorized center. Operate the Infra-red touch display until only with the enclosure fully closed and sealed.



#### **CAUTION ELECTROSTATIC DISCHARGE**

Do not touch components (e.g., connector pins) that are electrostatic-sensitive.

- ▶ Discharge any static electricity from your body before touching the XV-363 (e.g., by touching an earthed metal object).

Electrostatic discharges may damage or ruin assembly parts. Because of this, it is necessary to take precautions whenever handling the cards. Please refer to the guidelines for electrostatic-sensitive components for more information (ESD guidelines).



#### **CAUTION INTERFERENCES**

The values specified in the technical data, as well as the device's electromagnetic compatibility (EMC), cannot be guaranteed if the following are used: unsuitable cables, improperly assembled and terminated cables, and/or wiring that does not conform to the applicable standards. Only use cables assembled and terminated by professionals.

The cables being used must be assembled and terminated as required by the port/interface description in this document.

When wiring the XV-363, follow all instructions regarding how to wire the corresponding port/interface.

All general Directives and standards must be complied with.



#### **CAUTION INTERFERENCES**

Screw all plug-in connections or lock them into place in order to improve screening.

Signal cables must not be routed in the same cable duct with power cables.



## 2. Safety regulations

### 2.3 Device-specific hazards

Before putting the system into operation, check all cable connections to make sure that everything has been wired properly.  
Make sure that all voltages and signals have the required values as per the specification.



#### **DANGER** **STRAY CURRENTS**

Large equalizing currents between the functional earthing system and the ground system of different devices may result in fire or in malfunctions due to signal interference.

- ▶ If necessary, route an equipotential bonding conductor, with a cross-sectional area that is several times larger than that of the cable shielding, parallel to the cable.



#### **CAUTION** **NON-GALVANICALLY-ISOLATED INTERFACES**

The XV-363 may be damaged by potential differences.

- ▶ The GND terminals of all bus modules must be connected.
- ▶ Do not connect the connector to the XV-363 or disconnect it without first de-energizing the system.



#### **CAUTION** **DATA LOSS**

If the SD card is being written to and a voltage drop occurs or the card is removed, data may be lost or the SD card may be ruined.

- ▶ Insert the SD card only when the XV-363 is de-energized.
- Observe the following if you are using the SD card to store data:
- SD cards have a limited number of write cycles.
  - If there is a voltage drop while a write operation is in progress, data loss is highly likely to occur.
- ▶ Remove the SD card only when the XV-363 is de-energized.
  - ▶ Before switching off the device, make sure that there are no programs writing to the SD card.

## 2. Safety regulations

### 2.3 Device-specific hazards



#### **CAUTION SHORT-CIRCUIT HAZARD**

If the Infra-red touch display is or has been exposed to environmental fluctuations (ambient temperature, air humidity), condensation may form on or inside it. As long as this condensation is present, there will be a short-circuit hazard.

Do not switch on the device when it has condensation in or on it.

If the Infra-red touch display has condensation in or on it, or if it has been exposed to environmental fluctuations, let the XV-363 settle into the existing ambient temperature before switching it on. Do not expose the device to direct thermal radiation from heating appliances.



#### **CAUTION UV LIGHT**

Plastics will become brittle when exposed to UV light. This artificial aging will reduce the XV-363 unit's lifespan. Sunrays will disrupt the infrared touch sensor.

Protect the Infra-red touch display unit from direct sunlight and other sources of UV radiation.



#### **CAUTION POINTY, SHARP OBJECTS AND CORROSIVE LIQUIDS**

When cleaning the Infra-red touch display:

- Do not use any pointy or sharp objects (e.g., knives).
- Do not use aggressive or abrasive cleaning products or solvents.

Make sure that no liquids get into the device (short-circuit hazard) and that the XV-363 is not damaged in any way.



#### **CAUTION INSTALLATION CUT-OUT**

The mounting cutout must be located in a position that will not defeat the purpose of stabilizing webs or other reinforcing elements in the control panel. If necessary, reinforcing elements must be installed/added.

An IP65 degree of protection will only be ensured if there is sufficient stiffness and the device is properly mounted.

- Minimum sheet thickness of control panel panel where the device will be flush mounted:  
 $2 \text{ mm (0.08")} \leq d \leq 5 \text{ mm (0.2")}$

## 2. Safety regulations

### 2.3 Device-specific hazards



#### **CAUTION** **POOR SEALING**

If the gasket cord is twisted when placed inside the groove or does not provide adequate sealing all around, the degree of protection will not be achieved.

The join of the sealing strip must be positioned on the bottom of the device.



#### **CAUTION**

When using commercially available peripheral devices (e.g., with the USB port), it is important to keep in mind that their EMC interference immunity parameters may render them unsuitable for use in industrial environments.

The USB ports (USB host and USB device) on the XV-363 are intended exclusively for maintenance work.



#### **WARNING**

The device should only be run with safety extra-low voltage (functional extra-low voltage with protective separation).

The power transformer must conform to the relevant standards.



#### **CAUTION** **FORCES ON THE ETHERNET INTERFACE**

Communications may be affected, and the connection's mechanical components may be damaged, if the Ethernet interface is subjected to strong vibrations or the RJ45 plug-in connection is subjected to pulling.

- Protect the RJ45 plug-in connection from strong vibrations.
- Protect the RJ45 plug-in connection from tensile forces at the socket.



#### **WARNING**

XV-363 units are products designed for use in industrial environments as defined in ICE/EN 6100-6-4. These products can cause radio interference in domestic environments. In this case, the party operating the products must implement appropriate radio interference suppression measures.



#### **CAUTION**

Installation requires qualified electrician

## 2. Installation

### 2.4 Prerequisites for the location of use

## 2. Installation



#### CAUTION

#### ELECTROSTATIC DISCHARGE

Do not touch components (e.g., connector pins) that are electrostatic-sensitive.

- ▶ Discharge any static electricity from your body before touching the XV-363 (e.g., by touching an earthed metal object).

Electrostatic discharges may damage or ruin assembly parts. Because of this, it is necessary to take precautions whenever handling the cards. Please refer to the guidelines for electrostatic-sensitive components for more information (ESD guidelines).

### 2.4 Prerequisites for the location of use

The XV-363 must be used as intended and exclusively in locations for which the Human-machine interface has been approved/certified.

A 24 VDC supply voltage must be ensured as per the specifications.

XV-363 units are intended to be flush mounted in control cabinets, control panels, or control consoles.

- The units can be installed in landscape or portrait mode.

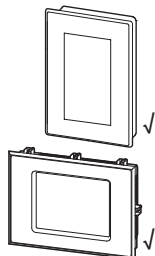

#### See also

→ "Intended use", page 14

Label on the → "Nameplate", page 20

The specifications in the appendix → "Technical data", page 68

### 2.4.1 Installation position

The following must be taken into account when selecting the installation position:

- If you will be using the Human-machine interface in a hazardous (explosive) location, make sure it is not exposed to any dangerous impacts or other types of dangerous mechanical shock.
- Make sure that the material at the installation location is sufficiently thick  $2 \text{ mm (0.08")} \leq d \leq 5 \text{ mm (0.2")}$ , and flat  $\square \leq 0.5 \text{ mm (0.02")}$  at the installation cutout with a surface roughness  $\checkmark R_z \leq 120$ ; IP 65  $\rightarrow$  DIN ISO 2768-2 (K)
- Make sure that the controls and connectors on the device's service side will remain accessible after the device has been installed.



The SD card slot is located on the side of the XV-363. Do not install the device with the SD card slot facing downwards, as the SD card may fall out. Make sure to take the space required to remove the SD card into account.

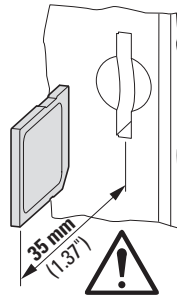

Fig. 3: Space required to remove the SD card

- No direct sunlight on the device.



**CAUTION  
UV LIGHT**

Plastics will become brittle when exposed to UV light. This artificial aging will reduce the XV-363 unit's lifespan. Sunrays will disrupt the infrared touch sensor. Protect the Infra-red touch display unit from direct sunlight and other sources of UV radiation.

## 2. Installation

### 2.4 Prerequisites for the location of use

#### 2.4.1.1 Temperatures

Make sure that the XV-363 does not overheat.

Do not expose the Infra-red touch display to direct sunlight or other sources of heat. The minimum clearance to components emitting heat, such as transformers under heavy loads, is 15 cm.

The environmental ambient conditions for operation must not exceed the specified values:

<b>Ambient climatic conditions</b>	
Air pressure (in operation)	795 - 1080 hPa Max. 2000 m above sea level
Temperature	
Operation	± 0 – +50 °C (+32 – +122 °F)
Storage / Transport	-20 – + 60 °C (-4 – +140 °F)
Humidity	Relative humidity 10 - 95 %
Condensation	non-condensing

## 2. Installation

### 2.4 Prerequisites for the location of use

#### 2.4.1.2 Aeration and de-aeration

- Do not block the ventilation openings when mounting the device:  
They are designed to allow the air to circulate in order to cool the XV-363.
- The XV-363 uses natural convection-based passive cooling, i.e., it does not use fans.

Ventilation diagram



Fig. 4: Cooling air circulation

Clear Zone

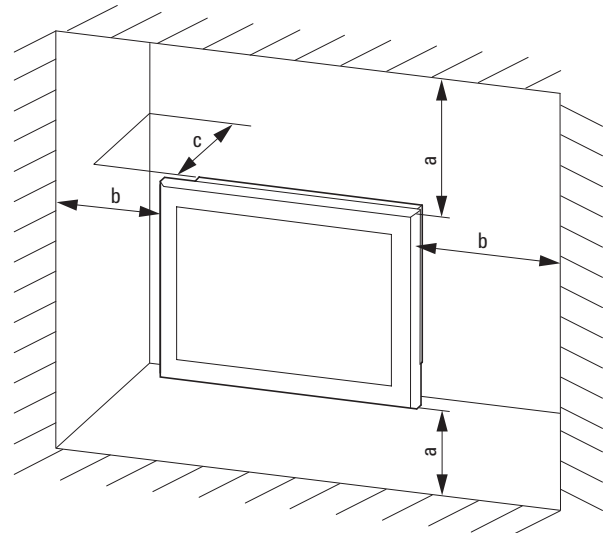

Fig. 5: Mounting distance

- Make sure that there will be enough volume for air changes inside the control panel, etc.  
The specified clearance around the XV-363 is:  $a, b, c \geq 30 \text{ mm (1.18")}$
- If you will be installing the XV-363 in complex systems together with other assemblies, you must ensure that there will be enough air circulation in order to prevent overheating.  
Ambient temperature with natural convection:  $9 \text{ } 0^{\circ}\text{C (32}^{\circ}\text{F)} \leq T \leq 50^{\circ}\text{C (122}^{\circ}\text{F)}$   
The panel builder is responsible for the temperature rise calculation. Eaton will provide heat dissipation data for the XV-363 as necessary for design verification in accordance with IEC EN 61439.

## 2. Installation

### 2.5 Unpacking and checking the equipment supplied

#### 2.5 Unpacking and checking the equipment supplied

- ▶ Check the Human-machine interface's packaging for transit damage.
- ▶ Carefully remove the packaging in order to avoid damaging the device.
- ▶ Check the package contents for visible transit damage.
- ▶ Use the information in Installation instructions IL048014ZU to make sure that the contents are complete.







Keep the original packaging so that you will be able to use it in the future if you need to transport or ship the Human-machine interface. Make sure to also keep the documents enclosed with the device and/or to give them to the end customer.

#### Missing parts or damage

If you notice anything wrong, please contact your distributor or Eaton Service +49 (0) 180 5 223822 (de,en)

The package for the XV360 Single Touch Display comes with:

Tab. 7: Std. pack

Unit	Description
1 x 	XV-363-57-..., XV-363-10-.. or XV-363-12-..
1 x 	Plug connector MSTB 2.5/3-ST-5.08
1 x	Installation instructions IL048014ZU
8 x 	Holding bracket with set screw Internal hexagon M 4 x 25 DIN 914 galvanized
1x 	Gasket cord Cord gasket XV-363-57-...: NR material, foamed, light gray, diameter of 3.1 mm (0.12") 800 mm (31.5") or for XV-363-10-.. and XV-363-10-...: EPDM material, light gray cellular rubber, diameter of 4.1 mm (0.16") 1300 mm (51.2")

The Infra-red touch display is sturdily built, but the components inside it are sensitive to excessively strong vibrations and/or mechanical shock.

Accordingly, make sure to protect the XV-363 from mechanical loads that exceed the scope of the unit's intended use.

The device should only be transported in its original packaging after being packed properly.



## 2.6 Mounting

*NOTICE*

Arrange for a professional technician to mount the device.



**CAUTION**  
**INSTALLATION CUT-OUT**

The mounting cutout must be located in a position that will not defeat the purpose of stabilizing webs or other reinforcing elements in the control panel. If necessary, reinforcing elements must be installed/added.

An IP65 degree of protection will only be ensured if there is sufficient stiffness and the device is properly mounted.

- Minimum sheet thickness of control panel where the device will be flush mounted:  
 $2 \text{ mm (0.08")} \leq d \leq 5 \text{ mm (0.2")}$

**List of tools:**

- 2.0 m Allen key
- PZ2 Pozidriv screwdriver
- Torque wrench with Newton meter scale

## 2. Installation

### 2.7 Preparations

### 2.7 Preparations

1. Select the installation location you want for the device.  
Make sure that all the requirements for the installation location are met → Page 28.
2. Make a cutout with the right size for the device at the location you selected.  
Make sure to observe all the criteria for the installation location.
3. Make sure that the mounting cutout has the right size.

#### Criteria for the Installation position

- The units can be installed in landscape or portrait mode.
- Do not install the device with the SD card slot facing downward.
- Material thickness of 2 mm (0.08")  $\leq d \leq$  5 mm (0.2") at the installation cutout and a flatness  $\square \leq$  0.5 mm (0.02") with a surface roughness  $\surd Rz \leq$  120; IP 65 → DIN ISO 2768-2 (K)
- The size of the installation cutout depends on the device type:  
XV-363-57-...:  $e = 198$  mm (7.79")  $\pm$  1 mm (0.04"),  $f = 142$  mm (5.59")  $\pm$  1 mm (0.04")  
XV-363-10-...:  $e = 329$  mm (12.95")  $\pm$  1 mm (0.04"),  $f = 238$  mm (9.37")  $\pm$  1 mm (0.04")  
XV-363-12-...:  $e = 344$  mm (13.54")  $\pm$  0.5 mm (0.02"),  $f = 262$  mm (10.31")  $\pm$  1 mm (0.04")

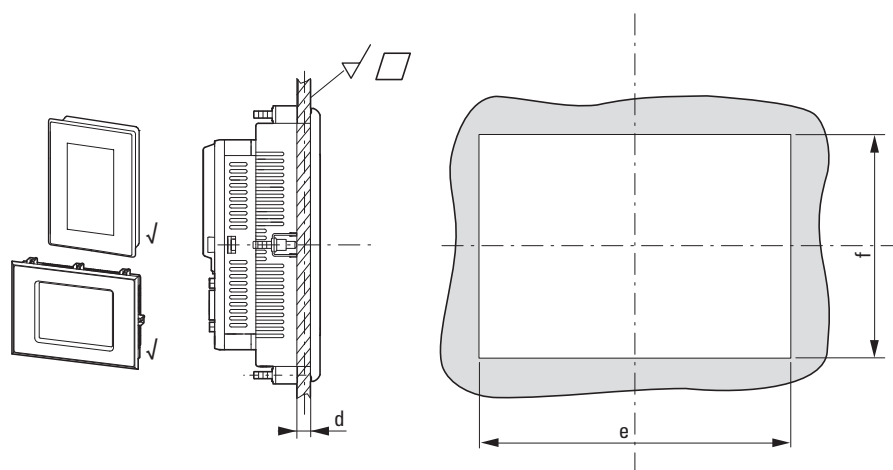

Fig. 6: flush mounted

4. Check the included gasket cord for damage.
5. Place the undamaged gasket cord inside the groove at the back of the device's bezel.
  - Start by placing one end of the gasket cord inside the groove at the bottom center
  - Without pulling, twisting, or stretching the gasket cord, insert the rest of it into the groove so that it goes all around the device



Make sure that both ends of the gasket cord  
– regardless of whether it is installed in landscape or portrait mode

- are on the bottom side of the device
- and not in the corners after installation.

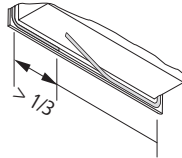

6. Cut the gasket cord diagonally in such a way that both ends will be tight against each other.
- Put the end of the gasket cord on top of the other end
  - Cut the end diagonally in such a way that there will be no gap between the two ends

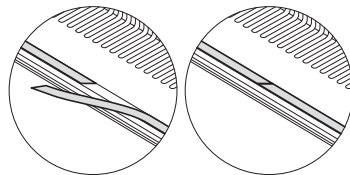

7. Place the end of the gasket cord inside the groove.



**CAUTION**  
**POOR SEALING**

If the gasket cord is twisted when placed inside the groove or does not provide adequate sealing all around, the degree of protection will not be achieved.

The join of the sealing strip must be positioned on the bottom of the device.

8. Check that the gasket is resting properly inside the groove and will provide the required sealing action

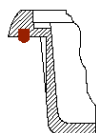

Fig. 7: Peripheral gasket at the back of the front frame on the display housing

## 2. Installation

### 2.7 Preparations

9. Pre-assemble the holding brackets with the set screws.  
Screw the Internal hexagon M 4 x 25 DIN 914 galvanized set screws into the holding brackets.

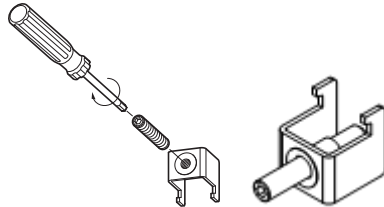

Fig. 8: Pre-installing the holding brackets

Eight holding brackets are included as accessories with the XV-363.

- ➔ For an IP65 degree of protection and for use in hazardous locations, all eight holding brackets need to be installed.
- ➔ Together with the gasket, the eight holding brackets are the main element required for achieving an IP65 (at front) degree of protection.

The purpose of the holding brackets is to secure the XV-363 in the installation cutout, e.g., on the control panel door.

To this end, the brackets must be hooked into the enclosure sideways and screwed against the control panel door, etc.

- ➔ The positions of the retaining brackets depend on:
  - The device type
  - The requirements for installation and for the required degree of protection

#### **Locations for the 4 holding brackets for an IP20 degree of protection**

- On the top and bottom sides of the device:  
One holding bracket each at the left and right outer fixing positions

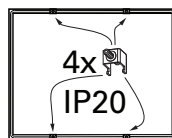

Fig. 9: Location of holding brackets for IP20 on XV-363-10-..

#### **Locations for eight holding brackets for an IP65 degree of protection and for devices used in hazardous locations**

XV-363-57-.. and XV-363-12-..

- On the top and bottom sides of the device:  
One holding bracket each at the left and right outer fixing positions, as well as at the center
- On the left and right sides of the device:  
One holding bracket each at the center fixing position

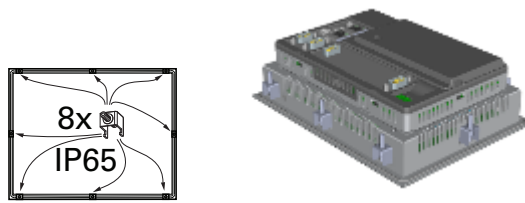

Fig. 10: Location of holding brackets for IP65 on XV-363-57-..

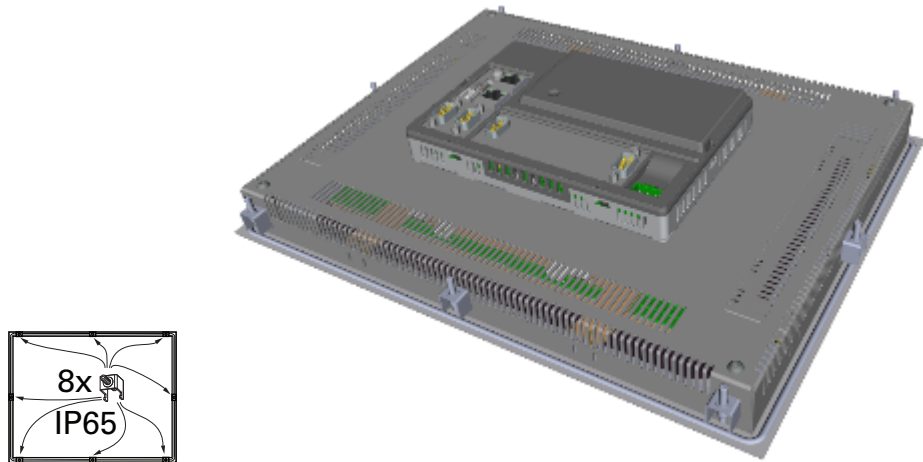

Fig. 11: Location of holding brackets for IP65 on XV-363-12-..

XV-363-10-..

- On the top and bottom sides of the device:  
One holding bracket each at the left and right fixing positions
- On the left and right sides of the device:  
One holding bracket each at the left and right fixing positions

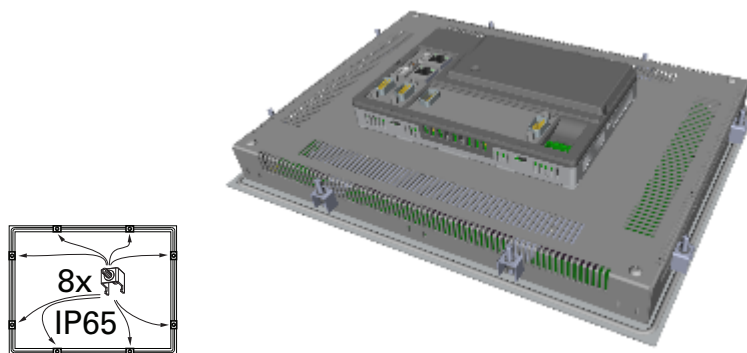

Fig. 12: Location of holding brackets for IP65 on XV-363-10-..

## 2. Installation

### 2.8 XV-363 mounting

### 2.8 XV-363 mounting

- ▶ 1. Insert the XV-363 into the mounting cutout from the front.

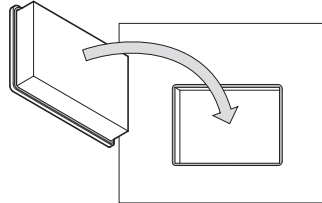

Fig. 13: Mounting in the installation cutout

- ▶ 2. As long as the device has not been secured with all holding brackets, make sure to secure it so that it will not fall down.
- ▶ 3. Insert the holding brackets into the first device cutout intended for this purpose.

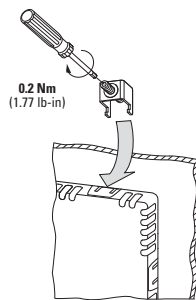

Fig. 14: Installing the holding brackets

- ▶ 4. Tighten the set screw until it comes into contact with the installation surface.
- ▶ 5. Follow steps 3 and 4 to insert the next holding bracket at a 90° angle to the last one you inserted.
- ▶ 6. Repeat steps 3 and 4 until all necessary holding brackets are installed.
- ▶ 7. Check that the device is in its correct, centered position and that the gasket is in contact all around; adjust if necessary
- ▶ 8. Tighten the set screws in a criss-cross sequence with a max. torque of  $\leq 0.2\text{Nm}$  (1.77 lb-in).

## 2.9 Preparing the device for operation



### **CAUTION INTERFERENCES**

Screw all plug-in connections or lock them into place in order to improve screening.

Signal cables must not be routed in the same cable duct with power cables.

Before putting the system into operation, check all cable connections to make sure that everything has been wired properly.

Make sure that all voltages and signals have the required values as per the specification.



### **CAUTION SHORT-CIRCUIT HAZARD**

If the Infra-red touch display is or has been exposed to environmental fluctuations (ambient temperature, air humidity), condensation may form on or inside it. As long as this condensation is present, there will be a short-circuit hazard.

Do not switch on the device when it has condensation in or on it.

If the Infra-red touch display has condensation in or on it, or if it has been exposed to environmental fluctuations, let the XV-363 settle into the existing ambient temperature before switching it on. Do not expose the device to direct thermal radiation from heating appliances.

### **Before connecting the power supply**



### **CAUTION**

24 VDC power supply for integrated AC-to-DC converter.

The voltage being applied must meet the requirements for safety extra-low voltages (SELV) set forth in IEC 60950 and the requirements for protected extra-low voltages (PELV) set forth in ICE/UL 61010-2-201.

Pay attention to the polarity.

### *NOTICE*

Arrange for an electrician to install the Plug connector MSTB 2.5/3-ST-5.08 and connect the power supply.

## 2. Installation

### 2.9 Preparing the device for operation

#### 2.9.1 Power supply - electrical connection

The XV360 Single Touch Display has an internal fuse and protection against polarity reversal.

The power supply for the XV360 Single Touch Display is not galvanically isolated.

The XV360 Single Touch Display requires a rated operating voltage of 24 VDC from an AC-to-DC converter with safe isolation (SELV/PELV).

Power Supply	
Rated operating voltage	+ 24 VDC SELV (safety extra low voltage)/PELV (protective extra low voltage)
Permissible voltage range	Effective: 19.2-30.0 V DC (rated operating voltage -20%/+25%)
	Absolute with ripple: 19.2-30.0 V DC
	Battery powered: 18.0-31.2 V DC (rated operating voltage -25%/+30%); 35 V DC for a duration of < 100 ms
Voltage dips	Ability to accommodate brief voltage dips $\leq 10$ ms from rated operating voltage (24 V DC), $\leq 5$ ms from undervoltage (19.2 V DC)
Power consumption	
XV-363-57-..	max. 19.5W Current consumption at 24 V DC: 17 W for basic device + 2.5 W for USB module
XV-363-10-..,	max. 20.5W Current consumption at 24 V DC: 18 W for basic device + 2.5 W for USB module
XV-363-12-..	max. 20.5W Current consumption at 24 V DC: 18 W for basic device + 2.5 W for USB module
Fuse	Yes (fuse not accessible)
Potential isolation	no

Electrical current	5.7" display	10.4" display	12.1" display
$I_e$	$\leq 1$ A	$\leq 1$ A	$\leq 1$ A
$I_{TH}$	2.5 A <sup>2</sup> s	3.0 A <sup>2</sup> s	3.0 A <sup>2</sup> s

Tab. 8: ConfigurationPlug connector MSTB 2.5/3-ST-5.08

signal	Configuration
+ 24VDC	Specifications for connection to supply voltage + 24 VDC SELV (safety extra low voltage)/PELV (protective extra low voltage)
	Functional earth, connected to the enclosure. Functional earthing is required for UL listing. If required due to the installation environment, this connection can be used as a protective earth connection.
0V	Supply voltage 0 V

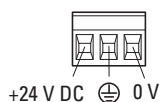

Tab. 9: Specifications for connection to 24 VDC supply voltage

Specifications for connection to 24 VDC supply voltage	
Copper conductor	60° / 70°C
Cross-section	min. 0.75 mm <sup>2</sup> / max. 2.5 mm <sup>2</sup> (drain wire or conductor)



## 2. Installation

### 2.9 Preparing the device for operation

Specifications for connection to 24 VDC supply voltage	
	min. AWG18 / max. AWG12
Tightening torque	0.6 ... 0.8 Nm (5 ... 7 lb-in) for the screws on the Plug connector MSTB 2.5/3-ST-5.08
Strip length	7 mm

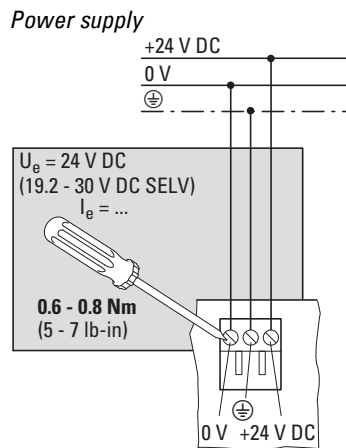

Fig. 15: Connecting the screw terminals on the Plug connector MSTB 2.5/3-ST-5.08

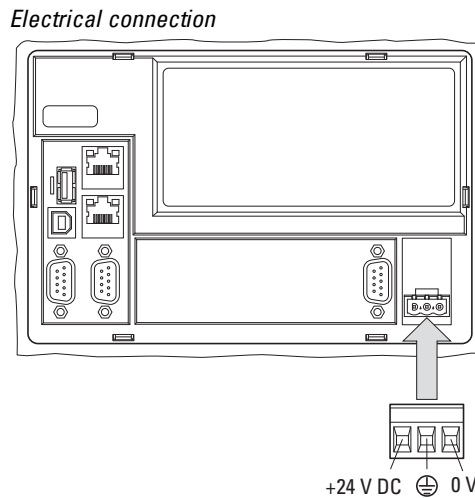

Fig. 16: Power supplied through Plug connector MSTB 2.5/3-ST-5.08

- ▶ Use the Plug connector MSTB 2.5/3-ST-5.08 to terminate the connection cable for the power supply in advance.
- ▶ Plug the pre-assembled plug into the socket on the enclosure.
- ▶ Pay attention to the polarity "+24V" and "0V".
- ▶ Connect the power supply cable to a 24 VDC supply voltage that meets the requirements for safety extra-low voltages (SELV) set forth in IEC 60950 and – in connection with the UL listing – the requirements for a low-voltage source set forth in UL 61010-2-201.

The XV360 Single Touch Display is now ready to run on 24 V<sub>DC</sub>.

## **2. Installation**

### **2.9 Preparing the device for operation**

## 3. Commissioning



**CAUTION**  
**SHORT-CIRCUIT HAZARD**

If the Infra-red touch display is or has been exposed to environmental fluctuations (ambient temperature, air humidity), condensation may form on or inside it. As long as this condensation is present, there will be a short-circuit hazard.

Do not switch on the device when it has condensation in or on it.

If the Infra-red touch display has condensation in or on it, or if it has been exposed to environmental fluctuations, let the XV-363 settle into the existing ambient temperature before switching it on. Do not expose the device to direct thermal radiation from heating appliances.

- ▶ Apply a XV-363 to the 24 VDC supply voltage unit

The XV-363 unit will boot up.



The XV-363 does not come with any runtime software for visualization or for use as an HMI installed.

In order to upgrade a unit to an HMI that can be used for control and operating purposes, use license product certificate LIC-PLC-A, part No. 181585.

The corresponding software packages can be used to install the required runtime software on the XV-363 unit.

### 3.1 Initial commissioning

Carry out the following steps once:

- ▶ Configure the XV-363 unit's system settings as necessary for your system.
- ▶ If necessary, install the required software packages.

### 3. Commissioning

#### 3.2 Running the XV-363

#### 3.2 Running the XV-363

Once the XV360 Single Touch Display has been initially commissioned, it will run whenever it is connected to the supply voltage.

In other words, it does not have to be separately switched on and off.



Reducing the level of brightness will increase the display backlight's lifespan.



Follow the instructions in the following section if your XV-363 until will not boot up and/or if an error message appears: → Section "Faults", page 61

#### See also



System description Windows CE 7

MN050004EN

### 4. External connections

With their ports, Eaton's XV-363 make it possible to connect a variety of peripheral devices and components.



#### **DANGER STRAY CURRENTS**

Large equalizing currents between the functional earthing system and the ground system of different devices may result in fire or in malfunctions due to signal interference.

- ▶ If necessary, route an equipotential bonding conductor, with a cross-sectional area that is several times larger than that of the cable shielding, parallel to the cable.



#### **CAUTION INTERFERENCES**

The values specified in the technical data, as well as the device's electromagnetic compatibility (EMC), cannot be guaranteed if the following are used: unsuitable cables, improperly assembled and terminated cables, and/or wiring that does not conform to the applicable standards. Only use cables assembled and terminated by professionals.

The cables being used must be assembled and terminated as required by the port/interface description in this document.

When wiring the XV-363, follow all instructions regarding how to wire the corresponding port/interface.

All general Directives and standards must be complied with.

## 4. External connections

### 4.1 Layout of interfaces

#### 4.1 Layout of interfaces

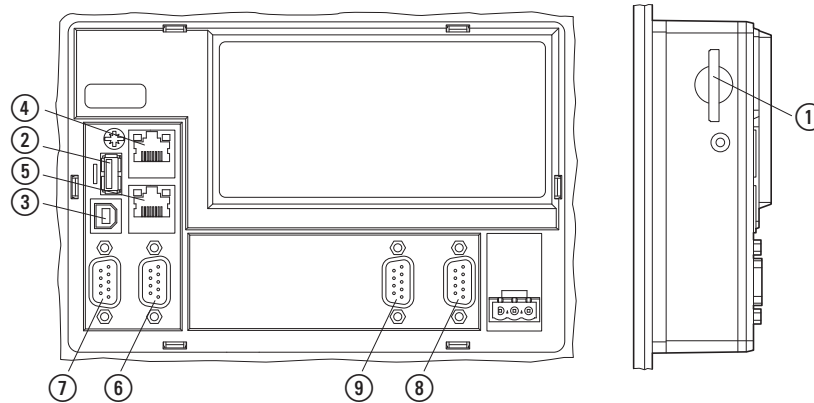

Fig. 17: Basic interfaces on all Human-machine interface units

	<b>Interface</b>	<b>Version</b>
①	SD card slot	SDSC or SDHC conforming to the SDA 2.0 specification
②	USB host	USB 2.0, not galvanically isolated, plug type A, Full power (500 mA)
③	USB device	USB 2.0, not galvanically isolated, plug type B
④	Ethernet 1	RJ-45 socket, 8-pole, 2 LEDs (CAT5e/6), LAN1, 10/100 Mbps
⑤	Ethernet 2	RJ-45 socket, 8-pole, 2 LEDs (CAT5e/6), LAN1, 10/100 Mbps
⑥	COM1	RS-232, not galvanically isolated, SUB-D plug 9-pole, UNC nuts for interlocking
⑦	COM2	RS-485, not galvanically isolated, SUB-D plug 9-pole, UNC nuts for interlocking
⑧	CAN	CAN1, not galvanically isolated, SUB-D plug 9-pole, UNC nuts for interlocking

#### Optional interfaces XV-363-...-C02-...-..

⑨	Profibus	Profibus DP, not galvanically isolated, SUB-D socket 9-pole, UNC nuts for interlocking
---	----------	--

## 4.2 SD card

The slot for the SD card is on the side of the XV-363 unit.



### **CAUTION DATA LOSS**

If the SD card is being written to and a voltage drop occurs or the card is removed, data may be lost or the SD card may be ruined.

▶ Insert the SD card only when the XV-363 is de-energized.

Observe the following if you are using the SD card to store data:

- SD cards have a limited number of write cycles.
  - If there is a voltage drop while a write operation is in progress, data loss is highly likely to occur.
- ▶ Remove the SD card only when the XV-363 is de-energized.
- ▶ Before switching off the device, make sure that there are no programs writing to the SD card.

### **Inserting the SD card**



SD cards cannot be inserted the wrong way around.  
Do not use force when inserting the card.

▶ Push the SD card into the SD card slot until you feel it lock into place.

### **Removing the SD card**

- ▶ Push the SD card into the SD card slot all the way to the stop.
- ▶ Pull the SD card out of the SD card slot.
- ▶ Store the SD card in its case in order to protect it.



Fig. 18: SD card inserted into slot but not yet locked in place

## 4. External connections

### 4.3 USB interfaces

### 4.3 USB interfaces

XV360 Single Touch Display units feature ports that can be used to connect USB peripheral devices supported by the XV-363 unit's hardware and operating system.



#### CAUTION

When using commercially available peripheral devices (e.g., with the USB port), it is important to keep in mind that their EMC interference immunity parameters may render them unsuitable for use in industrial environments.

The USB ports (USB host and USB device) on the XV-363 are intended exclusively for maintenance work.



Only use standard USB cables with a shield.  
Max. cable length: 5 m.

#### 4.3.1 USB host



Fig. 19: USB 2.0, not galvanically isolated, plug type A, Full power (500 mA)

#### 4.3.2 USB device

The USB device interface supports USB 2.0.



Fig. 20: USB 2.0, not galvanically isolated, plug type B



## 4.4 Ethernet 1, Ethernet 2

The Ethernet 1 port on the XV-363 can be used as a communication interface or as a real-time field bus interface.

The Ethernet 2 port on the XV360 Single Touch Display can only be used as a communication interface without real-time requirements.

The Ethernet controllers support transfer rates of 10 Mbit/s and 100 Mbit/s.

When the green LED lights up, this means that there is a LINK, i.e., that an active network is connected and has been detected. When the yellow LED flashes, this means that data is being transferred.



Fig. 21: RJ-45 socket, 8-pole, 2 LEDs (CAT5e/6), LAN1, 10/100 Mbps



For the network, use shielded twisted-pair (STP) cables only.

For connecting:

The XV-363 to a device:

- Use a crossover cable.

The XV-363 to a hub/switch:

- Use a patch cable (1:1).

Max. cable length: 100 m.



### CAUTION

#### FORCES ON THE ETHERNET INTERFACE

Communications may be affected, and the connection's mechanical components may be damaged, if the Ethernet interface is subjected to strong vibrations or the RJ45 plug-in connection is subjected to pulling.

- Protect the RJ45 plug-in connection from strong vibrations.
- Protect the RJ45 plug-in connection from tensile forces at the socket.

To commission the communication between the XV-363 and the device, follow the description for the connected device.

Eaton recommends implementing measures for protecting against cyberattacks.



Eaton cyber security

<https://www.eaton.com/us/en-us/company/news-insights/cybersecurity.html>



<https://www.eaton.com/cybersecurity>

## 4. External connections

### 4.5 Serial interfaces for communication with PLCs or devices

## 4.5 Serial interfaces for communication with PLCs or devices

### 4.5.1 COM1 RS-232

The RS232-The interface is not electrically isolated.



#### CAUTION

#### NON-GALVANICALLY-ISOLATED INTERFACES

The XV-363 may be damaged by potential differences.

- ▶ The GND terminals of all bus modules must be connected.
- ▶ Do not connect the connector to the XV-363 or disconnect it without first de-energizing the system.

Tab. 10: Pin assignment COM1 RS-232, not galvanically isolated, SUB-D plug 9-pole, UNC nuts for interlocking

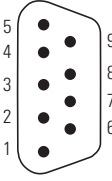
<b>SUB-D plug</b>		<b>PIN</b>	<b>signal</b>	<b>Description</b>
9 pole 	1	1	DCD	Data Carrier Detect
	2	2	RXD	Receive Data
	3	3	TXD	Transmit Data
	4	4	DTR	Data Terminal Ready
	5	5	GND	Signal Ground
	6	6	DSR	Data Set Ready
	7	7	RTS	Request to Send
	8	8	CTS	Clear To Send
	9	9	RI	Ring Indicator
Plug housings			GND	Functional earth

## 4. External connections

### 4.5 Serial interfaces for communication with PLCs or devices

#### 4.5.1.1 Wiring topic

- Shielded cables must be used.
- The maximal baud rate depends on the cable length

Tab. 11: RS-232 cable length based on baud rate

Cable length	Max. baud rate
2,5 m	115200 Bit/s
5 m	57600 Bit/s
10 m	38400 Bit/s
15 m	19200 Bit/s
30 m	9600 Bit/s



When preparing connections, ensure that the cable shield has a low impedance connection with the connector housing.

## 4. External connections

### 4.5 Serial interfaces for communication with PLCs or devices

#### 4.5.2 COM2 RS-485

The RS485-The interface is not electrically isolated.



#### CAUTION

#### NON-GALVANICALLY-ISOLATED INTERFACES

The XV-363 may be damaged by potential differences.

- ▶ The GND terminals of all bus modules must be connected.
- ▶ Do not connect the connector to the XV-363 or disconnect it without first de-energizing the system.

Tab. 12: Pin assignment COM2 RS-485, not galvanically isolated, SUB-D plug 9-pole, UNC nuts for interlocking

SUB-D plug	PIN	signal	Description
9 pole 	1	n.c.	not used
	2	n.c.	not used
	3	B	Line B
	4	n.c.	not used
	5	GND	Ground
	6	5 V	Output for external bus termination
	7	A	A cable
	8	n.c.	not used
	9	n.c.	not used
Plug housings	GND	Functional earth	



n.c.: PIN 1, 2, 4, 8 and 9 must not be connected.



Pin 6 (5 V) must not be used as a power supply for external devices.

#### 4.5.2.1 Wiring topic

- Screened twisted-pair cables must be used.
- The maximal baud rate depends on the cable length.

Tab. 13: Specifications for RS-485 wiring

Rated cable impedance	120 Ohm
Permissible impedance	108 ... 132 Ohm
Max. cable length	1200 m
Possible baud rates	9600 Bit/s
	19200 Bit/s
	38400 Bit/s
	57600 Bit/s
	115200 Bit/s



When preparing connections, ensure that the cable shield has a low impedance connection with the connector housing.

## 4. External connections

### 4.5 Serial interfaces for communication with PLCs or devices

#### 4.5.2.2 RS-485 topology

- A bus segment can interconnect up to 32 slaves.
- Several bus segments can be connected using repeaters (bi-directional amplifiers).



The use of repeaters enables the maximum cable length to be increased.

For more details, please consult the documentation provided by manufacturer.

A bus segment must be provided with cable termination (120 Ohm) at both ends.

These terminals must be connected in the plug directly between pin 3 and 7.



The bus segment must be terminated at both ends.

There must not be more than two terminations per bus segment.

Running the bus segment without the right termination may result in transmission errors.

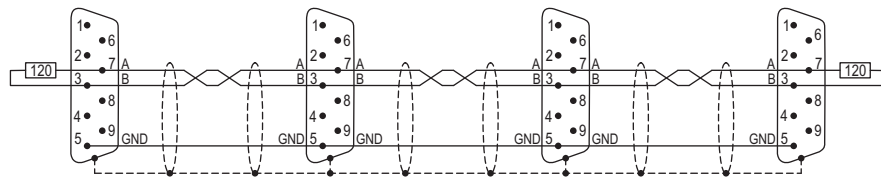

Fig. 22: Bus segment with four nodes

## 4. External connections

### 4.6 CAN1 interface for the CANopen protocol, J1939 protocol, etc.

#### 4.6 CAN1 interface for the CANopen protocol, J1939 protocol, etc.

The CAN1-The interface is not electrically isolated.



#### CAUTION

#### NON-GALVANICALLY-ISOLATED INTERFACES

The XV-363 may be damaged by potential differences.

- ▶ The GND terminals of all bus modules must be connected.
- ▶ Do not connect the connector to the XV-363 or disconnect it without first de-energizing the system.

Tab. 14: PIN assignment for CAN interface as specified in CiA) CAN1, not galvanically isolated, SUB-D plug 9-pole, UNC nuts for interlocking

SUB-D plug	PIN	signal	Description
9 pole 	1	n.c.	not used
	2	CAN-L	Bus line (dominant low)
	3	GND	Ground
	4	n.c.	not used
	5	n.c.	not used
	6	GND	Optional Ground
	7	CAN-H	Bus line (dominant high)
	8	n.c.	not used
	9	n.c.	not used



- nc: PIN 1, 4, 5, 8 and 9 must not be connected.
- PIN 3 (CAN-GND) and 6 (GND) are internally inter-connected.
- The power supply of the CAN bus drivers is implemented internally.
- A power supply for third party devices is not provided on the CAN connector.

## 4. External connections

### 4.6 CAN1 interface for the CANopen protocol, J1939 protocol, etc.

#### 4.6.0.1 Wiring topic

- Screened twisted-pair cables must be used.

Tab. 15: Specifications for CAN wiring

Rated cable impedance			120 Ohm
Permissible impedance			108 ... 132 Ohm
Capacitance per unit length			< 60 pF/m
Core cross-section	With a max. cable length of	100 m	0.25 mm <sup>2</sup>
		250 m	0.34 mm <sup>2</sup>
		500 m	0.75 mm <sup>2</sup>

## 4. External connections

### 4.6 CAN1 interface for the CANopen protocol, J1939 protocol, etc.

The maximal baud rate depends on the cable length.

Possible baud rates	With a max. cable length of		
		25 m	1000 kBit/s (= default settings)
		50 m	800 kBit/s (= default settings)
		100 m	500 kBit/s (= default settings)
		250 m	250 kBit/s (= default settings)
		500 m	125 kBit/s (= default settings)
		500 m	100 kBit/s (can be set through software)
		1000 m	50 kBit/s (= default settings)
		2500 m	20 kBit/s (= default settings)
		5000 m	10 kBit/s (= default settings)



When preparing connections, ensure that the cable shield has a low impedance connection with the connector housing.



4.6 CAN1 interface for the CANopen protocol, J1939 protocol, etc.

4.6.0.2 CAN-Bus-topology

- A bus segment can interconnect up to 32 slaves.
- Several bus segments can be connected using repeaters (bi-directional amplifiers).



The use of repeaters enables the maximum cable length to be increased.

Repeaters can also be used for galvanic isolation. For more details, please consult the documentation for repeaters provided by manufacturer.

Make sure to follow the recommendations provided by CiA (CAN in Automation)

at <http://www.can-cia.org>.

A bus segment must be provided with cable termination (120 Ohm) at both ends.

These terminals must be connected in the plug directly between pin 2 and 7.



The bus segment must be terminated at both ends.

There must not be more than two terminations per bus segment.

Running the bus segment without the right termination may result in transmission errors.

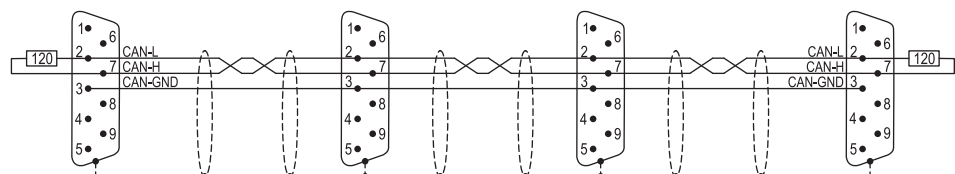

Fig. 23: CAN bus segment with four nodes

## 4. External connections

### 4.7 Profibus Interfaces

#### 4.7 Profibus Interfaces

The Profibus-DP--The interface is not electrically isolated.



#### CAUTION

#### NON-GALVANICALLY-ISOLATED INTERFACES

The XV-363 may be damaged by potential differences.

- ▶ The GND terminals of all bus modules must be connected.
- ▶ Do not connect the connector to the XV-363 or disconnect it without first de-energizing the system.

Tab. 16: Pin assignment for Profibus DP, not galvanically isolated, SUB-D socket 9-pole, UNC nuts for interlocking PROFIBUS interface

SUB-D socket	PIN	signal	Description
9 pole 	1	n.c.	not used
	2	n.c.	not used
	3	B	EIA RS 485 cable B
	4	RTSAS	Output for controlling a repeater
	5	M5EXT (GND)	Output 0 V for external termination (Ground)
	6	P5EXT	Output 5 V for external termination
	7	n.c.	not used
	8	A	EIA RS 485 cable A
	9	n.c.	not used



PIN 6 (5 V) must not be used as a power supply for external devices.  
nc: PIN 1, 2, 7 and 9 must not be connected.

**4.7.0.1 Wiring topic**

- Screened twisted-pair cables must be used.
- Cable type A (as specified in Profibus standards IEC/EN 61158 and IEC/EN 61784)

Tab. 17: Specifications for Profibus wiring

Cable specifications			
Rated cable impedance			150 Ohm
Permissible impedance			135 ... 165 Ohm
Capacitance per unit length			< 30 pF/m
Loop resistance			< 100 Ohm/km
Core cross-section			≥ 0.34 mm <sup>2</sup> (22 AWG)
The maximal baud rate depends on the cable length.			
Possible baud rates	With a max. cable length of	100 m	12000 kBit/s (12MBit/s)
		200 m	1500 kBit/s (= default settings)
		400 m	500 kBit/s (= default settings)
		1000 m	187.5 kBit/s (= default settings)
		1200 m	≤ 93.75 kBit/s



When preparing connections, ensure that the cable shield has a low impedance connection with the connector housing.

## 4. External connections

### 4.7 Profibus Interfaces

#### 4.7.0.2 Profibus topology

- A bus segment can interconnect up to 32 slaves.
- Several bus segments can be connected using repeaters (bi-directional amplifiers).



The use of repeaters enables the maximum cable length to be increased.

For more details, please consult the documentation for repeaters provided by manufacturer.

Only use bus connector plugs specified for use with PROFIBUS networks.

These plugs combine both bus cables on a single node and ensure that the cable shield has a low-impedance connection to the node's shield reference potential.

These bus terminal connectors contain the PROFIBUS cable termination that can be switched on as required.

A bus segment must be provided with cable termination at both ends. This termination is passive, but is fed from the node. It ensures a defined quiescent signal on the bus if no bus station is sending. These bus terminations are preferably implemented externally in the connector housing as per the PROFIBUS standard (and can be implemented using the aforementioned bus connector plugs).

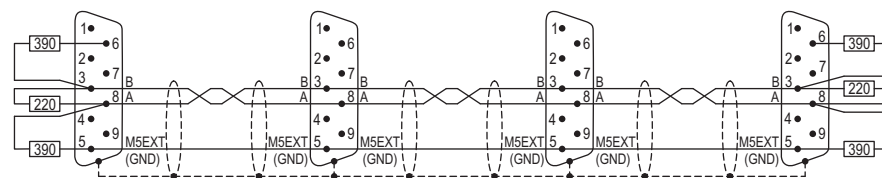

Fig. 24: Profibus bus segment with four nodes



- The bus segment must be terminated at both ends.
- No more than two terminations must be provided for each bus segment.
- At least one of the two terminations must be fed by the bus station.
- Operation without correct termination of the Profibus network can cause transfer errors.

## 5. Faults

This section provides troubleshooting information for your XV360 Single Touch Display in case it does not behave as expected.

<b>Fault</b>	<b>Cause</b>	<b>Remedy</b>
XV-363 will not boot up	No 24 VDC supply voltage	Check the input wiring. Switch on XV-363
The display stays or turns dark.	The backlight is deactivated.	Switch the backlight on; please refer to the Windows Embedded Compact 7 pro system description or to the corresponding function in the visualization software.
The Infra-red single touch is not responding or is responding incorrectly when used.	The infrared touchscreen display's infrared frame is soiled	Clean the infrared frame
	The set screws are too tight	Loosen the set screws; see Mounting → Page 38
	The touch is disabled.	Switch on XV-363. Enable the touch functionality; please refer to the Windows Embedded Compact 7 pro system description

## 5. Faults

## 6. Maintenance

### 6.1 Cleaning and maintenance

#### 6.1.1 Cleaning the infrared touchscreen

The infrared frame needs to be cleaned on a regular basis.



If the infrared frame is heavily soiled, the infrared channels may be disrupted. In extreme cases, this will result in the corresponding touch zones no longer responding.



#### **CAUTION**

#### **POINTY, SHARP OBJECTS AND CORROSIVE LIQUIDS**

When cleaning the Infra-red touch display:

- Do not use any pointy or sharp objects (e.g., knives).
- Do not use aggressive or abrasive cleaning products or solvents.

Make sure that no liquids get into the device (short-circuit hazard) and that the XV-363 is not damaged in any way.

- ▶ Clean the infrared frame and the display with a clean, soft, damp cloth.

#### 6.1.2 Battery

The internal battery used to back up the real-time clock is maintenance-free and is sized for a backup time of normally 10 years at 25° C (77°F) when de-energized, provided the corresponding ambient conditions are met.

## 6. Maintenance

### 6.2 Repairs

### 6.2 Repairs

For repairs, please contact your vendor or Eaton's Technical Support.



**CAUTION  
DESTRUCTION**

The XV-363 should only be opened by the manufacturer or by an authorized center. Operate the Infra-red touch display until only with the enclosure fully closed and sealed.

Use the original packaging to ship the device.



## 6.3 Storage, transport and disposal

### 6.3.1 Storage and transport



**CAUTION  
UV LIGHT**

Plastics will become brittle when exposed to UV light. This artificial aging will reduce the XV-363 unit's lifespan. Sunrays will disrupt the infrared touch sensor.

Protect the Infra-red touch display unit from direct sunlight and other sources of UV radiation.



**CAUTION  
SHORT-CIRCUIT HAZARD**

If the Infra-red touch display is or has been exposed to environmental fluctuations (ambient temperature, air humidity), condensation may form on or inside it. As long as this condensation is present, there will be a short-circuit hazard.

Do not switch on the device when it has condensation in or on it.

If the Infra-red touch display has condensation in or on it, or if it has been exposed to environmental fluctuations, let the XV-363 settle into the existing ambient temperature before switching it on. Do not expose the device to direct thermal radiation from heating appliances.

The ambient conditions must be met when transporting and storing the XV-363.

The ambient air temperature for storage and transportation must not exceed the maximum specified limit:  $-20 - +60$  °C ( $-4 - +140$  °F)



Before commissioning

If storing/transporting the device in cold weather conditions or in such a way that it will be exposed to extreme differences in temperature, make sure that no condensation forms on or inside the device.

If there is condensation in or on the device, do not switch on the device until it is completely dry.

Use the original packaging to ship the device.

The Infra-red touch display is sturdily built, but the components inside it are sensitive to excessively strong vibrations and/or mechanical shock.

Accordingly, make sure to protect the XV-363 from mechanical loads that exceed the scope of the unit's intended use.

## 6. Maintenance

### 6.3 Storage, transport and disposal

The device should only be transported in its original packaging after being packed properly.

#### 6.3.2 Disposal

	<p><b>EXPLOSION HAZARD</b> <b>LITHIUM BATTERY</b></p> <p>The lithium battery inside the XV-363 may explode if handled incorrectly.</p>
---	--

	<p><b>Important!</b></p> <p>Dispose of recyclables as required by your local recycling regulations.</p>
---	---

XV-363 no longer being used must be professionally disposed or returned to the manufacturer or relevant sales department.

►  Dispose of the Infra-red touch display unit professionally.

Tab. 18: Materials used XV360 Single Touch Display

Assembly part	Material
Display	Laminated safety glass, non-reflective, in aluminum bezel
Back of the housing.	
Display	Metal
CPU/interfaces	Insulated material black
Battery	Lithium BR-2330/GNU, 3V, 255 mAh, Weight (g): 3.7 SVHC Substance 1.2-dimethoxyethane: ethylene glycol dimethyl ether (EGDME) Substance weight (%): 2-4

#### Materials used in the packaging

Packaging	Material
Outer packaging	Cardboard
Inner packaging XV-363-57-..	Closed cell polyethylene foam, free of CFCs / plastic bag: polyethylene (PE)
Inner packaging XV-363-10-.. and XV-363-12-..	Cardboard Plastic film and bag: Polyethylene (PE)

## Appendix

---

<a href="#">A.1 Technical data</a> .....	<b>68</b>
A.1.1 Data sheets .....	68
A.1.2 Dimension and weight specifications .....	69
A.1.3 General data .....	73
A.1.4 Port and interface specifications .....	75
A.1.5 Information on the power supply .....	76
A.1.6 Approvals and declarations .....	77
<a href="#">A.2 Further reading</a> .....	<b>78</b>

## Appendix

### A.1 Technical data

## A.1 Technical data

### A.1.1 Data sheets

The current specifications for the device can be found in the corresponding data sheet at [www.eaton.eu/ecat](http://www.eaton.eu/ecat)

Article no. and type	Description
<a href="#">197664 - XV-363-57-C00-A00-1B</a>	User interface 5.7-inch display, 24VDC, IR, 640 x 480 pixels, 2xEthernet,1xRS232,1xRS485,1xCAN, PLC function can be added
<a href="#">197665 - XV-363-10-C00-A00-1B</a>	User interface 10.4-inch display, 24VDC, IR, 640 x 480 pixels, 2xEthernet,1xRS232,1xRS485,1xCAN, PLC function can be added
<a href="#">197666 - XV-363-12-C00-A00-1B</a>	User interface 12.1-inch display, 24VDC, IR, 800 x 600 pixels, 2xEthernet,1xRS232,1xRS485,1xCAN, PLC function can be added
<a href="#">197667 - XV-363-57-C02-A00-1B</a>	User interface 5.7-inch display, 24VDC, IR, 640 x 480 pixels, 2xEthernet,1xRS232,1xRS485,1xCAN, 1xDP, PLC function can be added
<a href="#">197668 - XV-363-10-C02-A00-1B</a>	User interface 10.4-inch display, 24VDC, IR, 640 x 480 pixels, 2xEthernet,1xRS232,1xRS485,1xCAN, 1xDP, PLC function can be added
<a href="#">197669 - XV-363-12-C02-A00-1B</a>	User interface 12.1-inch display, 24VDC, IR, 800 x 600 pixels, 2xEthernet,1xRS232,1xRS485,1xCAN, 1xDP, PLC function can be added

**A.1.2 Dimension and weight specifications**

**A.1.2.1 XV-363-57-..**

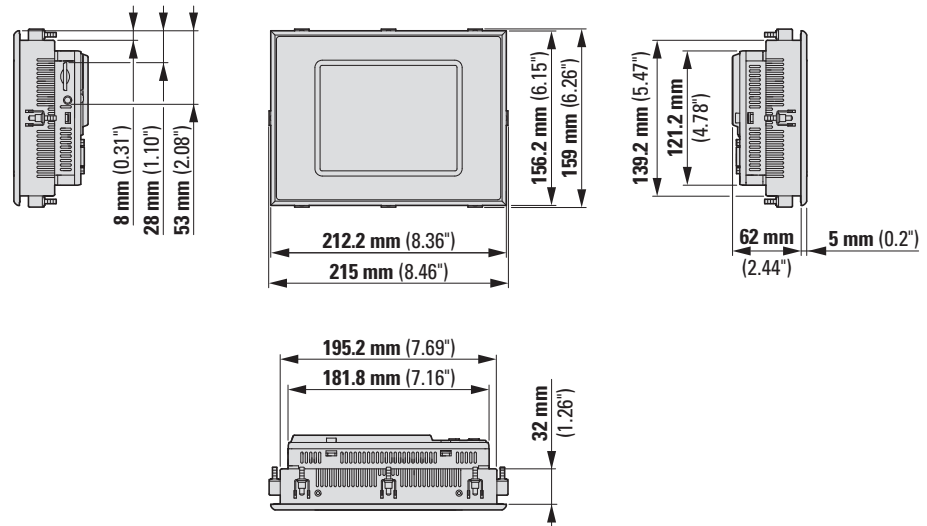

Fig. 25: Dimensions for 5.7" front mounting devices in mm (inches)

Width x Height x Depth (without plug)	212.2 mm x 156.2 mm x 67.0 mm (8.36" x 6.15" x 2.46")
Weight	1.8 kg (3.96 lbs)

## Appendix A.1 Technical data

### A.1.2.2 XV-363-10-..

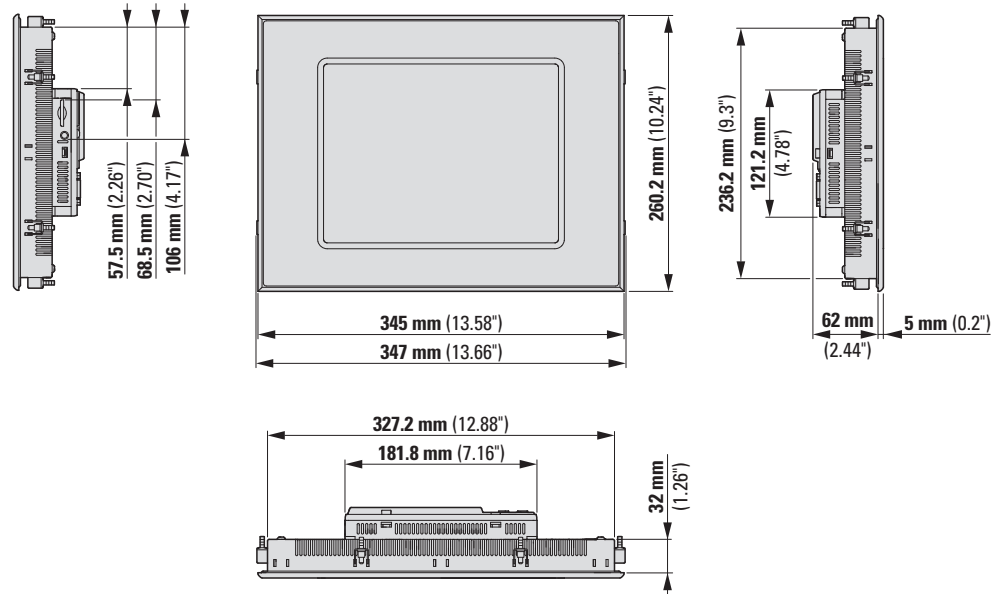

Fig. 26: Dimensions for 10.4" front mounting devices in mm (inches)

Width x Height x Depth (without plug)	345.2 mm x 260.2 mm x 67.0 mm (13.58" x 10.23" x 2.46")
Weight	3.4 kg (7.49 lbs)

**A.1.2.3 XV-363-12-..**

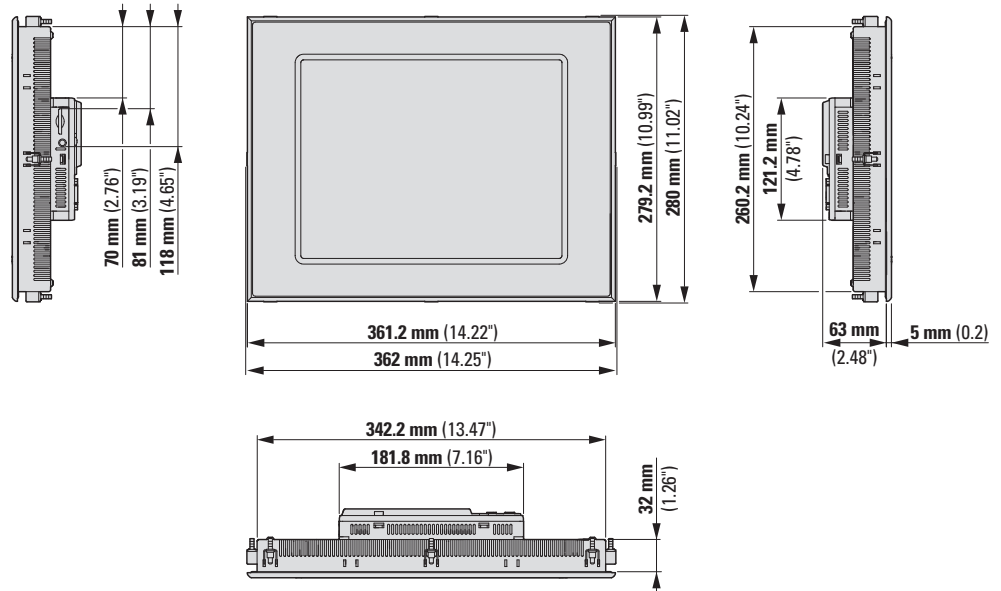
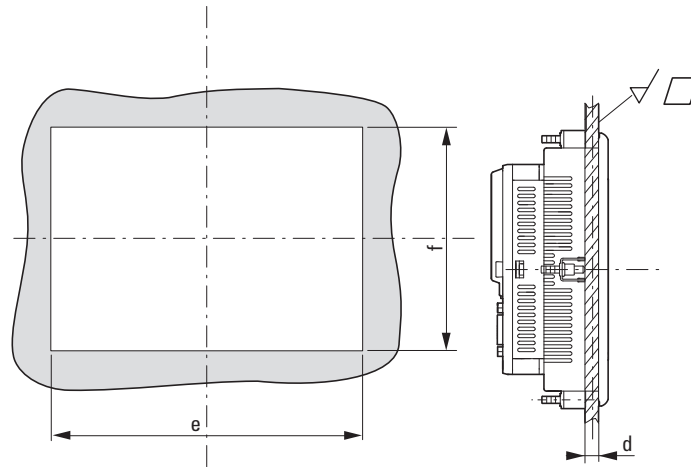

Fig. 27: Dimensions for 12.1" front mounting devices in mm (inches)

Width x Height x Depth (without plug)	361.2 mm x 279.2 mm x 67.9 mm (14.22" x 10.99" x 2.50")
Weight	3.8 kg (8.37 lbs)

## Appendix A.1 Technical data

### A.1.2.4 Hole diameter built-in



- Material thickness of  $2 \text{ mm (0.08")} \leq d \leq 5 \text{ mm (0.2")}$  at the installation cutout and a flatness  $\square \leq 0.5 \text{ mm (0.02")}$  with a surface roughness  $\nabla Rz \leq 120$ ; IP 65  $\rightarrow$  DIN ISO 2768-2 (K)
- The size of the installation cutout depends on the device type:
  - XV-363-57-...:  $e = 198 \text{ mm (7.79")} \pm 1 \text{ mm (0.04")}$ ,  $f = 142 \text{ mm (5.59")} \pm 1 \text{ mm (0.04")}$
  - XV-363-10-...:  $e = 329 \text{ mm (12.95")} \pm 1 \text{ mm (0.04")}$ ,  $f = 238 \text{ mm (9.37")} \pm 1 \text{ mm (0.04")}$
  - XV-363-12-...:  $e = 344 \text{ mm (13.54")} \pm 0.5 \text{ mm (0.02")}$ ,  $f = 262 \text{ mm (10.31")} \pm 1 \text{ mm (0.04")}$



**A.1.3 General data**

The following specifications apply to all XV360 Single Touch Display units or to the specified part nos. where applicable.

<b>General</b>	
Body material	Insulated material black
Front type	Laminated safety glass, non-reflective, in aluminum bezel
Degree of protection	IP65 (at front), IP20 (at rear)
<b>Operation</b>	
Technology	Infra-red single touch
Operating System	Windows Embedded Compact 7 pro
Processor	ARM Cortex-A9 800 MHz
Internal memory	DRAM: 512 MB RAM, flash memory: 1 GB SLC, NVRAM: 128 kB Retain
SD card slots	One SDSC or SDHC conforming to the SDA 2.0 specification – use genuine accessories only!
Cooling	Fanless CPU and system cooling, natural convection-based passive cooling
<b>Back-up of real-time clock</b>	
Battery (lifespan)	Non-maintained
Backup (time at zero voltage)	normally 10 years at 25° C (77°F)

## Appendix

### A.1 Technical data

<b>Display</b>	
Display - Type	Color display, TFT
Number of Colors	65536 colors
Resolution	
XV-363-57-..	VGA 640 px x 480 px
XV-363-10-..	
XV-363-12-..	SVGA 800 px x 600 px
Screen diagonal	Format 4:3
XV-363-57-..	Display size 5.7"
XV-363-10-..	Display size 10.4"
XV-363-12-..	Display size 12.1"
Screen area visible	
XV-363-57-..	115 mm x 86 mm
XV-363-10-..	211 mm x 158 mm
XV-363-12-..	246 mm x 185 mm
Contrast ratio (Normally)	normally 500:1
Brightness	Normally 400 cd/m2
Backlight	LED dimnable via software
Lifespan of backlight	Normally 50000 h at 25 °C
<b>Ambient climatic conditions</b>	
Air pressure (in operation)	795 - 1080 hPa Max. 2000 m above sea level
Temperature	
Operation	± 0 – +50 °C (+32 – +122 °F)
Storage / Transport	-20 – + 60 °C (-4 – +140 °F)
Humidity	Relative humidity 10 - 95 %
Condensation	non-condensing

**A.1.4 Port and interface specifications**

Tab. 19: Interfaces, communication

Catalog Number	XV-3.3-..-C00-...-..	XV-363-...-C02-...-..
Qty.		
Ethernet	2	2
RS-232	1	1
RS-485	1	1
CAN	1	1
USB host 2.0	1	1
USB device 2.0	1	1
Profibus	–	1
Type		
Ethernet	10/100 Mbps	
USB Host	USB 2.0, not galvanically isolated	
1 x USB device,	USB 2.0, not galvanically isolated	
RS-232	not galvanically isolated, SUB-D plug, 9-pole, UNC	
RS-485	not galvanically isolated, SUB-D plug, 9-pole, UNC	
CAN	not galvanically isolated, SUB-D plug, 9-pole, UNC	
Profibus DP	–	not galvanically isolated, D-Sub bus 9-pole, UNC

## Appendix

### A.1 Technical data

#### A.1.5 Information on the power supply

The following specifications apply to all XV360 Single Touch Display units.

<b>Power Supply</b>	
Rated operating voltage	+ 24 VDC SELV (safety extra low voltage)/PELV (protective extra low voltage)
Permissible voltage range	Effective: 19.2-30.0 V DC (rated operating voltage -20%/+25%)
	Absolute with ripple: 19.2-30.0 V DC
	Battery powered: 18.0-31.2 V DC (rated operating voltage -25%/+30%); 35 V DC for a duration of < 100 ms
Voltage dips	Ability to accommodate brief voltage dips $\leq 10$ ms from rated operating voltage (24 V DC), $\leq 5$ ms from undervoltage (19.2 V DC)
Power consumption	
XV-363-57-..	max. 19.5W Current consumption at 24 V DC: 17 W for basic device + 2.5 W for USB module
XV-363-10-..	max. 20.5W Current consumption at 24 V DC: 18 W for basic device + 2.5 W for USB module
XV-363-12-..	max. 20.5W Current consumption at 24 V DC: 18 W for basic device + 2.5 W for USB module
Fuse	Yes (fuse not accessible)
Potential isolation	no

Electrical current	5.7" display	10.4" display	12.1" display
$I_e$	$\leq 1$ A	$\leq 1$ A	$\leq 1$ A
$I_{TH}$	2.5 A <sup>2</sup> s	3.0 A <sup>2</sup> s	3.0 A <sup>2</sup> s

### A.1.6 Approvals and declarations

The following specifications apply to all XV360 Single Touch Display units.

<b>Approvals and declarations</b>		
CE	XV-363 units comply with all applicable European Union (EU) Directives and feature the CE marking.	
Explosion safety	II 3D Ex tc IIIC T70°C IP6x: Zone 22, Category 3D <ul style="list-style-type: none"> <li>• IP5x for group IIIB devices (nonconductive dust)</li> <li>• IP6x for group IIIC devices (conductive dust)</li> </ul> Fixing material that must be installed as specified without fail for front mounting: - Eight Holding bracket with set screw, - Cord gasket gasket	
<b>Applied standards and directives</b>		
EMC (relevant for CE)	2014/30/EU	
	IEC/EN 61000-6-2	Interference immunity for industrial environments
	IEC/EN 61000-6-4	Emitted interference for industrial environments
Explosion protection (relevant for CE)	ATEX directive 94/9/EG 2014/34/EG	
	IEC/EN 60079-0	Explosive atmospheres: Equipment - General requirements
	IEC/EN 60079-31	Explosive atmospheres: Equipment dust ignition protection by enclosure "t"
Security	IEC/EN 60950	Safety of Information Technology Equipment
	DIN EN 60529	Degrees of protection provided by enclosures
Product standards	DIN EN 60898-1:2006-03	Electrical accessories - Circuit-breakers for overcurrent protection for household and similar installations
	EN 50178_x	Electronic equipment for use in power installations
	IEC/EN 61131-2	Programmable controllers: Equipment requirements and tests
Mechanical shock resistance	IEC/EN 60068-2-27	15g /11ms
Vibration	IEC/EN 60068-2-6	Displacement amplitude: 5–9 Hz: 3.5 mm; 9–60 Hz: 0.15 mm Acceleration amplitude: 60–150 Hz: 2 g
Free fall, packaged	IEC/EN 60068-2-31	
RoHS	Directive 2011/65/EG	conform
Climatic proofing	Cold to IEC 60068-2-1	
	Damp heat as per EN 60068-2-3	
	Dry heat to IEC60068-2-2	

## Appendix A.2 Further reading

### A.2 Further reading

#### Hardware

For more information on additional devices and modules, please refer to the following documentation:

 Installation instructions IL048014ZU  
XV-363-57-..., XV-363-10-..., XV-363-12-..

#### Software



For more information, please refer to the following manuals:

 GALILEO 10 mn048018en  
 System description Windows CE 7 MN050004EN

#### Communication

Human-machine interfaces are able to communicate with a variety of PLCs. In order to integrate your XV-363 into your system, additional settings will need to be configured as appropriate for the PLC being used.

The following documents, together with other documentation, explain what needs to be taken into account and configured:

 Networks in Brief MN05010009Z  
 XSOFT-CODESYS 2, MN048015ZU  
XV300 PLC programming user manual  
 XSOFT-CODESYS 3, MN048008ZU  
PLC programming user manual

#### Download Center, Eaton Online Catalog

Enter "XV-363" into the search box and the catalog will take you directly to the corresponding product group in the Automation, Control and visualization section.

 <http://www.eaton.eu/doc>

 <http://www.eaton.eu/ecat>

#### Product information

For up-to-date information, please consult the product page on the Internet.

 <http://www.eaton.eu/xv300>

## Alphabetical index

### A

Accessory devices .....	19
Aeration and de-aeration .....	31
Ambient climatic conditions .....	30, 74
Approvals .....	77

### B

Basic equipment .....	13
Battery .....	63
Body material .....	73
Brand names	
Product names .....	2
Break-Down Service .....	2

### C

CAN .....	17, 46
CAN1 .....	54
CANopen .....	54
Cleaning .....	63
COM1 .....	17, 46
COM2 .....	17, 46
Commissioning .....	43
Company information .....	2
Connections	
External .....	45
Cooling .....	73
Copy-protected .....	2
Copyright .....	2
CTRL button .....	16
Current .....	40, 76

### D

Damage .....	32
Declarations .....	77
Degree of protection .....	73
Description .....	13
Device variants .....	14
Dimensions .....	69
Directives .....	77
Display .....	16, 74
Disposal	
Recycling .....	66
Download Center .....	78

### E

Eaton Safety instructions .....	I
ecat .....	78
Equipment supplied .....	32
Ethernet .....	49
Ethernet 1 .....	17, 46
Ethernet 2 .....	17, 46

### F

Faults .....	61
Features .....	13
Front .....	16
Further reading .....	78

### G

General data .....	73
--------------------	----

## H

### Hazards

Device-specific .....	23
-----------------------	----

## I

Initial commissioning .....	43
-----------------------------	----

Installation .....	28
--------------------	----

Installation cutout .....	34, 72
---------------------------	--------

### Installation position

Clearances .....	34
------------------	----

Selection .....	29
-----------------	----

Intended use .....	14
--------------------	----

Interfaces .....	17, 75
------------------	--------

Basic .....	46
-------------	----

CAN1 .....	54
------------	----

Equipment .....	17
-----------------	----

Ethernet .....	49
----------------	----

Profibus .....	58
----------------	----

RS-232 .....	50
--------------	----

RS-485 .....	52
--------------	----

SD card .....	47
---------------	----

serial .....	50
--------------	----

Type .....	17, 46
------------	--------

USB device .....	48
------------------	----

USB host .....	48
----------------	----

USB peripheral devices .....	48
------------------------------	----

IR Touch sensor .....	16
-----------------------	----

## J

J1939 .....	54
-------------	----

## L

Label .....	20
-------------	----

Lifespan .....	74
----------------	----

Backlight .....	44
-----------------	----

List of revisions .....	8
-------------------------	---

Location of use .....	28
-----------------------	----

## M

Maintenance .....	63
-------------------	----

Manuals .....	78
---------------	----

Materials used .....	66
----------------------	----

Missing parts .....	32
---------------------	----

Mounting .....	33
----------------	----

Mounting distance .....	31
-------------------------	----

### Mounting position

SD card .....	29
---------------	----

## N

Nameplate .....	17, 20
-----------------	--------

## O

Online Catalog .....	78
----------------------	----

Operating elements .....	16
--------------------------	----

### Operation

Proper .....	22
--------------	----

Original Operating Instructions .....	2
---------------------------------------	---

## P

Package contents .....	32
------------------------	----

Part number .....	18
-------------------	----

Ports .....	45
-------------	----

Power consumption .....	40, 76
-------------------------	--------

Power supply .....	40
--------------------	----

Power Supply .....	40, 76
--------------------	--------

Profibus .....	17, 46, 58
----------------	------------

## R

Real-time clock .....	73
-----------------------	----

Repairs .....	64
---------------	----



Resolution	
Display .....	74
RS-232 .....	50
RS-485 .....	52

## **S**

Safety .....	21
Screen area	
visible .....	74
Screen diagonal .....	74
SD card .....	47
SD card slot .....	16-17, 46
Service .....	20
Service page .....	16
Standards .....	77
Std. pack .....	32
Storage .....	65
Support .....	20
System .....	73

## **T**

Technical data .....	68
Transit damage .....	32
Transport .....	65
Troubleshooting .....	61

## **U**

USB device .....	17, 46, 48
USB host .....	17, 46, 48
USB peripheral devices .....	48

## **V**

Versions .....	18
Voltage range .....	40, 76

## **W**

Weight .....	69
--------------	----

Eaton's electrical business is a global leader with expertise in power distribution and circuit protection; backup power protection; control and automation; lighting and security; structural solutions and wiring devices; solutions for harsh and hazardous environments; and engineering services. Eaton develops innovations that not only provide energy for the important things across industries worldwide, but also help customers tackle the most critical electrical power management challenges out there.

The Eaton Corporation is a diversified power management company with 2017 sales of 20.4 billion dollars. We provide energy-efficient solutions that help our customers effectively manage electrical, hydraulic, and mechanical power more efficiently, safely, and sustainably. Eaton is dedicated to improving people's quality of life and the environment through the use of power management technologies and services. Eaton has approximately 96,000 employees and sells products to customers in more than 175 countries. For more information, please visit [Eaton.com](http://Eaton.com).

**Eaton Addresses Worldwide:**

**[www.eaton.com](http://www.eaton.com)**

**[www.eaton.eu/electrical/customersupport](http://www.eaton.eu/electrical/customersupport)**

Email: [automation@eaton.com](mailto:automation@eaton.com)

Internet: [www.eaton.eu/xv300](http://www.eaton.eu/xv300)

Eaton Industries GmbH,  
Hein-Moeller-Straße 7-11,  
D-53115 Bonn

© 2015 by Eaton Cooperation

All Rights Reserved

07/19 MN048025EN



*Powering Business Worldwide*