



# DME5000-211

## DME5000

LONG RANGE DISTANCE SENSORS

**SICK**  
Sensor Intelligence.



### Ordering information

Type	Part no.
DME5000-211	1024081

Other models and accessories → [www.sick.com/DME5000](http://www.sick.com/DME5000)



### Detailed technical data

#### Mechanics/electronics

<b>Supply voltage <math>V_s</math></b>	DC 18 V ... 30 V, limit values
<b>Ripple</b>	< 5 V <sub>pp</sub> <sup>1)</sup>
<b>Initialization time</b>	1.5 s <sup>2)</sup>
<b>Housing material</b>	Metal (zinc diecast)
<b>Window material</b>	Glass
<b>Connection type</b>	Male connector, M16, 8-pin
<b>Indication</b>	Display
<b>Weight</b>	Approx. 1,650 g
<b>Current consumption</b>	At 24 V DC < 250 mA
<b>Dimensions (W x H x D)</b>	61 mm x 101 mm x 176 mm
<b>Enclosure rating</b>	IP65
<b>Protection class</b>	II <sup>3)</sup>

<sup>1)</sup> May not fall short of or exceed  $V_s$  tolerances.

<sup>2)</sup> After loss of reflector < 1 s at max. speed  $V_{max} < 1$  m/s.

<sup>3)</sup> Reference voltage DC 32 V.

#### Safety-related parameters

<b>MTTF<sub>D</sub></b>	101 years
<b>DC<sub>avg</sub></b>	0%

#### Performance

<b>Measurement range min ... max:</b>	0.15 m ... 150 m, on "diamond grade" reflective tape <sup>1)</sup>
<b>Target</b>	Reflector
<b>Resolution</b>	0.05 mm ... 5 mm
<b>Repeatability</b>	1 mm <sup>1) 2)</sup>
<b>Accuracy</b>	± 3 mm
<b>Response time</b>	6 ms

<sup>1)</sup> On "diamond grade" reflective tape.

<sup>2)</sup> Statistical error 1  $\sigma$ , environmental conditions constant, min. warm-up time 10 min.

<sup>3)</sup> Average service life of 50,000 h at  $T_A = +25$  °C.

<b>Output time</b>	1 ms
<b>Light source</b>	Laser, red <sup>3)</sup> visible red light
<b>Laser class</b>	2, complies with 21 CFR 1040.10 and 1040.11 except for the conformance according to "Laser Notice No. 50" from June 24, 2007 (IEC 60825-1:2014, EN 60825-1:2014)
<b>Typ. light spot size (distance)</b>	130 mm (at 70 m) 270 mm (at 150 m) 360 mm (at 220 m)
<b>Max. movement speed</b>	10 m/s

<sup>1)</sup> On "diamond grade" reflective tape.

<sup>2)</sup> Statistical error  $1\sigma$ , environmental conditions constant, min. warm-up time 10 min.

<sup>3)</sup> Average service life of 50,000 h at  $T_A = +25\text{ °C}$ .

## Interfaces

<b>SSI</b>	✓
<b>Digital output</b>	
Number	2
Type	Push-pull: PNP/NPN
Maximum output current $I_A$	$\leq 100\text{ mA}$ <sup>1) 2)</sup>
<b>Multifunctional input (MF)</b>	1 x MF <sup>3) 4)</sup>

<sup>1)</sup> Max. 100 nF/20 mA.

<sup>2)</sup> HIGH =  $> V_S - 3\text{ V}$  / LOW =  $< 2\text{ V}$ .

<sup>3)</sup> HIGH =  $> 12\text{ V}$  / LOW =  $< 3\text{ V}$ .

<sup>4)</sup> Not reverse-polarity protected.

## Ambient data

<b>Electromagnetic compatibility (EMC)</b>	EN 61000-6-2, EN 55011
<b>Ambient temperature, operation</b>	-10 °C ... +55 °C -10 °C ... +75 °C, operation with cooling case
<b>Ambient temperature, storage</b>	-25 °C ... +75 °C
<b>Effect of air pressure</b>	0.3 ppm/hPa
<b>Effect of air temperature</b>	1 ppm/K
<b>Temperature drift</b>	Typ. 0.1 mm/K
<b>Typ. Ambient light immunity</b>	$\leq 40,000\text{ lx}$
<b>Mechanical load</b>	Shock: (EN 600 68-2-27 / -2-29) Sine: (EN 600 68-2-6) Noise: (EN 600 68-2-64)

## Classifications

<b>ECLASS 5.0</b>	27270801
<b>ECLASS 5.1.4</b>	27270801
<b>ECLASS 6.0</b>	27270801
<b>ECLASS 6.2</b>	27270801
<b>ECLASS 7.0</b>	27270801
<b>ECLASS 8.0</b>	27270801
<b>ECLASS 8.1</b>	27270801
<b>ECLASS 9.0</b>	27270801

<b>ECLASS 10.0</b>	27270801
<b>ECLASS 11.0</b>	27270801
<b>ECLASS 12.0</b>	27270916
<b>ETIM 5.0</b>	EC001825
<b>ETIM 6.0</b>	EC001825
<b>ETIM 7.0</b>	EC001825
<b>ETIM 8.0</b>	EC001825
<b>UNSPSC 16.0901</b>	41111613

### Dimensional drawing (Dimensions in mm (inch))

DME5000 SSI

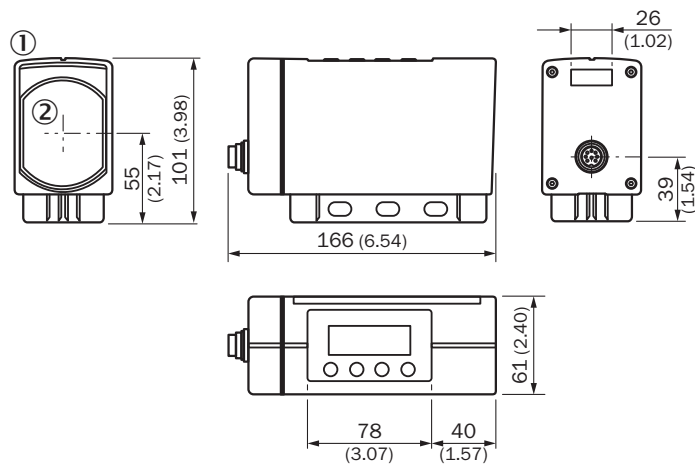

- ① LC display
- ② Center of optical axis

## Working range diagram

DL1000 measuring range based on measurement cycle time and reflector type

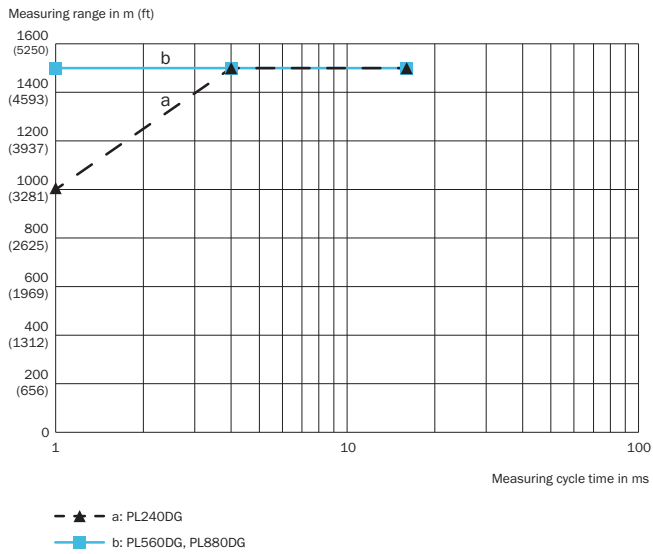

## Connection type

DME4/5xxx SSI/RS-422 Connector M16, 8-pin



## Connection diagram

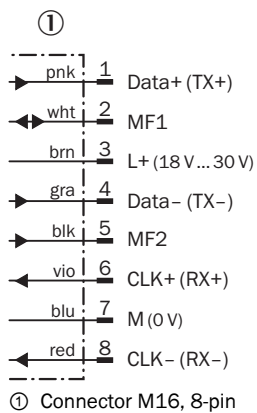



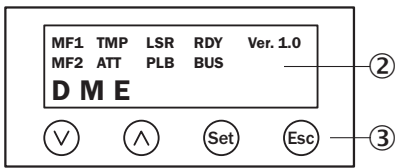



### Adjustment possible









- ② LC display
- ③ Keypad

### Recommended accessories

Other models and accessories → [www.sick.com/DME5000](http://www.sick.com/DME5000)

	Brief description	Type	Part no.
Plug connectors and cables			
	<ul style="list-style-type: none"> <li><b>Connection type head A:</b> Female connector, M12, 5-pin, straight, B-coded</li> <li><b>Connection type head B:</b> Flying leads</li> <li><b>Signal type:</b> PROFIBUS DP</li> <li><b>Cable:</b> 5 m, 2-wire, PUR, halogen-free</li> <li><b>Description:</b> PROFIBUS DP, twisted pair, shielded, Head A: female connector, M12, 5-pin, straight Head B: cable Cable: suitable for drag chain, PUR, halogen-free, shielded, 2 x 0.34 mm<sup>2</sup>, Ø 8.0 mm</li> <li><b>Connection systems:</b> Flying leads</li> <li><b>Application:</b> Zones with oils and lubricants</li> </ul>	DOL-1205-G05MQ	6026006
	<ul style="list-style-type: none"> <li><b>Connection type head A:</b> Female connector, M12, 5-pin, A-coded</li> <li><b>Connection type head B:</b> Flying leads</li> <li><b>Signal type:</b> Power, CAN</li> <li><b>Cable:</b> 5 m, 5-wire</li> <li><b>Description:</b> Power, unshielded CAN</li> </ul>	DOL-1205-G05M_Can	6021166
	<ul style="list-style-type: none"> <li><b>Connection type head A:</b> Female connector, M12, 5-pin, straight</li> <li><b>Connection type head B:</b> Flying leads</li> <li><b>Signal type:</b> CANopen</li> <li><b>Cable:</b> 6 m</li> <li><b>Description:</b> CANopen, shielded</li> </ul>	DOL-1205-G06MK	6028326
	<ul style="list-style-type: none"> <li><b>Connection type head A:</b> Female connector, M12, 5-pin, straight, B-coded</li> <li><b>Connection type head B:</b> Flying leads</li> <li><b>Signal type:</b> PROFIBUS DP</li> <li><b>Cable:</b> 10 m, 2-wire, PUR, halogen-free</li> <li><b>Description:</b> PROFIBUS DP, twisted pair, shielded</li> <li><b>Connection systems:</b> Flying leads</li> <li><b>Application:</b> Zones with oils and lubricants</li> </ul>	DOL-1205-G10MQ	6026008
	<ul style="list-style-type: none"> <li><b>Connection type head A:</b> Female connector, M12, 5-pin, straight, B-coded</li> <li><b>Connection type head B:</b> Flying leads</li> <li><b>Signal type:</b> PROFIBUS DP</li> <li><b>Cable:</b> 15 m, 2-wire, PUR, halogen-free</li> <li><b>Description:</b> PROFIBUS DP, twisted pair, shielded</li> <li><b>Connection systems:</b> Flying leads</li> <li><b>Application:</b> Zones with oils and lubricants</li> </ul>	DOL-1205-G15MQ	6032637
	<ul style="list-style-type: none"> <li><b>Connection type head A:</b> Male connector, M12, 5-pin, straight, B-coded</li> <li><b>Connection type head B:</b> Flying leads</li> <li><b>Signal type:</b> PROFIBUS DP</li> <li><b>Cable:</b> 10 m, 2-wire, PUR, halogen-free</li> <li><b>Description:</b> PROFIBUS DP, twisted pair, shielded</li> <li><b>Note:</b> Wire shield Al-Pt film, overall shield C-screen tin-plated</li> <li><b>Application:</b> Zones with oils and lubricants, Drag chain operation</li> </ul>	STL-1205-G05MQ	6026005
		STL-1205-G10MQ	6026007

	Brief description	Type	Part no.
	Head A: male connector, M12, 5-pin, straight, B-coded	STL-1205-G15MQ	6036898
	<ul style="list-style-type: none"> <li>• <b>Connection type head A:</b> Female connector, M12, 5-pin, straight</li> <li>• <b>Connection type head B:</b> Flying leads</li> <li>• <b>Signal type:</b> CANopen</li> <li>• <b>Cable:</b> 10 m, 5-wire</li> <li>• <b>Description:</b> CANopen, shielded</li> <li>• <b>Connection systems:</b> Flying leads</li> <li>• <b>Note:</b> Shielded on pin 1</li> </ul>	YF2A14-100C1BXLEAX	6021175
	Head A: female connector, M12, 8-pin, straight	YF2A68-020XXXXLEAX	6032448
		YF2A68-050XXXXLEAX	6032449
		YF2A68-100XXXXLEAX	6032450
	Head A: female connector, M16, 8-pin, straight	YF2Z18-050XXXXLEBX	2026742
		YF2Z18-100XXXXLEBX	2027193
	<ul style="list-style-type: none"> <li>• <b>Connection type head A:</b> Female connector, 7/8", 5-pin, straight</li> <li>• <b>Signal type:</b> DeviceNet™, CANopen</li> <li>• <b>Description:</b> DeviceNet™, terminal resistor, shielded CANopen</li> <li>• <b>Permitted cross-section:</b> ≤ 1.5 mm<sup>2</sup></li> <li>• <b>Note:</b> For field bus technology</li> </ul>	DOS-7805-GKEND	6028329
	<ul style="list-style-type: none"> <li>• <b>Connection type head A:</b> Male connector, M12, 4-pin, straight, B-coded</li> <li>• <b>Signal type:</b> PROFIBUS DP</li> <li>• <b>Description:</b> PROFIBUS DP, terminal resistor</li> </ul>	STE-END-Q	6021156
Reflectors			
	Reflector plate, "diamond grade" reflective tape, 665 mm x 665 mm, base plate material: aluminum, screw connection, Screw-on, 4 hole mounting	PL560DG	1016806
Terminal and alignment brackets			
	Alignment unit for DME5000, stainless steel (1.4541), incl. mounting material, additional base plate mounting kit required, mounting hardware included	BEF-AH-DME	2027721

## SICK AT A GLANCE

SICK is one of the leading manufacturers of intelligent sensors and sensor solutions for industrial applications. A unique range of products and services creates the perfect basis for controlling processes securely and efficiently, protecting individuals from accidents and preventing damage to the environment.

We have extensive experience in a wide range of industries and understand their processes and requirements. With intelligent sensors, we can deliver exactly what our customers need. In application centers in Europe, Asia and North America, system solutions are tested and optimized in accordance with customer specifications. All this makes us a reliable supplier and development partner.

Comprehensive services complete our offering: SICK LifeTime Services provide support throughout the machine life cycle and ensure safety and productivity.

For us, that is “Sensor Intelligence.”

## WORLDWIDE PRESENCE:

Contacts and other locations –[www.sick.com](http://www.sick.com)