



AS30-EBM314I110ZZZ

AS30

ARRAY SENSORS

SICK
Sensor Intelligence.



Illustration may differ



Ordering information

Type	Part no.
AS30-EBM314I110ZZZ	1095581

Other models and accessories → www.sick.com/AS30

Detailed technical data

Features

Sensor principle	Proximity system
Functional principle	Web guiding, positioning
Principle of operation (default)	Web guiding
Dimensions (W x H x D)	31 mm x 62 mm x 52.2 mm
Sensing distance	≤ 25 mm
Housing design	Rectangular
Working range	20 mm ... 30 mm
Measurement range	30 mm
Minimum detectable object (MDO)	0.2 mm
Light source	LED, White
Wave length	400 nm ... 700 nm
Light spot size	39 mm x 12.2 mm
Repeatability	0.2 mm ¹⁾
Linearity (position value)	± 2 %
Resolution	0.1 mm
Adjustment	IO-Link, Display
Teach-in mode	Edge detection Area detection

¹⁾ With respect to sensing distance.

Mechanics/electronics

Supply voltage	18 V ... 30 V
Ripple	$\leq 5 \text{ V}^{1)}$
Current consumption	$< 3.1 \text{ W}^{2)}$
Switching frequency	500 Hz
Switching output	Push-pull: PNP/NPN
Switching output (voltage)	Push-pull: PNP/NPN HIGH = $U_V - 3 \text{ V}$ /LOW $\leq 3 \text{ V}$
Analog output	4 mA ... 20 mA
Resolution of analog output	12 bit
Output rate of analog output	1 ms
Output current I_{max}	$< 100 \text{ mA}$
Initialization time	0.48 s
Connection type	Male connector M12, 5-pin
Protection class	III ³⁾
Circuit protection	U_V connections, reverse polarity protected Output Q short-circuit protected Interference pulse suppression
Enclosure rating	IP67
Weight	250 g
Housing material	Metal, zinc diecast
Optics material	Glass

1) May not exceed or fall below U_V tolerances.

2) Without load.

3) $I_N = 2 \text{ A}$.

Communication interface

IO-Link	✓
VendorID	26
DeviceID HEX	0x800207
DeviceID DEC	8389127
Cycle time	$> 1.1 \text{ ms}$

Ambient data

Ambient operating temperature	$-10 \text{ }^\circ\text{C} \dots +55 \text{ }^\circ\text{C}$
Ambient temperature, storage	$-25 \text{ }^\circ\text{C} \dots +75 \text{ }^\circ\text{C}$
Shock load	According to IEC 60068
UL File No.	NRKH.E181493 & NRKH7.E181493

Classifications

ECLASS 5.0	27270906
ECLASS 5.1.4	27270906
ECLASS 6.0	27270906
ECLASS 6.2	27270906
ECLASS 7.0	27270906
ECLASS 8.0	27270906

ECLASS 8.1	27270906
ECLASS 9.0	27270906
ECLASS 10.0	27270906
ECLASS 11.0	27270906
ECLASS 12.0	27270906
ETIM 5.0	EC001820
ETIM 6.0	EC001820
ETIM 7.0	EC001820
ETIM 8.0	EC001820
UNSPSC 16.0901	39121528

Dimensional drawing (Dimensions in mm (inch))

AS30-xxx31xxxxxxx

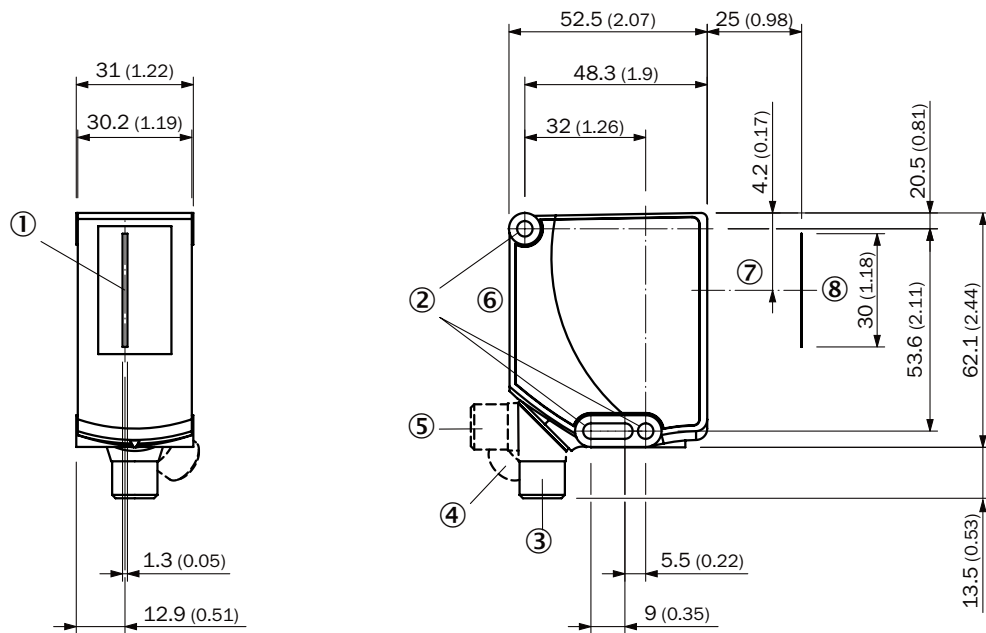

- ① Center field of view
- ② Fixing hole
- ③ M12 male connector, delivery state
- ④ M12 male connector, end stop right
- ⑤ M12 male connector, end stop left
- ⑥ Display and adjustment elements
- ⑦ Optical axis
- ⑧ Field of view

Adjustments

Display and adjustment elements

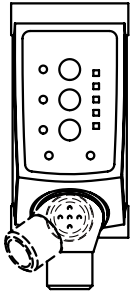



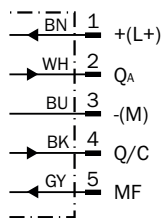

Connection diagram





Cd-435



Recommended accessories

Other models and accessories → www.sick.com/AS30

	Brief description	Type	Part no.
Universal bar clamp systems			
	Plate K for universal clamp bracket, steel, zinc coated, Universal clamp (2022726), mounting hardware	BEF-KHS-K01	2022718
	Mounting bar, straight, 200 mm, steel, steel, zinc coated, without mounting hardware	BEF-MS12G-A	4056054
	Mounting bar, L-shaped, 150 mm x 150 mm, steel, steel, zinc coated, without mounting hardware	BEF-MS12LA	4056052
Mounting brackets and plates			
	Aluminum, mounting hardware for the sensor included	BEF-AP-AS30	2124602

	Brief description	Type	Part no.
Plug connectors and cables			
	<ul style="list-style-type: none"> • Connection type head A: Female connector, M12, 5-pin, straight, A-coded • Connection type head B: Flying leads • Signal type: Sensor/actuator cable • Cable: 5 m, 5-wire, PVC • Description: Sensor/actuator cable, unshielded • Application: Zones with chemicals 	YF2A15-050VB5XLEAX	2096240
	<ul style="list-style-type: none"> • Connection type head A: Male connector, M12, 5-pin, straight • Description: Unshielded, Head A: male connector, M12, 5-pin, straight, unshielded, for cable diameter 4 mm ... 6 mm Head B: - • Connection systems: Screw-type terminals • Permitted cross-section: ≤ 0.75 mm² • Note: For field bus technology 	STE-1205-G	6022083
Terminal and alignment brackets			
	Bracket for easy mounting of ELA external illumination as a backlight. Suitable for all AS30 Prime with 25 mm sensing distance., steel, zinc coated, Mounting bracket, Screw set for AS30 and ELA	SET FORK HOLDER ELA SD25	2134662
Sensor Integration Gateway			
	<ul style="list-style-type: none"> • Further functions: Web server integrated, USB connection for easy configuration of the SIG200 Sensor Integration Gateway with SOPAS ET, the engineering tool from SICK, logic editor is available for easy configuration of logic functions • Connection CONFIG: 1 x M8, 4-pin female connector, USB 2.0 (USB-A) • Logic editor: yes • Communication interface: IO-Link, USB, Ethernet, PROFINET, REST API • Product category: IO-Link Master 	SIG200-0A0412200	1089794
	<ul style="list-style-type: none"> • Further functions: Web server integrated, USB connection for easy configuration of the SIG200 Sensor Integration Gateway with SOPAS ET, the engineering tool from SICK, logic editor is available for easy configuration of logic functions • Connection CONFIG: 1 x M8, 4-pin female connector, USB 2.0 (USB-A) • Logic editor: yes • Communication interface: IO-Link, USB, Ethernet, REST API • Product category: IO-Link Master 	SIG200-0A0G12200	1102605

Recommended services

Additional services → www.sick.com/AS30

	Type	Part no.
Function Block Factory		
<ul style="list-style-type: none"> • Description: The Function Block Factory supports common programmable logic controllers (PLCs) from various manufacturers, such as Siemens, Beckhoff, Rockwell Automation and B&R. More information on the FBF can be found here. • Note: You can configure your function block at Function Block Factory. As a login please use your SICK ID. 	Function Block Factory	On request

SICK AT A GLANCE

SICK is one of the leading manufacturers of intelligent sensors and sensor solutions for industrial applications. A unique range of products and services creates the perfect basis for controlling processes securely and efficiently, protecting individuals from accidents and preventing damage to the environment.

We have extensive experience in a wide range of industries and understand their processes and requirements. With intelligent sensors, we can deliver exactly what our customers need. In application centers in Europe, Asia and North America, system solutions are tested and optimized in accordance with customer specifications. All this makes us a reliable supplier and development partner.

Comprehensive services complete our offering: SICK LifeTime Services provide support throughout the machine life cycle and ensure safety and productivity.

For us, that is “Sensor Intelligence.”

WORLDWIDE PRESENCE:

Contacts and other locations –www.sick.com