



KTM-LN227A2P

KTM

CONTRAST SENSORS

SICK
Sensor Intelligence.



Illustration may differ



Ordering information

Type	Part no.
KTM-LN227A2P	1109744

Other models and accessories → www.sick.com/KTM

Detailed technical data

Features

Dimensions (W x H x D)	12 mm x 31.5 mm x 21 mm
Sensing distance	≤ 50 mm
Sensing distance tolerance	± 30 mm
Housing design	Small
Light source	Laser, red ¹⁾
Laser class	I
Wave length	680 nm
Light emission	Long side of housing
Light spot size	Ø 1.7 mm (50 mm)
Light spot direction	Round
Receiving filters	None
Max. web speed	10 m/s ²⁾
Adjustment	Teach-in button, Teach-in button
Teach-in mode	2-point teach-in static/dynamic + proximity to mark

¹⁾ Average service life: 100,000 h at T_U = +25 °C.

²⁾ At mark size = 1.5 mm.

Mechanics/electronics

Supply voltage	10 V DC ... 30 V DC
Ripple	$\leq 5 V_{pp}^{1)}$
Current consumption	$< 35 \text{ mA}^{2)}$
Switching frequency	4 kHz ³⁾
Response time	0.125 ms ⁴⁾
Jitter	57 μs
Accuracy	0.08 mm
Switching output	NPN
Switching output (voltage)	NPN: HIGH = approx. U_V / LOW $\leq 2 \text{ V}$
Switching mode	Light/dark switching
Output current I_{max}	100 mA ⁵⁾
Retention time (ET)	250 ms
Time delay	Switch-off delay, 520 ms (via IO-Link)
Connection type	Cable with M12 male connector, 4-pin, 0.3 m
Protection class	III
Circuit protection	U_V connections, reverse polarity protected Output Q short-circuit protected Interference pulse suppression
Enclosure rating	IP67
Weight	Approx. 24 g
Housing material	Plastic, ABS
Optics material	Plastic, PMMA
Indication	LED indicator green: power on LED indicator, yellow: Status switching output Q

1) May not exceed or fall below U_V tolerances.

2) Without load.

3) With light/dark ratio 1:1.

4) Signal transit time with resistive load.

5) At supply voltage $> 24 \text{ V}$, $I_{max} = 50 \text{ mA}$. I_{max} is consumption count of all Q_n .

Communication interface

IO-Link	✓, V1.1
Data transmission rate	38,4 kbit/s (COM2)
Cycle time	2.3 ms
Process data length	16 Bit
Process data structure A	Bit 0 = switching signal Q_{L1} Bit 1 = switching signal Q_{L2} Bit 2 = switching signal Q_{Int1} Bit 3 ... 5 = empty Bit 6 ... 15 = measuring value
Process data structure B	Bit 0 = switching signal Q_{L1} Bit 1 = switching signal Q_{L2} Bit 2 = switching signal Q_{Int1} Bit 3 ... 15 = empty
Digital output	Q_1, Q_2

Number	2
--------	---

Ambient data

Ambient operating temperature	-20 °C ... +45 °C
Ambient temperature, storage	-40 °C ... +70 °C
Shock load	According to IEC 60068
UL File No.	E181493

Classifications

ECLASS 5.0	27270906
ECLASS 5.1.4	27270906
ECLASS 6.0	27270906
ECLASS 6.2	27270906
ECLASS 7.0	27270906
ECLASS 8.0	27270906
ECLASS 8.1	27270906
ECLASS 9.0	27270906
ECLASS 10.0	27270906
ECLASS 11.0	27270906
ECLASS 12.0	27270906
ETIM 5.0	EC001820
ETIM 6.0	EC001820
ETIM 7.0	EC001820
ETIM 8.0	EC001820
UNSPSC 16.0901	39121528

Connection/Pin assignment

Connection type	Cable with M12 male connector, 4-pin, 0.3 m	
Pin assignment	BN 1	+ (L+)
	WH 2	Q
	BU 3	- (M)
	BK 4	Q/C

Dimensional drawing (Dimensions in mm (inch))

KTM-Lxxxxx2P

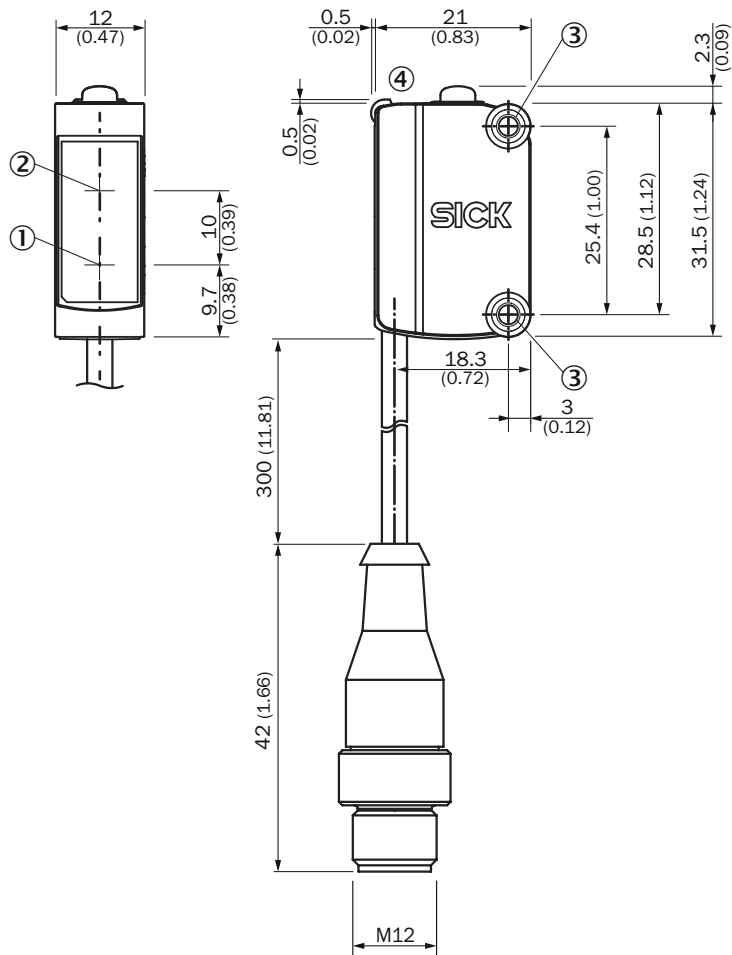

- ① Center of optical axis, sender
- ② Center of optical axis, receiver
- ③ Mounting holes M3
- ④ Display and adjustment elements

Adjustments

Display and adjustment elements

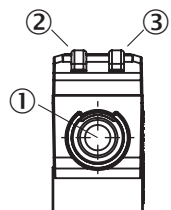

- ① Teach-in button
- ② LED yellow
- ③ LED green

Pin assignment

Connection type. see table: Connection/PIN assignment

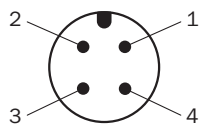

M12 male connector, 4-pin, A-coding

Sensing distance

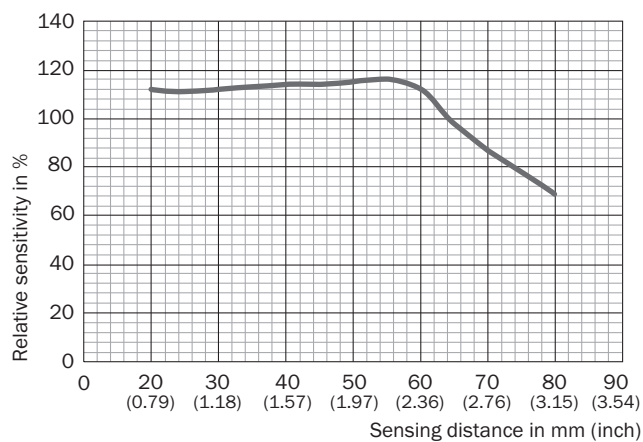

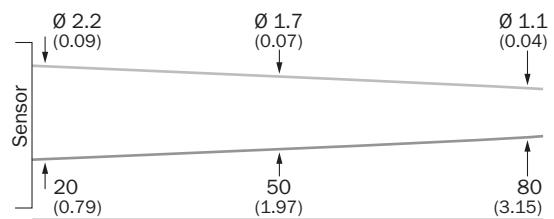

Light spot size

KTM-Lxx2xxxx



Recommended accessories

Other models and accessories → www.sick.com/KTM

	Brief description	Type	Part no.
Plug connectors and cables			
	<ul style="list-style-type: none"> • Connection type head A: Female connector, M12, 4-pin, straight, A-coded • Connection type head B: Flying leads • Signal type: Sensor/actuator cable • Cable: 5 m, 4-wire, PVC • Description: Sensor/actuator cable, unshielded • Application: Zones with chemicals 	YF2A14-050VB3XLEAX	2096235
	<ul style="list-style-type: none"> • Connection type head A: Female connector, M12, 4-pin, straight, A-coded • Connection type head B: Male connector, M12, 4-pin, straight, A-coded • Signal type: Sensor/actuator cable • Cable: 5 m, 4-wire, PVC • Description: Sensor/actuator cable, unshielded • Application: Zones with chemicals 	YF2A14-050VB3M2A14	2096600

SICK AT A GLANCE

SICK is one of the leading manufacturers of intelligent sensors and sensor solutions for industrial applications. A unique range of products and services creates the perfect basis for controlling processes securely and efficiently, protecting individuals from accidents and preventing damage to the environment.

We have extensive experience in a wide range of industries and understand their processes and requirements. With intelligent sensors, we can deliver exactly what our customers need. In application centers in Europe, Asia and North America, system solutions are tested and optimized in accordance with customer specifications. All this makes us a reliable supplier and development partner.

Comprehensive services complete our offering: SICK LifeTime Services provide support throughout the machine life cycle and ensure safety and productivity.

For us, that is “Sensor Intelligence.”

WORLDWIDE PRESENCE:

Contacts and other locations –www.sick.com