



Product designation				Power contactor
Product type designation				BF26
Contact characteristics				
Number of poles	Nr.			4
Rated insulation voltage U _i IEC/EN	V			690
Rated impulse withstand voltage U _{imp}	kV			6
Operational frequency	min	Hz	25	
	max	Hz	400	
IEC Conventional free air thermal current I _{th}	A			45
Operational current I _e	AC-1 (≤40°C)	A	45	
	AC-1 (≤55°C)	A	36	
	AC-1 (≤70°C)	A	32	
	AC-3 (≤440V ≤55°C)	A	26	
	AC-4 (400V)	A	11.5	
Rated operational power AC-1 (T≤40°C)	230V	kW	17	
	400V	kW	30	
	500V	kW	37	
	690V	kW	51	
IEC max current I _e in DC1 with L/R ≤ 1ms with 1 poles in series	≤24V	A	25	
	48V	A	21	
	75V	A	18	
	110V	A	6	
	220V	A	–	
IEC max current I _e in DC1 with L/R ≤ 1ms with 2 poles in series	≤24V	A	28	
	48V	A	28	
	75V	A	25	
	110V	A	22	
	220V	A	2	
IEC max current I _e in DC1 with L/R ≤ 1ms with 3 poles in series	≤24V	A	28	
	48V	A	28	
	75V	A	25	
	110V	A	24	
	220V	A	20	
IEC max current I _e in DC1 with L/R ≤ 1ms with 4 poles in series	≤24V	A	28	
	48V	A	28	
	75V	A	25	
	110V	A	24	
	220V	A	26	

IEC max current I_e in DC3-DC5 with L/R ≤ 15ms with 1 poles in series

≤24V	A	18
48V	A	15
75V	A	13
110V	A	2
220V	A	–

IEC max current I_e in DC3-DC5 with L/R ≤ 15ms with 2 poles in series

≤24V	A	20
48V	A	20
75V	A	18
110V	A	13
220V	A	3

IEC max current I_e in DC3-DC5 with L/R ≤ 15ms with 3 poles in series

≤24V	A	25
48V	A	25
75V	A	20
110V	A	18
220V	A	19

IEC max current I_e in DC3-DC5 with L/R ≤ 15ms with 4 poles in series

≤24V	A	30
48V	A	30
75V	A	25
110V	A	20
220V	A	15

Short-time allowable current for 10s (IEC/EN60947-1)

A	210
---	-----

Protection fuse

gG (IEC)	A	50
aM (IEC)	A	32

Making capacity (RMS value)

A	260
---	-----

Breaking capacity at voltage

440V	A	208
500V	A	184
690V	A	168

Resistance per pole (average value)

mΩ	2
----	---

Power dissipation per pole (average value)

I _{th}	W	4
AC-3	W	1.4

Tightening torque for terminals

min	Nm	2.5
max	Nm	3
min	I _{bin}	1.8
max	I _{bin}	2.2

Tightening torque for coil terminal

min	Nm	0.8
max	Nm	1
min	I _{bin}	0.8
max	I _{bin}	0.74

Max number of wires simultaneously connectable

Nr.	2
-----	---

Conductor section

AWG/Kcmil

max	6
-----	---

Flexible w/o lug conductor section

min	mm ²	2.5
-----	-----------------	-----

		max	mm ²	16
Flexible c/w lug conductor section		min	mm ²	1
		max	mm ²	10
Flexible with insulated spade lug conductor section		min	mm ²	1
		max	mm ²	10
Power terminal protection according to IEC/EN 60529				IP20 when properly wired
Mechanical features				
Operating position		normal allowable		Vertical plan ±30°
Fixing				Screw / DIN rail 35mm
Weight			g	660
Conductor section	AWG/kcmil conductor section	max		6
Operations				
Mechanical life			cycles	20000000
Electrical life			cycles	1600000
Safety related data				
Performance level B10d according to EN/ISO 13489-1		rated load mechanical load	cycles	1600000
			cycles	20000000
Mirror contacts according to IEC/EN 60947-4-1				yes
EMC compatibility				yes
DC coil operating				
DC rated control voltage			V	12
DC operating voltage	pick-up	min	%Us	80
		max	%Us	125
	drop-out	min	%Us	10
		max	%Us	40
Average coil consumption ≤20°C		in-rush holding	W	5.4
			W	5.4
Max cycles frequency				
Mechanical operation			cycles/h	3600
Operating times				
Average time for Us control in AC	Closing NO	min	ms	8
		max	ms	24
	Opening NO	min	ms	5
		max	ms	15
	Closing NC	min	ms	9
		max	ms	20

	Opening NC	min	ms	9
		max	ms	17
in DC				
	Closing NO	min	ms	54
		max	ms	66
	Opening NO	min	ms	14
		max	ms	17

UL technical data

Full-load current (FLA) for three-phase AC motor	at 480V	A	21
	at 600V	A	22

Yielded mechanical performance			
for single-phase AC motor			
	110/120V	HP	2
	230V	HP	5
for three-phase AC motor			
	200/208V	HP	7.5
	220/230V	HP	7.5
	460/480V	HP	15
	575/600V	HP	20

General USE			
Contactor	AC current	A	45
	Short-circuit protection fuse, 600V		
High fault	Short circuit current	kA	100
	Fuse rating	A	100
	Fuse class		J
Standard fault	Short circuit current	kA	5
	Fuse rating	A	100

Ambient conditions

Temperature			
Operating temperature			
	min	°C	-50
	max	°C	70
Storage temperature			
	min	°C	-60
	max	°C	80
Max altitude		m	3000

Resistance & Protection

Pollution degree	3
------------------	---

Dimensions

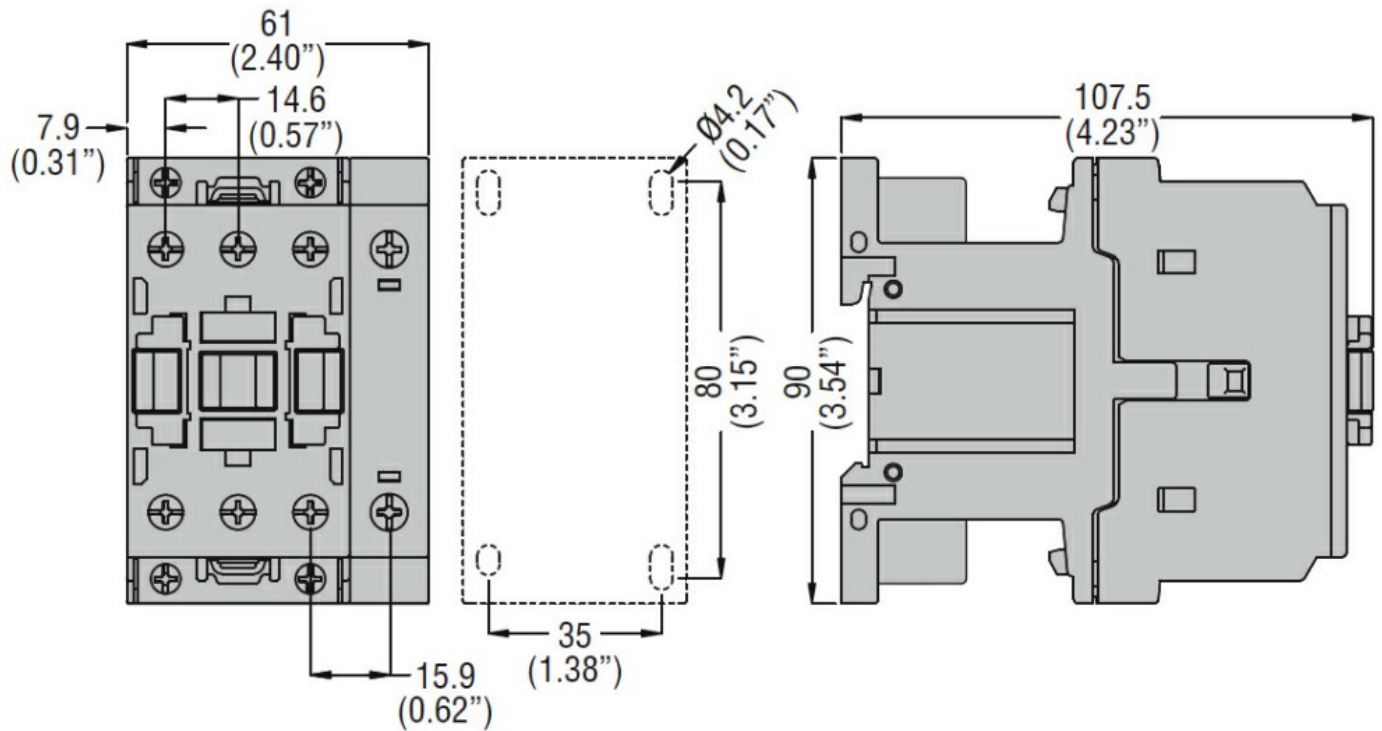

Wiring diagrams

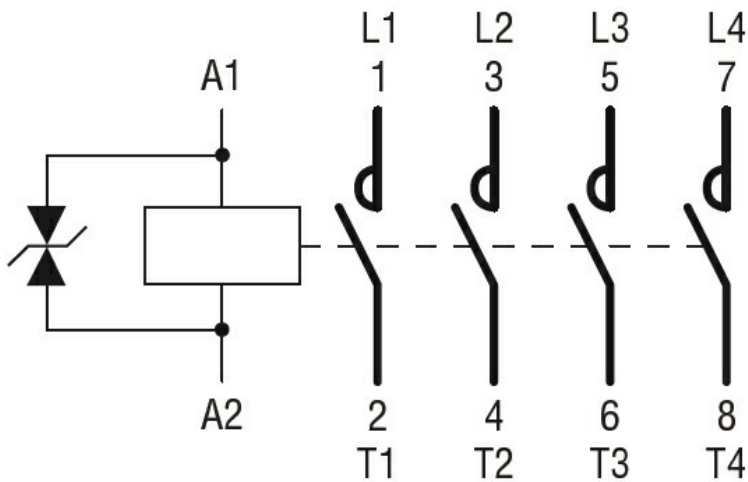

Certifications and compliance

Compliance

- CSA C22.2 n° 60947-1
- CSA C22.2 n° 60947-4-1
- IEC/EN/BS 60947-1
- IEC/EN/BS 60947-4-1
- UL 60947-1
- UL 60947-4-1

Certificates

- CCC
- cULus
- EAC

ETIM classification

ETIM 8.0

EC000066 -
Power contactor,
AC switching