

1 Scellement des tiges & fixation du mât

Install anchor J-Bolts in concrete foundation & fix the mast

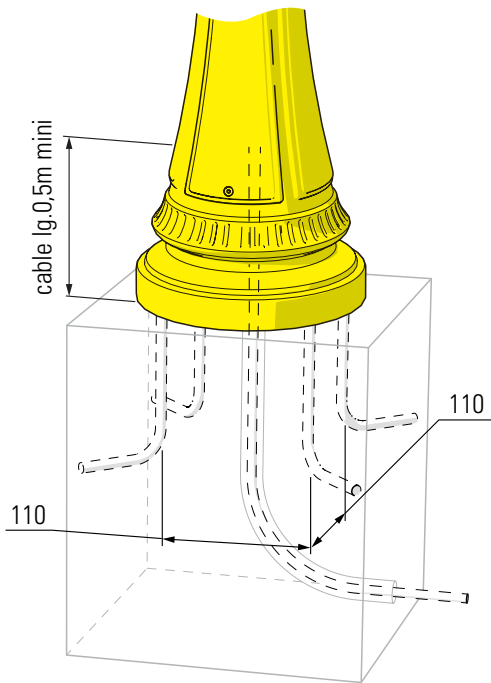

2 Montage des bras

Assemble the brackets

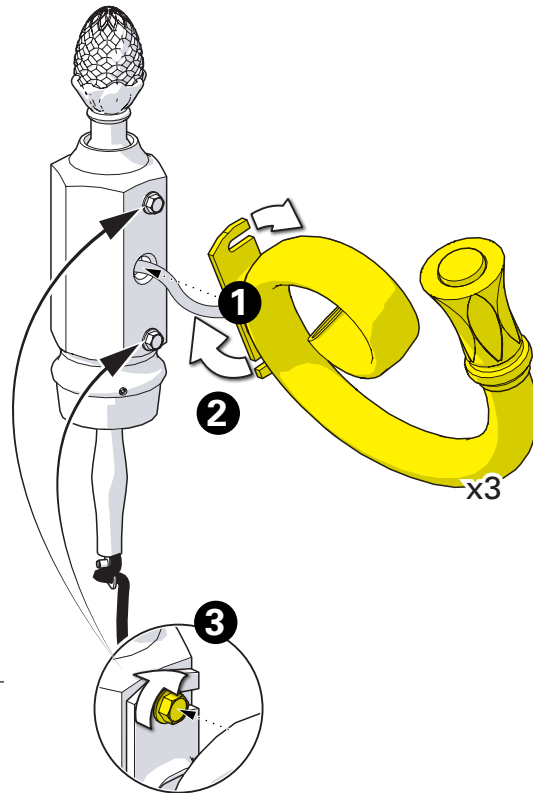

3 Montage de l'ensemble sur le mât

Mount the sub-assembly on the mast

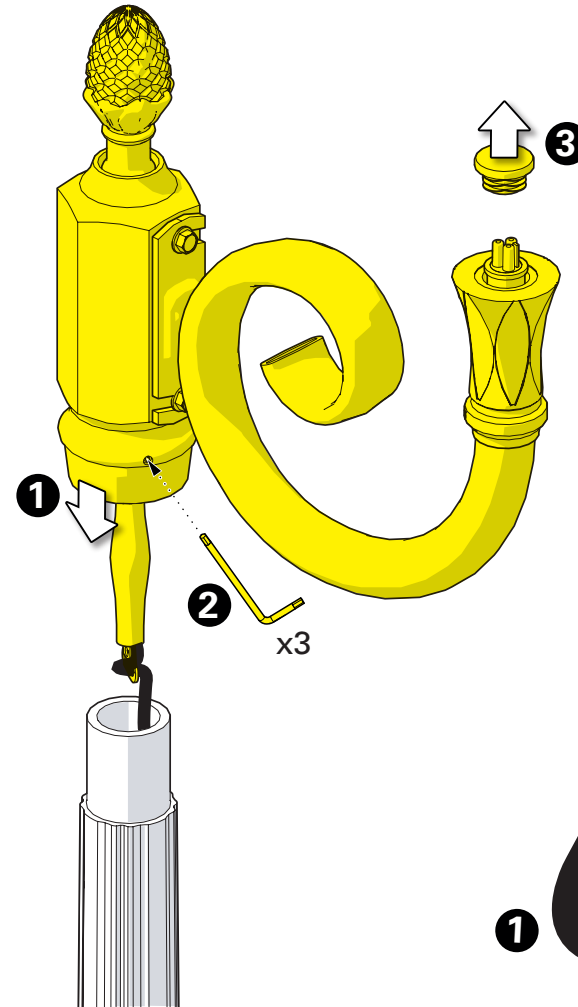

4 Raccordement électrique

Connect electrical wires

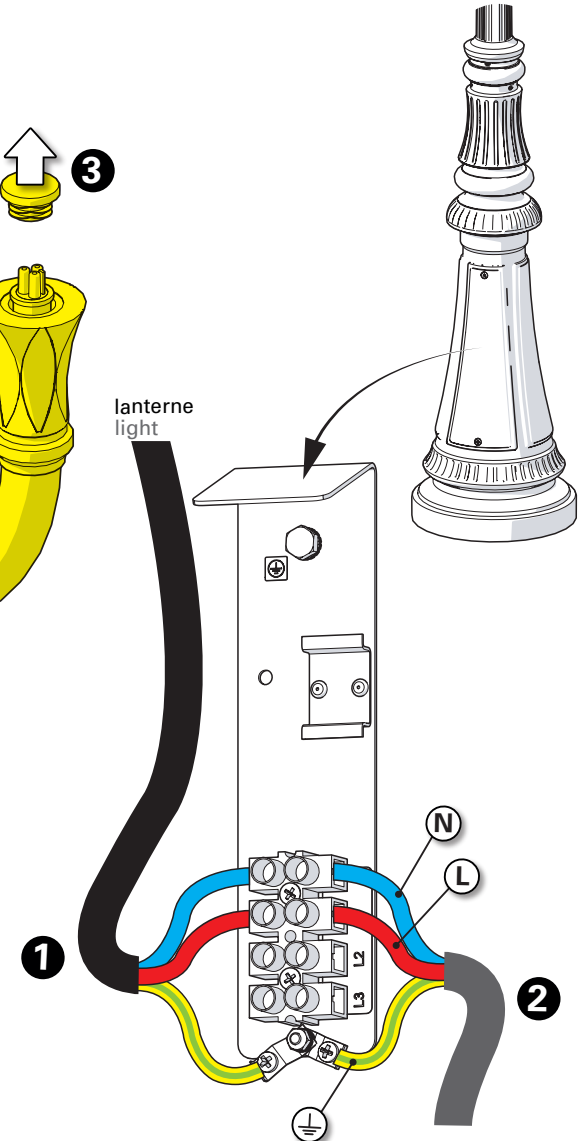

5 Montage du globe & du chapiteau
Install the globe & the dome

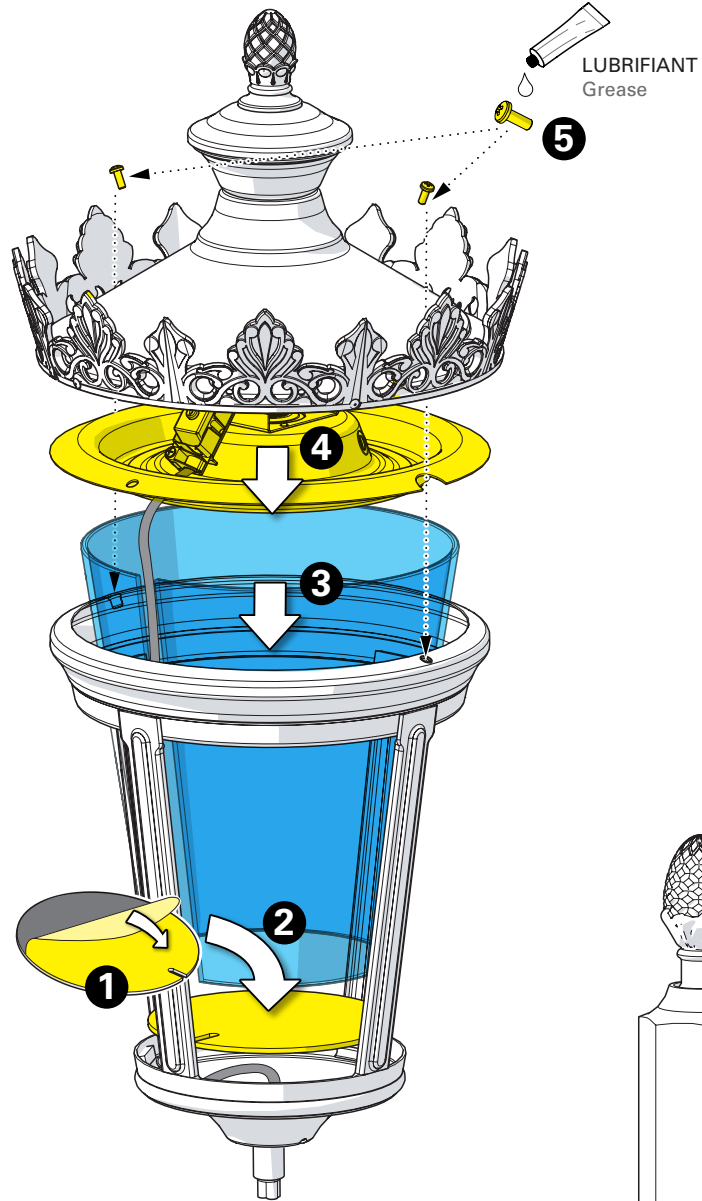

6 Fixation des luminaires
Fix the luminaires

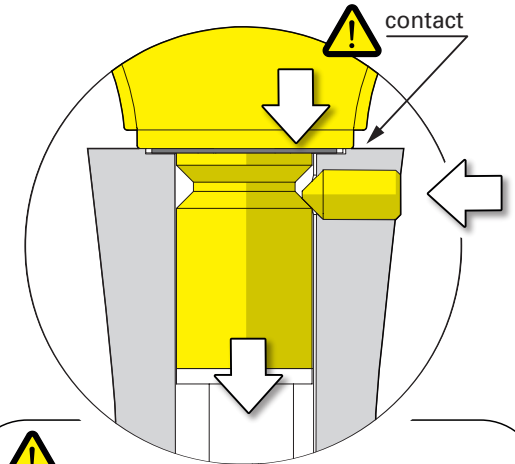

!
Serrer la vis dans la gorge pour maintenir le contact et la compression du joint d'étanchéité
Tighten the screw into the groove in order to keep surface in contact and ensure proper sealing gasket compression

