

# LANDA®

illuminotecnica

## IM SERIE 5351 MIRA 65

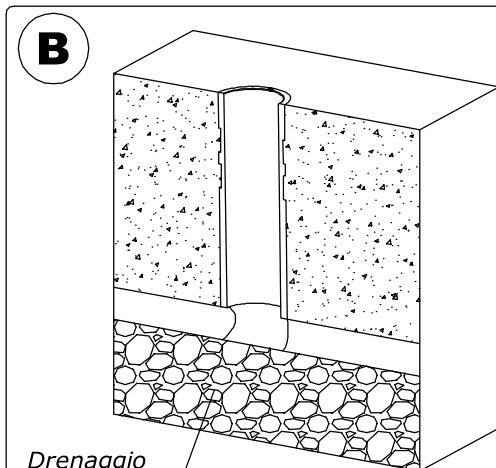
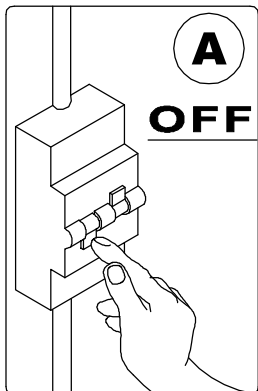
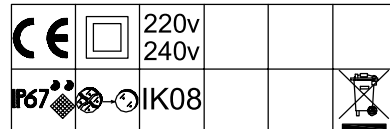

Drenaggio  
Drenaige  
25Cm Min.

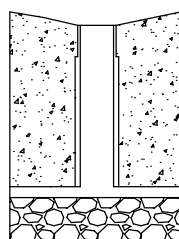

NO

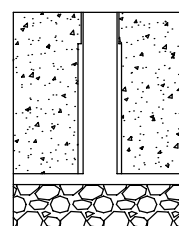

OK

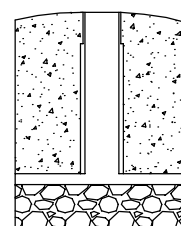

OK

**C**

cod.0404M009  
connettore a richiesta  
connector on request  
connecteur sur demande

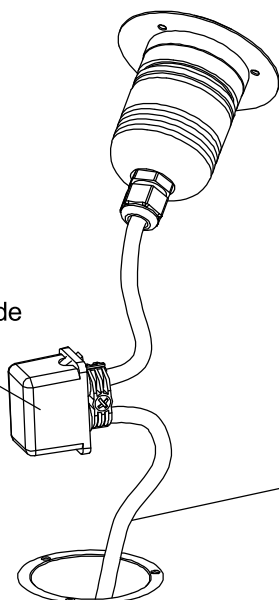

H05RN-F

sez.6-8mm

- Se il cavo flessibile esterno di questo apparecchio viene danneggiato, deve essere sostituito dal costruttore o dal suo servizio assistenza al fine di evitare pericoli. Per il cablaggio dell'apparecchio si dovrà utilizzare un'adonea morsettiera omologata EN 60998-2-1 o EN 60998-2-2 installata in una scatola di cablaggio adeguata con grado di protezione IP68.

- If the external cable of this appliance is damage, it must be replaced by the manufacturer or its service in order to avoid dangers. For wiring the terminal you should use a suitable approved to EN 60998-2-1 or EN 60998-2-2 installed in a wiring box with adequate degree of protection IP68.

- Si le cordon d'alimentation externe de cet appareil est endommagé, celui-ci doit être remplacé par le fabricant ou son service de maintenance. Pour le câblage externe il est nécessaire d'utiliser un bloc de jonction ou un connecteur (non fournis) spécifique extérieure, avec un degré de protection IP 68.

- Si el cable de alimentación externa de este aparato está dañado, debe ser reemplazado por el fabricante o su servicio con el fin de evitar los peligros. Para el cableado del terminal debe utilizar un adecuado aprobado a la norma EN 60998-2-1 EN 60998-2-2 o instalados en una caja de cableado, con adecuado grado de protección IP68.

- Wenn das externe Netzkabel dieses Gerätes beschädigt ist, muss es vom Hersteller oder dem Dienst ersetzt werden, um Gefahren zu vermeiden. Für die Verdrahtung der Klemme sollten Sie eine geeignete zugelassen nach EN 60998-2-1 oder EN 60998-2-2 in einer Anschlussdose mit angemessenen Mindesteinkommen Schutzart IP68 eingebaut.

**D**

220-240v  
50-60Hz

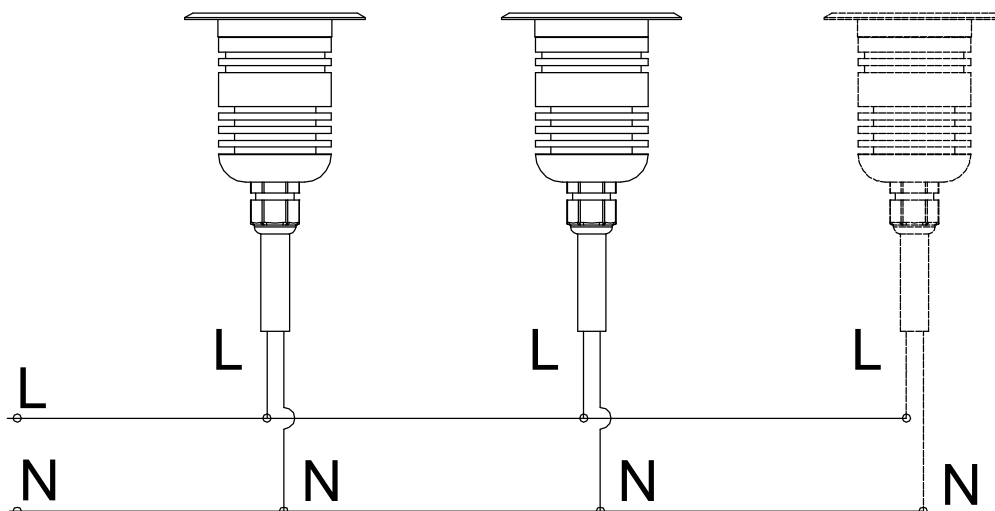

# LANDA®

illuminotecnica

## IM SERIE 5351 MIRA 65

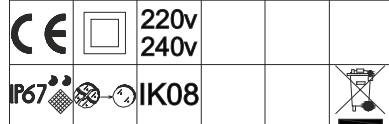

### E

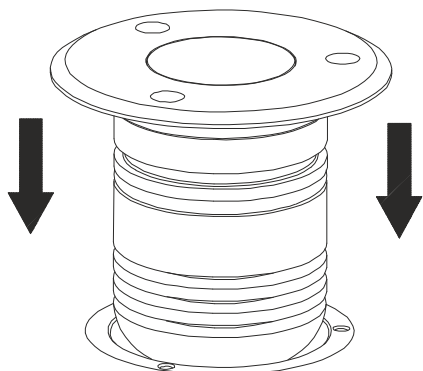

### F

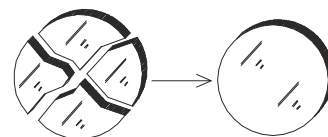
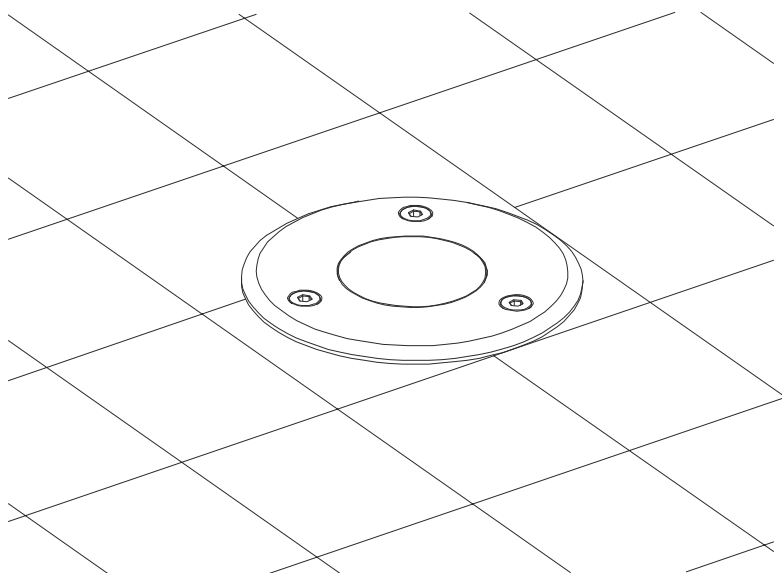
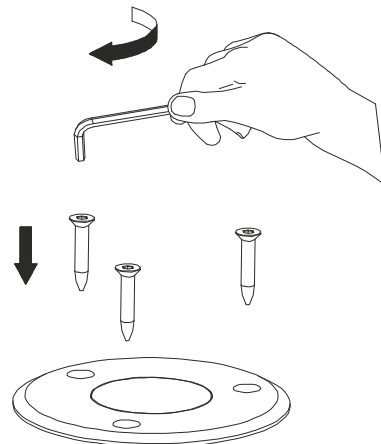

- In caso di rottura del vetro il prodotto non può essere utilizzato , contattare il fornitore per la sua sostituzione .

- Should the glass break , the product cannot be used and you should contact the manufacturer for its replacement .

- En cas d'endommagement de l'écran de protection le produit ne peut pas être utilisé , contactez le fabricant pour le remplacement .

- Falls das Glas kaputt sein sollte, kann das produkt nicht verwendet werden. Kontaktieren Sie in dem Fall den Hersteller, um das Glas zu ersetzen .

- No utilizar el producto en caso de roptura del vidrio y contactar el fabricante para la sustitución.

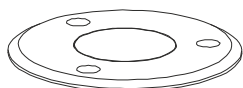

## 5351



Apparecchio calpestabile .  
Walk over fitting .  
Begehbare Leuchten .  
Appareils piétonniers .  
Aparato pisable .



Apparecchio carrabile .  
Drive over fitting .  
Überrollbarc .  
Appareils piétonniers .  
Aparato pisable .

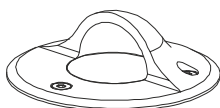
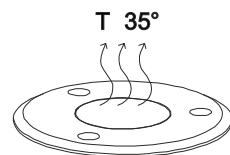
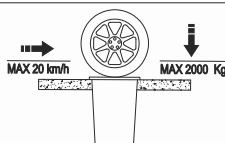

## 5352



Apparecchio carrabile .  
Drive over fitting .  
Überrollbarc .  
Appareils piétonniers .  
Aparato pisable .

