

EU
xComfort CKOZ-00/14

CKOZ-00/14

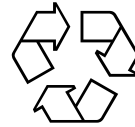
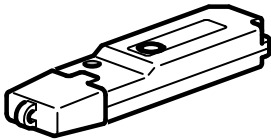

	T=-25°C - +70°C
	T=-5°C - +45°C

IP20

868,3 MHz

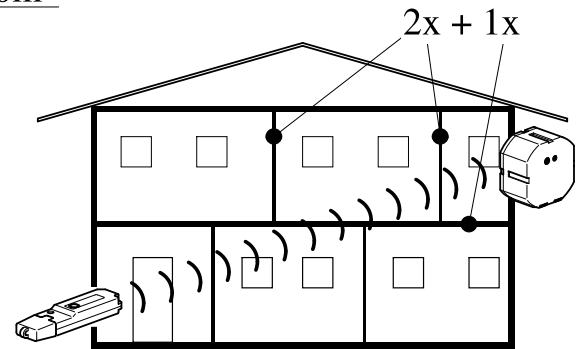
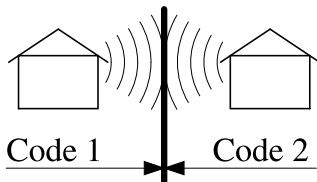
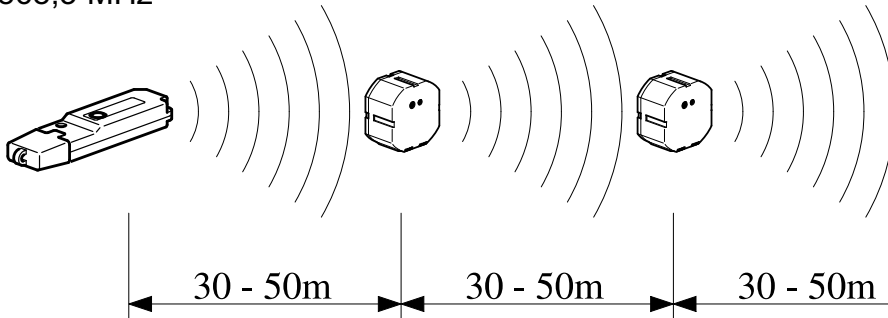

	~ 60-90%	~ 80-95%	~ 20-60%	~ 0-10%	~ 70-90%

1

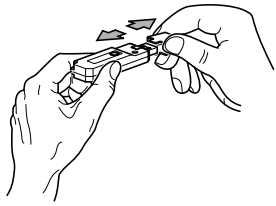

2

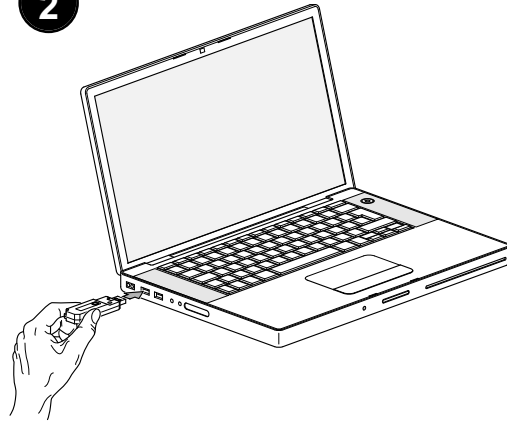

3

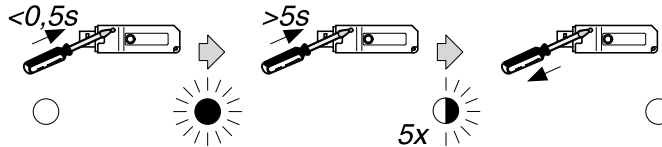
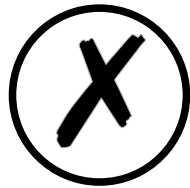
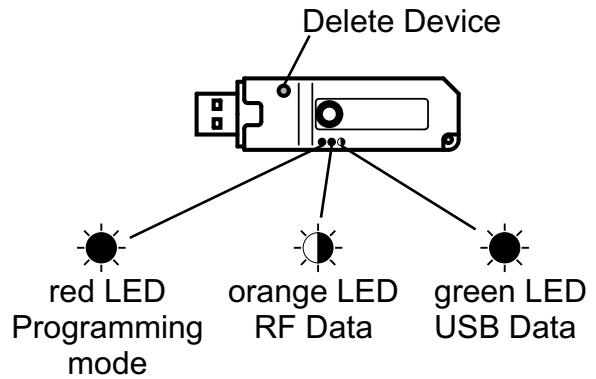

Declaration of Conformity

We, EATON Industries (Austria) GmbH
3943 Schrems, Eugenia 1
Austria

declare under our sole responsibility that the product (family)

**Eaton - Communication Stick,
CKOZ-00/14**

(the declaration of conformity applies to all listed types within our actual product catalogue)

provided that it is installed, maintained and used in the application intended for, with respect to the relevant manufacturers instructions, installation standards and "good engineering practices"

complies with the provisions of Council directive(s):

RED Directive 2014/53/EU

RoHS Directive 2011/65/EU

based on compliance with following standard(s):

EN 301489-3 V2.1.1, EN 300220-2 V3.1.1, EN 50491-5-1:2010,
EN 50491-5-2:2010, EN 62479:2010, EN 60950-1:2006 + A11:2009 +
A1:2010 + A12:2011 + A2:2013, EN 50581:2012

EU- type examination performed by:
TUV Austria Services GmbH, Notified Body
1230 Vienna, Deutschstrasse 10, Austria

Affixing date of CE mark: 2012
Doc.Id.: CKOZ-0014_171117

Fernando Ceccarelli

Senior Vice President
General Manager

Friedrich Schröder

Director Quality
& Systems

17.11.2017

