



Residual current circuit breakers (RCCB) with overcurrent protection  
P1RE  
1P+N  
2  
IEC

Product designation

Product type designation

Number of poles

Number of DIN modules

Compliance

**Electrical features**

Rated insulation voltage $U_i$ IEC/EN	V	400
Rated impulse withstand voltage $U_{imp}$	kV	4
Rated operational voltage AC (IEC)	VAC	230
Rated frequency	Hz	50/60
Rated current ( $I_n$ )	A	16
Tripping curve		C
Residual operation characteristic		A
Rated residual current	mA	30
Short circuit rating (IEC)	kA	10
Electrical life	cycles	10000

**Ambient conditions**

Operating temperature	min	°C	-25
	max	°C	+60
Storage temperature	min	°C	-40
	max	°C	+80
Max altitude	m	2000	

**Mechanical features**

Operating position	normal	Vertical plan		
		35mm DIN rail		
Fixing				
Tightening torque for terminals	max	Nm	2	
	max	Ibin	15	
Terminals tool		Pz 2		
Conductor section	IEC	min	mm <sup>2</sup>	1
		max	mm <sup>2</sup>	16
	AWG/Kcmil	min		16
		max		3
Mechanical life		cycles	20000	
Weight		g	205	

Frontal IP degree	IP20
Pollution degree	2

**Dimensions**

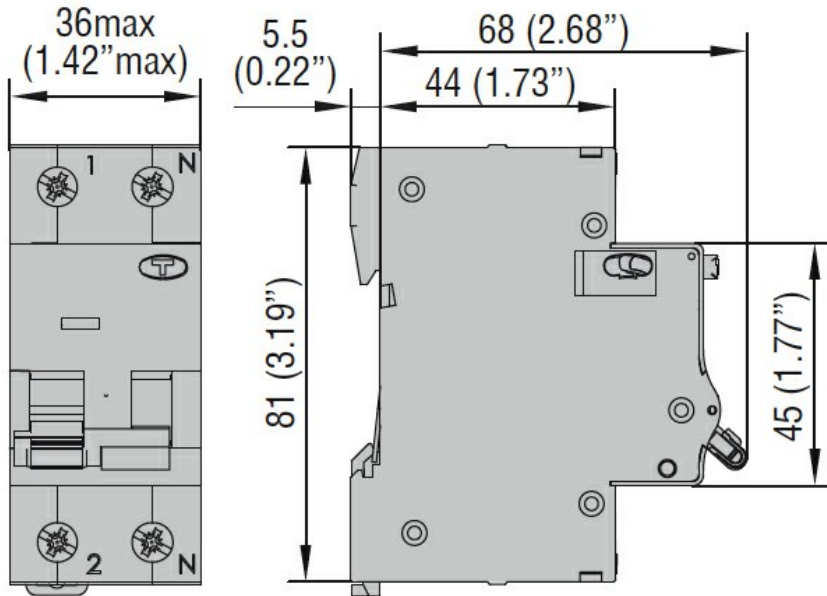

**Certifications and compliance**

Compliance	IEC/EN/BS 61009-1
Certifications	EAC TÜV-SUD

**ETIM classification**

ETIM 8.0	EC000905 - Earth leakage circuit breaker
----------	--