

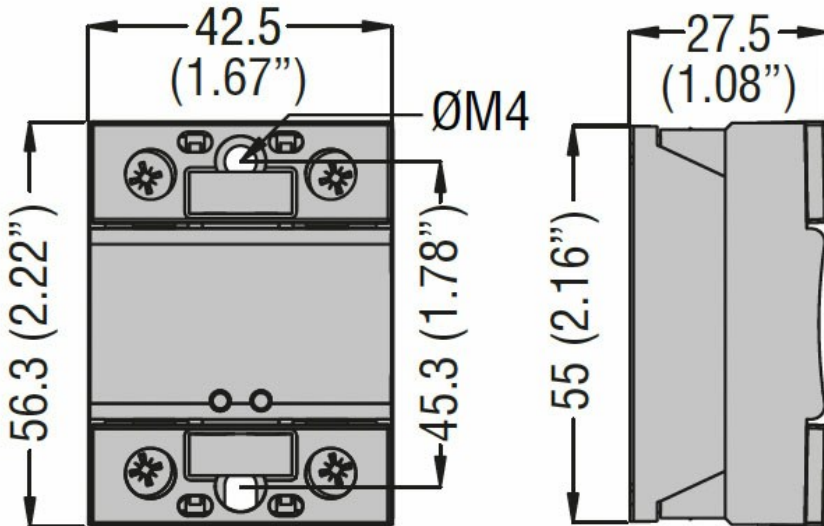

Product designation	Solid state relay		
Product type designation	HS1B		
Type	single-phase		
Input characteristics			
Control voltage	3.5...32VDC		
Operating voltage limits	Operating voltage pick-up	V	3.5
	Operating voltage drop-out	V	2
Input current at min...max voltage		mA	10...13
Input reverse voltage		V	32
Operating times			
Switching-on	Half cycle max		
Switching-off	Half cycle max		
Output characteristics			
Switching mode	Zero crossing		
Rated operating voltage	VAC	24...510	
Blocking voltage	V	1200	
Operational frequency (min...max)	Hz	45...65	
Rated operating current AC-51 (resistive load) at 40°C	A	40	
Rated operating current AC-51 (resistive load) at 55°C	A	35	
Heatsink for use at 40°C and 55°C at rated current AC-51	K/W	≤0.9	
Rated operating current AC-53 (motor load) at 40°C	A	7	
Operational current min	A	0.05	
Non repetitive surge peak on state current t=10ms	A	500	
Off state leakage current	mA	1	
On state output voltage drop	V	1.5	
Critical rate of rise of off-state voltage dv/dt	V/μs	500	
Input - Output isolation	V	4000	
Input - Output to metal base	V	4000	
Output protection type	VDR		
I2t	A2s	1250	
Terminal characteristics			
Control terminals	Type	Screw M4	
Terminals tool	PZ2		
Tightening torque control terminals	Nm	1.2...2	
	Ibin	10.6...17.7	
Conductor section connectable (control terminals) with 1 or 2 wires min...max	AWG stranded	n°	18...14
	Flexible w/o lug	mm2	0.75...2.5
	Flexible c/w insulated spade lug	mm2	0.75...2.5
Load terminals	Type	Screw M5	
Load terminals tool	PZ2		
Tightening torque load terminals	Nm	2...3	

		lbin	20.4
Conductor section connectable (load terminals) with 1 or 2 wires min...max			
	AWG stranded	n°	16...10
	Flexible w/o lug	mm2	1.5...6
	Flexible c/w insulated spade lug	mm2	1.5...6
Operating position		allowable	Any
Fixing			Screw
Ambient conditions			
Temperature			
	Operating temperature		
		min	°C -40
		max	°C +90
	Storage temperature		
		min	°C -40
		max	°C +100

Dimensions



Certifications and compliance

Certifications

IEC/EN/BS 60947-4-2
IEC/EN/BS 60947-4-3
IEC/EN/BS 62314
IEC/EN/BS 6335-1

Compliance

CSA
cURus
VDE

ETIM classification

EC000066 - Power contactor, AC switching