



Product designation				Power contactor
Product type designation				BF09
<b>Contact characteristics</b>				
Number of poles	Nr.			4
Rated insulation voltage U <sub>i</sub> IEC/EN	V			690
Rated impulse withstand voltage U <sub>imp</sub>	kV			6
Operational frequency	min	Hz	25	
	max	Hz	400	
IEC Conventional free air thermal current I <sub>th</sub>	A			25
Operational current I <sub>e</sub>	AC-1 (≤40°C)	A	25	
	AC-1 (≤55°C)	A	20	
	AC-1 (≤70°C)	A	18	
	AC-3 (≤440V ≤55°C)	A	9	
	AC-4 (400V)	A	4.9	
Rated operational power AC-1 (T≤40°C)	230V	kW	9.5	
	400V	kW	16	
	500V	kW	21	
	690V	kW	27	
IEC max current I <sub>e</sub> in DC1 with L/R ≤ 1ms with 1 poles in series	≤24V	A	15	
	48V	A	13	
	75V	A	12	
	110V	A	6	
	220V	A	–	
IEC max current I <sub>e</sub> in DC1 with L/R ≤ 1ms with 2 poles in series	≤24V	A	18	
	48V	A	18	
	75V	A	17	
	110V	A	12	
	220V	A	1	
IEC max current I <sub>e</sub> in DC1 with L/R ≤ 1ms with 3 poles in series	≤24V	A	20	
	48V	A	20	
	75V	A	20	
	110V	A	15	
	220V	A	10	
IEC max current I <sub>e</sub> in DC1 with L/R ≤ 1ms with 4 poles in series	≤24V	A	20	
	48V	A	20	
	75V	A	20	
	110V	A	16	
	220V	A	12	

IEC max current I<sub>e</sub> in DC3-DC5 with L/R ≤ 15ms with 1 poles in series

≤24V	A	10
48V	A	9
75V	A	8
110V	A	2
220V	A	–

IEC max current I<sub>e</sub> in DC3-DC5 with L/R ≤ 15ms with 2 poles in series

≤24V	A	13
48V	A	11
75V	A	10
110V	A	7
220V	A	2

IEC max current I<sub>e</sub> in DC3-DC5 with L/R ≤ 15ms with 3 poles in series

≤24V	A	15
48V	A	15
75V	A	13
110V	A	11
220V	A	6

IEC max current I<sub>e</sub> in DC3-DC5 with L/R ≤ 15ms with 4 poles in series

≤24V	A	15
48V	A	15
75V	A	15
110V	A	12
220V	A	7

Short-time allowable current for 10s (IEC/EN60947-1)

A	150
---	-----

Protection fuse

gG (IEC)	A	25
aM (IEC)	A	10

Making capacity (RMS value)

A	90
---	----

Breaking capacity at voltage

440V	A	72
500V	A	72
690V	A	71

Resistance per pole (average value)

mΩ	2.5
----	-----

Power dissipation per pole (average value)

I <sub>th</sub>	W	1.6
AC-3	W	0.2

Tightening torque for terminals

min	Nm	1.5
max	Nm	1.8
min	I <sub>bin</sub>	1.1
max	I <sub>bin</sub>	1.5

Tightening torque for coil terminal

min	Nm	0.8
max	Nm	1
min	I <sub>bin</sub>	0.8
max	I <sub>bin</sub>	0.74

Max number of wires simultaneously connectable

Nr.	2
-----	---

Conductor section

AWG/Kcmil

max	10
-----	----

Flexible w/o lug conductor section

min	mm <sup>2</sup>	1
-----	-----------------	---

		max	mm <sup>2</sup>	6
Flexible c/w lug conductor section		min	mm <sup>2</sup>	1
		max	mm <sup>2</sup>	4
Flexible with insulated spade lug conductor section		min	mm <sup>2</sup>	1
		max	mm <sup>2</sup>	4
Power terminal protection according to IEC/EN 60529				IP20 when properly wired
<b>Mechanical features</b>				
Operating position		normal allowable		Vertical plan ±30°
Fixing				Screw / DIN rail 35mm
Weight			g	500
Conductor section	AWG/kcmil conductor section	max		10
<b>Operations</b>				
Mechanical life			cycles	20000000
Electrical life			cycles	2000000
<b>Safety related data</b>				
Performance level B10d according to EN/ISO 13489-1		rated load mechanical load	cycles	2000000
			cycles	20000000
Mirror contacts according to IEC/EN 60947-4-1				yes
EMC compatibility				yes
<b>DC coil operating</b>				
DC rated control voltage			V	220
DC operating voltage	pick-up	min	%Us	70
		max	%Us	125
	drop-out	min	%Us	10
		max	%Us	40
Average coil consumption ≤20°C		in-rush holding	W	5.4
			W	5.4
<b>Max cycles frequency</b>				
Mechanical operation			cycles/h	3600
<b>Operating times</b>				
Average time for Us control in AC	Closing NO	min	ms	8
		max	ms	24
	Opening NO	min	ms	10
		max	ms	20
	Closing NC	min	ms	14
		max	ms	28

	Opening NC	min	ms	7
		max	ms	18
in DC				
	Closing NO	min	ms	54
		max	ms	66
	Opening NO	min	ms	14
		max	ms	17

**UL technical data**

Full-load current (FLA) for three-phase AC motor	at 480V	A	7.6
	at 600V	A	0.375

Yielded mechanical performance for single-phase AC motor	110/120V	HP	0.75
	230V	HP	2
for three-phase AC motor	200/208V	HP	3
	220/230V	HP	3
	460/480V	HP	5
	575/600V	HP	7.5

General USE			
Contactor	AC current	A	25
	Short-circuit protection fuse, 600V		
High fault	Short circuit current	kA	100
	Fuse rating	A	30
	Fuse class		J
Standard fault	Short circuit current	kA	5
	Fuse rating	A	60

**Ambient conditions**

Temperature			
Operating temperature	min	°C	-50
	max	°C	70
Storage temperature	min	°C	-60
	max	°C	80
Max altitude		m	3000

**Resistance & Protection**

Pollution degree	3
------------------	---

**Dimensions**

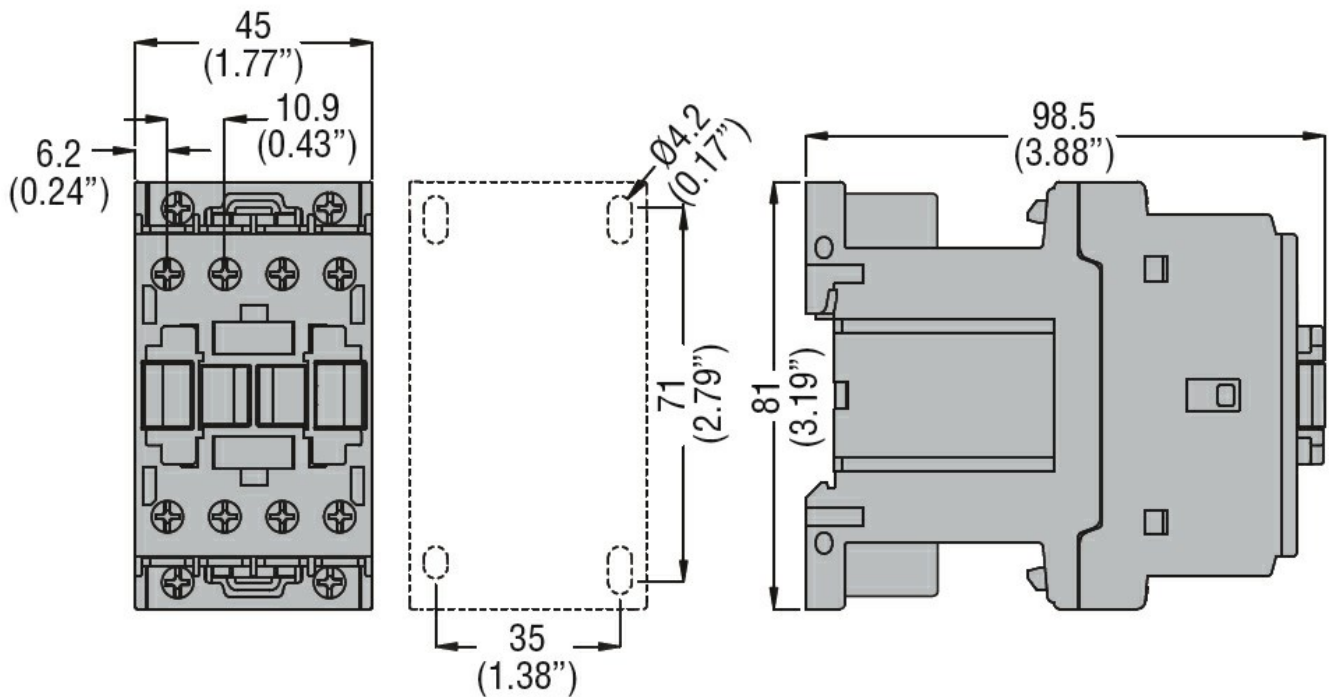

**Wiring diagrams**

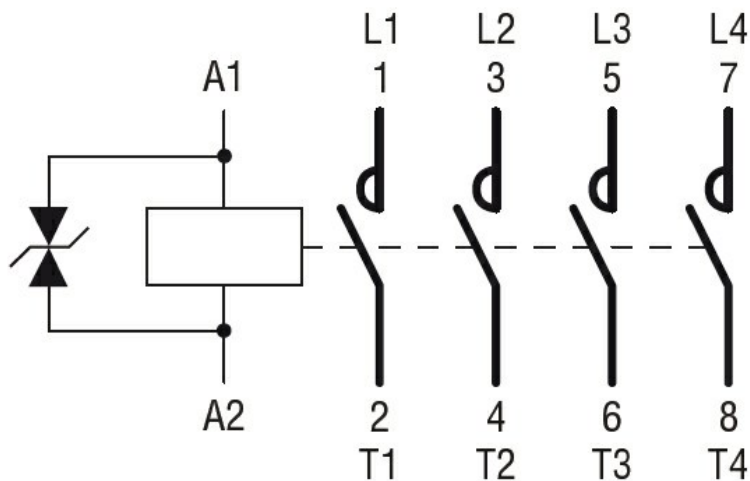

**Certifications and compliance**

**Compliance**

- CSA C22.2 n° 60947-1
- CSA C22.2 n° 60947-4-1
- IEC/EN/BS 60947-1
- IEC/EN/BS 60947-4-1
- UL 60947-1
- UL 60947-4-1

**Certificates**

- CCC
- cULus
- EAC

**ETIM classification**

ETIM 8.0

EC000066 -  
Power contactor,  
AC switching