

Modicon TM7

Digital I/O Blocks

Hardware Guide

03/2018



The information provided in this documentation contains general descriptions and/or technical characteristics of the performance of the products contained herein. This documentation is not intended as a substitute for and is not to be used for determining suitability or reliability of these products for specific user applications. It is the duty of any such user or integrator to perform the appropriate and complete risk analysis, evaluation and testing of the products with respect to the relevant specific application or use thereof. Neither Schneider Electric nor any of its affiliates or subsidiaries shall be responsible or liable for misuse of the information contained herein. If you have any suggestions for improvements or amendments or have found errors in this publication, please notify us.

You agree not to reproduce, other than for your own personal, noncommercial use, all or part of this document on any medium whatsoever without permission of Schneider Electric, given in writing. You also agree not to establish any hypertext links to this document or its content. Schneider Electric does not grant any right or license for the personal and noncommercial use of the document or its content, except for a non-exclusive license to consult it on an "as is" basis, at your own risk. All other rights are reserved.

All pertinent state, regional, and local safety regulations must be observed when installing and using this product. For reasons of safety and to help ensure compliance with documented system data, only the manufacturer should perform repairs to components.

When devices are used for applications with technical safety requirements, the relevant instructions must be followed.

Failure to use Schneider Electric software or approved software with our hardware products may result in injury, harm, or improper operating results.

Failure to observe this information can result in injury or equipment damage.

© 2018 Schneider Electric. All Rights Reserved.

Table of Contents



	Safety Information	5
	About the Book	7
Part I	TM7 System General Overview	13
Chapter 1	TM7 System General Rules for Implementing	15
	Installation Requirements	16
	Wiring Best Practices	19
	TM7 Environmental Characteristics	23
	Installation Guidelines	26
	Dimensions	33
Chapter 2	I/O Configuration General Information	35
	General Description	36
	Physical Description	38
Part II	TM7 System Digital Input Blocks	41
Chapter 3	TM7BDI8B Digital Input Block	43
3.1	TM7BDI8B Block 8DI 24 Vdc Sink	44
	TM7BDI8B Presentation	45
	TM7BDI8B Characteristics	48
	TM7BDI8B Wiring Diagram	51
Chapter 4	TM7BDI16• Digital Input Blocks	53
4.1	TM7BDI16B Block 16DI 24 Vdc Sink	54
	TM7BDI16B Presentation	55
	TM7BDI16B Characteristics	60
	TM7BDI16B Wiring Diagram	63
4.2	TM7BDI16A Block 16DI 24 Vdc Sink	64
	TM7BDI16A Presentation	65
	TM7BDI16A Characteristics	70
	TM7BDI16A Wiring Diagram	73
Part III	TM7 System Digital Output Blocks	75
Chapter 5	TM7BDO8TAB Digital Output Block	77
5.1	TM7BDO8TAB Block 8DO 24 Vdc Source	78
	TM7BDO8TAB Presentation	79
	TM7BDO8TAB Characteristics	82
	TM7BDO8TAB Wiring Diagram	86

Part IV	TM7 System Digital Mixed Input/Output Blocks	89
Chapter 6	TM7BDM8•• Digital Mixed Blocks.	91
6.1	TM7BDM8B Block 8 Configurable DI/DO 24 Vdc	92
	TM7BDM8B Presentation	93
	TM7BDM8B Characteristics.	96
	TM7BDM8B Wiring Diagram	100
Chapter 7	TM7BDM16• Digital Mixed Blocks	101
7.1	TM7BDM16A Block 16 Configurable DI/DO 24 Vdc	102
	TM7BDM16A Presentation	103
	TM7BDM16A Characteristics.	108
	TM7BDM16A Wiring Diagram	112
7.2	TM7BDM16B Block 16 Configurable DI/DO 24 Vdc	113
	TM7BDM16B Presentation	114
	TM7BDM16B Characteristics.	119
	TM7BDM16B Wiring Diagram	123
Glossary	125
Index	127

Safety Information



Important Information

NOTICE

Read these instructions carefully, and look at the equipment to become familiar with the device before trying to install, operate, service, or maintain it. The following special messages may appear throughout this documentation or on the equipment to warn of potential hazards or to call attention to information that clarifies or simplifies a procedure.



The addition of this symbol to a “Danger” or “Warning” safety label indicates that an electrical hazard exists which will result in personal injury if the instructions are not followed.



This is the safety alert symbol. It is used to alert you to potential personal injury hazards. Obey all safety messages that follow this symbol to avoid possible injury or death.

DANGER

DANGER indicates a hazardous situation which, if not avoided, **will result in** death or serious injury.

WARNING

WARNING indicates a hazardous situation which, if not avoided, **could result in** death or serious injury.

CAUTION

CAUTION indicates a hazardous situation which, if not avoided, **could result** in minor or moderate injury.

NOTICE

NOTICE is used to address practices not related to physical injury.

PLEASE NOTE

Electrical equipment should be installed, operated, serviced, and maintained only by qualified personnel. No responsibility is assumed by Schneider Electric for any consequences arising out of the use of this material.

A qualified person is one who has skills and knowledge related to the construction and operation of electrical equipment and its installation, and has received safety training to recognize and avoid the hazards involved.

QUALIFICATION OF PERSONNEL

Only appropriately trained persons who are familiar with and understand the contents of this manual and all other pertinent product documentation are authorized to work on and with this product.

The qualified person must be able to detect possible hazards that may arise from parameterization, modifying parameter values and generally from mechanical, electrical, or electronic equipment. The qualified person must be familiar with the standards, provisions, and regulations for the prevention of industrial accidents, which they must observe when designing and implementing the system.

INTENDED USE

The products described or affected by this document, together with software, accessories, and options, are expansion modules, intended for industrial use according to the instructions, directions, examples, and safety information contained in the present document and other supporting documentation.

The product may only be used in compliance with all applicable safety regulations and directives, the specified requirements, and the technical data.

Prior to using the product, you must perform a risk assessment in view of the planned application. Based on the results, the appropriate safety-related measures must be implemented.

Since the product is used as a component in an overall machine or process, you must ensure the safety of persons by means of the design of this overall system.

Operate the product only with the specified cables and accessories. Use only genuine accessories and spare parts.

Any use other than the use explicitly permitted is prohibited and can result in unanticipated hazards.

About the Book



At a Glance

Document Scope

This manual describes the hardware implementation of the Modicon TM7 Digital I/O blocks. It provides parts descriptions, specifications, wiring diagrams, installation and setup for Modicon TM7 Digital I/O blocks.

Validity Note

This document has been updated for the release of TM3TI4D Add-on for SoMachine V4.3.

The technical characteristics of the devices described in this document also appear online. To access this information online:

Step	Action
1	Go to the Schneider Electric home page www.schneider-electric.com .
2	In the Search box type the reference of a product or the name of a product range. <ul style="list-style-type: none">• Do not include blank spaces in the reference or product range.• To get information on grouping similar modules, use asterisks (*).
3	If you entered a reference, go to the Product Datasheets search results and click on the reference that interests you. If you entered the name of a product range, go to the Product Ranges search results and click on the product range that interests you.
4	If more than one reference appears in the Products search results, click on the reference that interests you.
5	Depending on the size of your screen, you may need to scroll down to see the data sheet.
6	To save or print a data sheet as a .pdf file, click Download XXX product datasheet .

The characteristics that are presented in this manual should be the same as those characteristics that appear online. In line with our policy of constant improvement, we may revise content over time to improve clarity and accuracy. If you see a difference between the manual and online information, use the online information as your reference.

Related Documents

Title of Documentation	Reference Number
Modicon TM7 Expansion Blocks Configuration Programming Guide	EIO0000000880(Eng); EIO0000000881 (Fre); EIO0000000882 (Ger); EIO0000000883(Spa); EIO0000000884 (Ita); EIO0000000885 (Chs)
Modicon M258 Logic Controller Programming Guide	EIO0000000402 (Eng); EIO0000000403 (Fre); EIO0000000404 (Ger); EIO0000000405 (Spa); EIO0000000406 (Ita); EIO0000000407 (Chs)
Modicon LMC058 Motion Controller Programming Guide	EIO0000000408 (Eng); EIO0000000409 (Fre); EIO0000000410 (Ger); EIO0000000411 (Spa); EIO0000000412 (Ita); EIO0000000413 (Chs)
Modicon TM5 / TM7 Flexible System - System Planning and Installation Guide	EIO0000000426 (Eng); EIO0000000427 (Fre); EIO0000000428 (Ger); EIO0000000429 (Spa); EIO0000000430 (Ita); EIO0000000431 (Chs)
Modicon M258 Logic Controller Hardware Guide	EIO0000000432 (Eng); EIO0000000433 (Fre); EIO0000000434 (Ger); EIO0000000435 (Spa); EIO0000000436 (Ita); EIO0000000437 (Chs)
Modicon LMC058 Motion Controller Hardware Guide	EIO0000000438 (Eng); EIO0000000439 (Fre); EIO0000000440 (Ger); EIO0000000441 (Spa); EIO0000000442 (Ita); EIO0000000443 (Chs)
TM7 Digital I/O Blocks Instruction Sheet	S1A33621

You can download these technical publications and other technical information from our website at <https://www.schneider-electric.com/en/download>

Product Related Information

DANGER

HAZARD OF ELECTRIC SHOCK, EXPLOSION OR ARC FLASH

- Disconnect all power from all equipment including connected devices prior to removing any covers or doors, or installing or removing any accessories, hardware, cables, or wires except under the specific conditions specified in the appropriate hardware guide for this equipment.
- Always use a properly rated voltage sensing device to confirm the power is off where and when indicated.
- Replace and secure all covers, accessories, hardware, cables, and wires and confirm that a proper ground connection exists before applying power to the unit.
- Use only the specified voltage when operating this equipment and any associated products.

Failure to follow these instructions will result in death or serious injury.

DANGER

POTENTIAL FOR EXPLOSION

- Use devices with explosion protection as intended according to these operation instructions and corresponding documents.
- Conform to valid safety and accident prevention regulations and adhere to standards such as IEC/EN 60079-14.
- Be sure that all other associated equipment, such as cables and connectors, are also suitable for the operating location.
- Ground all devices, using a metal plate, terminal strip or mounting plate securely connected to the housing back plate, to an equalized potential.
- Disconnect all power from all equipment including connected devices prior to removing any covers or doors, or installing or removing any accessories, hardware, cables, or wires except under the specific conditions specified in the appropriate hardware guide for this equipment.
- Devices must remain voltage free until all installation or maintenance work is completed.
- Remove as necessary dust collecting on devices that can cause explosions.
- Be sure that all connectors and sealing plugs on the M8 and M12 connectors are in place and fastened with a torque between 0.2 and 0.4 Nm (1.8 and 3.5 lbf-in) before applying any power.
- Be sure that all connectors are firmly sealed with either properly wired connectors or sealing plugs before applying power during regular operation.

Failure to follow these instructions will result in death or serious injury.

DANGER

POTENTIAL FOR EXPLOSION

- Only use this equipment in non-hazardous locations or in locations that comply either with the Class I, Division 2, Groups A, B, C and D, or with the ATEX Group II, Zone 2 specifications for hazardous locations, depending on your local and/or national regulations.
- Do not substitute components which would impair compliance to the hazardous location specifications of this equipment.
- Do not connect or disconnect equipment unless power has been removed or the location is known to be non-hazardous.

Failure to follow these instructions will result in death or serious injury.

NOTE: Additional equipment used in conjunction with the equipment described herein must also be suitable for the operating location.

WARNING

LOSS OF CONTROL

- The designer of any control scheme must consider the potential failure modes of control paths and, for certain critical control functions, provide a means to achieve a safe state during and after a path failure. Examples of critical control functions are emergency stop and overtravel stop, power outage and restart.
- Separate or redundant control paths must be provided for critical control functions.
- System control paths may include communication links. Consideration must be given to the implications of unanticipated transmission delays or failures of the link.
- Observe all accident prevention regulations and local safety guidelines.¹
- Each implementation of this equipment must be individually and thoroughly tested for proper operation before being placed into service.

Failure to follow these instructions can result in death, serious injury, or equipment damage.

¹ For additional information, refer to NEMA ICS 1.1 (latest edition), "Safety Guidelines for the Application, Installation, and Maintenance of Solid State Control" and to NEMA ICS 7.1 (latest edition), "Safety Standards for Construction and Guide for Selection, Installation and Operation of Adjustable-Speed Drive Systems" or their equivalent governing your particular location.

WARNING

UNINTENDED EQUIPMENT OPERATION

- Only use software approved by Schneider Electric for use with this equipment.
- Update your application program every time you change the physical hardware configuration.

Failure to follow these instructions can result in death, serious injury, or equipment damage.

Terminology Derived from Standards

The technical terms, terminology, symbols and the corresponding descriptions in this manual, or that appear in or on the products themselves, are generally derived from the terms or definitions of international standards.

In the area of functional safety systems, drives and general automation, this may include, but is not limited to, terms such as *safety*, *safety function*, *safe state*, *fault*, *fault reset*, *malfunction*, *failure*, *error*, *error message*, *dangerous*, etc.

Among others, these standards include:

Standard	Description
EN 61131-2:2007	Programmable controllers, part 2: Equipment requirements and tests.
ISO 13849-1:2008	Safety of machinery: Safety related parts of control systems. General principles for design.
EN 61496-1:2013	Safety of machinery: Electro-sensitive protective equipment. Part 1: General requirements and tests.
ISO 12100:2010	Safety of machinery - General principles for design - Risk assessment and risk reduction
EN 60204-1:2006	Safety of machinery - Electrical equipment of machines - Part 1: General requirements
EN 1088:2008 ISO 14119:2013	Safety of machinery - Interlocking devices associated with guards - Principles for design and selection
ISO 13850:2006	Safety of machinery - Emergency stop - Principles for design
EN/IEC 62061:2005	Safety of machinery - Functional safety of safety-related electrical, electronic, and electronic programmable control systems
IEC 61508-1:2010	Functional safety of electrical/electronic/programmable electronic safety-related systems: General requirements.
IEC 61508-2:2010	Functional safety of electrical/electronic/programmable electronic safety-related systems: Requirements for electrical/electronic/programmable electronic safety-related systems.
IEC 61508-3:2010	Functional safety of electrical/electronic/programmable electronic safety-related systems: Software requirements.
IEC 61784-3:2008	Digital data communication for measurement and control: Functional safety field buses.

Standard	Description
2006/42/EC	Machinery Directive
2014/30/EU	Electromagnetic Compatibility Directive
2014/35/EU	Low Voltage Directive

In addition, terms used in the present document may tangentially be used as they are derived from other standards such as:

Standard	Description
IEC 60034 series	Rotating electrical machines
IEC 61800 series	Adjustable speed electrical power drive systems
IEC 61158 series	Digital data communications for measurement and control – Fieldbus for use in industrial control systems

Finally, the term *zone of operation* may be used in conjunction with the description of specific hazards, and is defined as it is for a *hazard zone* or *danger zone* in the *Machinery Directive (2006/42/EC)* and *ISO 12100:2010*.

NOTE: The aforementioned standards may or may not apply to the specific products cited in the present documentation. For more information concerning the individual standards applicable to the products described herein, see the characteristics tables for those product references.

Part I

TM7 System General Overview

What Is in This Part?

This part contains the following chapters:

Chapter	Chapter Name	Page
1	TM7 System General Rules for Implementing	15
2	I/O Configuration General Information	35

Chapter 1

TM7 System General Rules for Implementing

What Is in This Chapter?

This chapter contains the following topics:

Topic	Page
Installation Requirements	16
Wiring Best Practices	19
TM7 Environmental Characteristics	23
Installation Guidelines	26
Dimensions	33

Installation Requirements

Before Starting

Read and understand this chapter before beginning the installation of your TM7 System.

DANGER

POTENTIAL FOR EXPLOSION

- Use devices with explosion protection as intended according to these operation instructions and corresponding documents.
- Conform to valid safety and accident prevention regulations and adhere to standards such as IEC/EN 60079-14.
- Be sure that all other associated equipment, such as cables and connectors, are also suitable for the operating location.
- Ground all devices, using a metal plate, terminal strip or mounting plate securely connected to the housing back plate, to an equalized potential.
- Disconnect all power from all equipment including connected devices prior to removing any covers or doors, or installing or removing any accessories, hardware, cables, or wires except under the specific conditions specified in the appropriate hardware guide for this equipment.
- Devices must remain voltage free until all installation or maintenance work is completed.
- Remove as necessary dust collecting on devices that can cause explosions.
- Be sure that all connectors and sealing plugs on the M8 and M12 connectors are in place and fastened with a torque between 0.2 and 0.4 Nm (1.8 and 3.5 lbf-in) before applying any power.
- Be sure that all connectors are firmly sealed with either properly wired connectors or sealing plugs before applying power during regular operation.

Failure to follow these instructions will result in death or serious injury.

NOTICE

ELECTROSTATIC DISCHARGE

- Do not touch the pin connectors of the block.
- Keep the cables or sealing plugs in place during normal operation.

Failure to follow these instructions can result in equipment damage.

Programming Considerations

WARNING

UNINTENDED EQUIPMENT OPERATION

- Only use software approved by Schneider Electric for use with this equipment.
- Update your application program every time you change the physical hardware configuration.

Failure to follow these instructions can result in death, serious injury, or equipment damage.

Operating Environment

DANGER

POTENTIAL FOR EXPLOSION

- Only use this equipment in non-hazardous locations or in locations that comply either with the Class I, Division 2, Groups A, B, C and D, or with the ATEX Group II, Zone 2 specifications for hazardous locations, depending on your local and/or national regulations.
- Do not substitute components which would impair compliance to the hazardous location specifications of this equipment.
- Do not connect or disconnect equipment unless power has been removed or the location is known to be non-hazardous.

Failure to follow these instructions will result in death or serious injury.

NOTE: Additional equipment used in conjunction with the equipment described herein must also be suitable for the operating location.

Requirements for use in ATEX Group II, Zone 2:

- Install and use the equipment strictly in accordance to the installation and operating instructions found here and in other related documentation.
- Respect and follow all valid safety and accident prevention regulations, as well as adhering to standards such as IEC/EN 60079-14 or those that govern the eventual locality of your application.
- All equipment must be grounded to an equipotential ground plane dimensioned to the power system of your application.
- Equipment must remain unpowered until installation work is completed, including all cable connections with the proper torque having been applied to all connector unions.
- Before applying power, be sure that all connectors that are not being used (open connectors with no cable attached) are capped with suitable sealing plugs.
- During service or maintenance, the equipment must be shut down and protected from being accidentally restarted.
- Do not connect or disconnect cables or sealing plugs under power unless the equipment is in a known non-hazardous location.

 **WARNING**

UNINTENDED EQUIPMENT OPERATION

Install and operate this equipment according to the conditions described in the Environmental Characteristics.

Failure to follow these instructions can result in death, serious injury, or equipment damage.

Installation Considerations

 **WARNING**

UNINTENDED EQUIPMENT OPERATION

- Use appropriate safety interlocks where personnel and/or equipment hazards exist.
- Install and operate this equipment in an enclosure appropriately rated for its intended environment and secured by a keyed or tooled locking mechanism.
- Use the sensor and actuator power supplies only for supplying power to the sensors or actuators connected to the module.
- Power line and output circuits must be wired and fused in compliance with local and national regulatory requirements for the rated current and voltage of the particular equipment.
- Do not use this equipment in safety-critical machine functions unless the equipment is otherwise designated as functional safety equipment and conforming to applicable regulations and standards.
- Do not disassemble, repair, or modify this equipment.
- Do not connect any wiring to reserved, unused connections, or to connections designated as No Connection (N.C.).

Failure to follow these instructions can result in death, serious injury, or equipment damage.

NOTE: Use UL-recognized and CSA approved JDYX2 or JDYX8 fuse types.

Wiring Best Practices

Introduction

There are several rules that must be followed when wiring a TM7 System. Refer to TM7 Cables (*see Modicon TM5 / TM7 Flexible System, System Planning and Installation Guide*) for additional details.

Wiring Rules

DANGER

HAZARD OF ELECTRIC SHOCK, EXPLOSION OR ARC FLASH

- Disconnect all power from all equipment including connected devices prior to removing any covers or doors, or installing or removing any accessories, hardware, cables, or wires except under the specific conditions specified in the appropriate hardware guide for this equipment.
- Always use a properly rated voltage sensing device to confirm the power is off where and when indicated.
- Replace and secure all covers, accessories, hardware, cables, and wires and confirm that a proper ground connection exists before applying power to the unit.
- Use only the specified voltage when operating this equipment and any associated products.

Failure to follow these instructions will result in death or serious injury.

The following rules must be applied when wiring the TM7 System:

- I/O and communication wiring must be kept separate from the power wiring. Route these 2 types of wiring in separate cable ducting.
- Verify that the operating conditions and environment are within the specification values.
- Use proper wire sizes to meet voltage and current requirements.
- Use copper conductors only.
- Use only the TM7 expansion bus cables (*see Modicon TM5 / TM7 Flexible System, System Planning and Installation Guide*).

TM7 Blocks Grounding

The TM7 System blocks, when using Schneider Electric IP67 pre-fabricated cables, incorporate a grounding system intrinsic to the mounting and connecting hardware. The TM7 System blocks must always be mounted on a conductive backplane. The backplane or object used for mounting the blocks (metal machine frame, mounting rail or mounting plate) must be grounded (PE) according to your local, regional and national requirements and regulations. Refer to grounding of your system blocks (*see Modicon TM5 / TM7 Flexible System, System Planning and Installation Guide*), for more important information.

NOTE: If you do not use Schneider Electric IP67 pre-fabricated cables, you must use shielded cables and conductive connectors (metal threads on the connector), and be sure to connect the cable shield to the metal sleeve of the connector.

⚠ WARNING

IMPROPER GROUNDING CONTINUITY

- Use only cables with insulated, shielded jackets.
- Use only IP67 connectors with metal threads.
- Connect the cable shield to the metal threads of the connectors.
- Always comply with local, regional and/or national wiring requirements.

Failure to follow these instructions can result in death, serious injury, or equipment damage.

The following figure presents the grounding of the TM7 System:

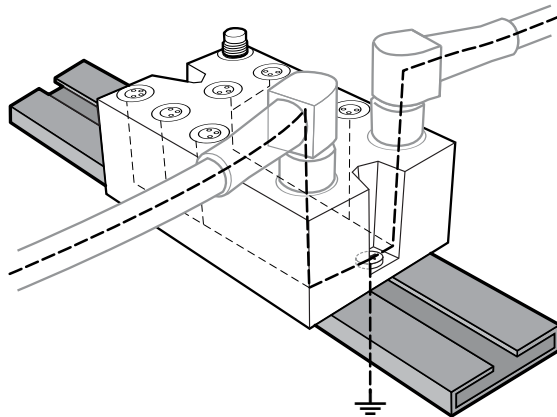

Protecting Outputs from Inductive Load Damage

Depending on the load, a protection circuit may be needed for the outputs on certain blocks. Inductive loads using DC voltages may create voltage reflections resulting in overshoot that will damage or shorten the life of output devices.

NOTICE

INOPERABLE EQUIPMENT

- Be sure that the actuators connected to the TM7 Digital I/O blocks have a built-in protective circuit to reduce the risk of inductive current load damage to the outputs.
- If the actuators do not have built-in protection, use an appropriate, IP67 rated external protective circuit to reduce the risk of inductive current load damage to the outputs.

Failure to follow these instructions can result in equipment damage.

NOTE: The following wiring diagrams are conceptual and are provided as non-definitive guidance for selecting an appropriate IP67 protective device.

Protective circuit A: this protection circuit can be used for DC load power circuits.

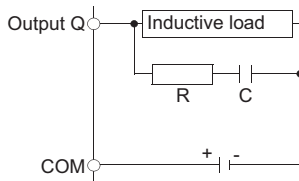

- C represents a value from 0.1 to 1 μF .
- R represents a resistor of approximately the same resistance value as the load.

Protective circuit B: this protection circuit can be used for DC load power circuits.

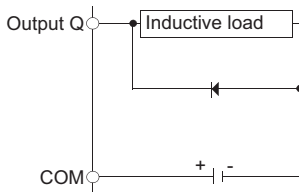

Use a diode with the following ratings:

- Reverse withstand voltage: power voltage of the load circuit x 10.
- Forward current: more than the load current.

Protective circuit C: this protection circuit can be used for DC load power circuits.

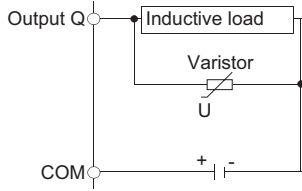

In applications where the inductive load is switched on and off frequently and/or rapidly, ensure that the continuous energy rating (J) of the varistor exceeds the peak load energy by 20% or more.

TM7 Environmental Characteristics

Introduction

The following information describes the system-wide environmental requirements and characteristics for the TM7 System.

Environmental Characteristics

This equipment meets UL, CSA, and CE requirements as indicated in the following table. This equipment is intended for use in a Pollution Degree 2 industrial environment.

The table below provides the general environmental characteristics:

Characteristic	Specification	
	II 3G	Device group II, Category 3, Zone 2 suitable for explosive gas
	Ex	Protection according to European standards
	nA	Ignition protection "n"
	IIA	Gas group
	T5	Temperature class
	Gc	Equipment protection level (EPL)
	84 °C (183 °F)	Maximum surface temperature
	IP67	Protection index according to EN/IEC 60529
	Ta = 0...60 °C (32...140 °F)	Ambient temperature range
	TÜV 10 ATEX 7939 X	Certificate number
Standard	IEC61131-2	
Agencies	UL 508 CSA 22.2 No. 142-M1987 CSA 22.2 No. 213-M1987	
Ambient operating temperature	0...60 °C (32...140 °F)	
Storage temperature	-25...85 °C (-13...185 °F)	
Relative humidity	5...95% (non-condensing)	
Pollution degree	IEC60664	2 (non-conductive material)
Protection degree	EN/IEC60529	IP67
Operating altitude	0...2000 m (0...6560 ft.)	
	2000...3000 m (6560...9842 ft.) ⁽¹⁾	
(1) Reduction of ambient temperature by 0.5 °C (0.9 °F) for every additional 100 m (328 ft.) of altitude beyond 2000 m (6560 ft.).		

Characteristic	Specification	
Vibration resistance	IEC60721-3-5 Class 5M3	7.5 mm (0.295 in.) fixed amplitude from 2...8 Hz 20 m/s ² (2 g _n) fixed acceleration from 8...200 Hz 40 m/s ² (4 g _n) fixed acceleration from 200...500 Hz
Mechanical shock resistance	IEC60721-3-5 Class 5M3	300 m/s ² (30 g _n) for a duration of 11 ms, half sine wave, shock type 1
Connection type		M8 or M12 depending on the I/O block
(1) Reduction of ambient temperature by 0.5 °C (0.9 °F) for every additional 100 m (328 ft.) of altitude beyond 2000 m (6560 ft.).		

Electromagnetic Susceptibility

The table below provides the TM7 System electromagnetic susceptibility specifications:

Characteristic	Specification	Range
Electrostatic discharge	EN/IEC 61000-4-2	± 8 kV, criteria B (air discharge) ± 6 kV, criteria B (contact discharge)
Electromagnetic fields	EN/IEC 61000-4-3	10 V/m, 80% amplitude modulation at 1 kHz (80 MHz...2 GHz) 1 V/m (2...2.7 GHz)
Fast transients burst	EN/IEC 61000-4-4	Power lines: 2 kV, criteria B I/O: 1 kV, criteria B Shielded cable: 1 kV, criteria B Repetition rate: 5 and 100 kHz
Surge immunity 24 Vdc circuit	EN/IEC 61000-4-5	Power lines: 1 kV (12 Ω), criteria B in common mode 0.5 kV (2 Ω), criteria B in differential mode
		Unshielded lines: 0.5 kV (42 Ω), criteria B in common mode 1 kV (42 Ω), criteria B in differential mode
		Shielded lines: 1 kV (12 Ω), criteria B in common mode 0.5 kV (2 Ω), criteria B in differential mode
Induced electromagnetic field	EN/IEC 61000-4-6	Network, I/O signal connections > 10 m (32.8 ft.), functional ground connection: 10 V _{eff} , criteria A, 80% amplitude modulation at 1 kHz (150...80 MHz)
Criteria A Uninterrupted operation during test. Criteria B Brief interruption during the test allowed.		

Characteristic	Specification	Range
Conducted emission	EN 55011 (IEC/CISPR11)	150...500 kHz quasi peak 79 dB μ V
		500 kHz...30 MHz quasi peak 73 dB μ V
Radiated emission	EN 55011 (IEC/CISPR11)	30...230 MHz, 10 m (32.8 ft)@40 dB (μ V/m)
		230 MHz...1 GHz, 10 m (32.8 ft)@47 dB (μ V/m)
Criteria A Uninterrupted operation during test. Criteria B Brief interruption during the test allowed.		

Conformity and Test Certification

These devices were developed and tested according to valid European guidelines and standards. Modules labeled ATEX meet the following EU guidelines:

Characteristic	Specification
Electromagnetic compatibility (EMC)	2004/108/EC
Low voltage (LV)	2006/95/EC
Equipment explosive atmospheres (ATEX)	94/9/EC
Standards met	EN 61131-2, EN 61000-6-2, EN 61000-6-4, EN 60204-1, EN 50178, EN 60079-15

Installation Guidelines

Introduction

The TM7 System can be mounted using:

- An aluminium frame with two wedge nuts and M4 screws
- A DIN rail with TM7ACMP mounting plate
- Directly on the machine.

NOTE: Mounting on a DIN rail using the TM7ACMP mounting plate is only possible with the size 1 (smallest) block dimension (see *Modicon TM5 / TM7 Flexible System, System Planning and Installation Guide*).

NOTE: The TM7 System components must always be mounted to a conductive backplane.

TM7 Block on an Aluminium Frame

Blocks can be mounted on an aluminium frame with two wedge nuts and M4 screws:

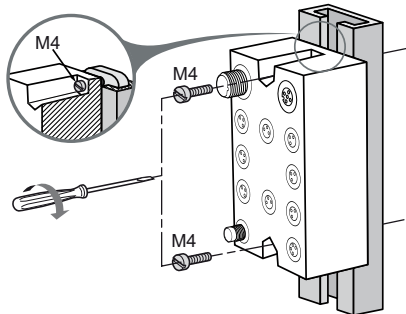

NOTE: Maximum torque to fasten the M4 screws is 0.6 N.m (5.3 lbf-in).

NOTICE

INOPERABLE EQUIPMENT

- Ensure that the block is securely affixed to its mounting surface.
- Do not tighten screws beyond the specified maximum torque.

Failure to follow these instructions can result in equipment damage.

TM7 Block on a DIN Rail

You can mount the size 1 blocks on a DIN rail with the TM7ACMP (see *Modicon TM5 / TM7 Flexible System, System Planning and Installation Guide*) mounting plate. For EMC (Electromagnetic Compatibility) compliance, a metal DIN rail must be attached to a flat metal mounting surface or mounted on an EIA (Electronic Industries Alliance) rack or in a NEMA (National Electrical Manufacturers Association) enclosure. In all cases, the mounting surface must be properly grounded (see *Modicon TM5 / TM7 Flexible System, System Planning and Installation Guide*).

You can order a suitable DIN rail from Schneider Electric:

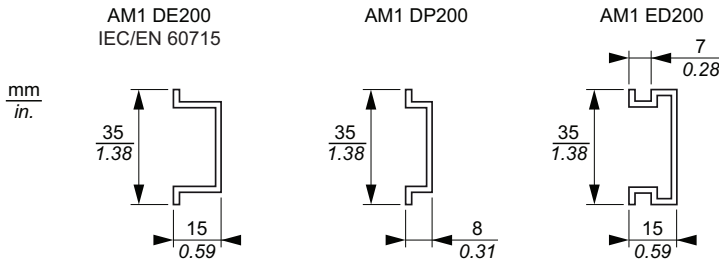

NOTE: Only size 1 (smallest) blocks can be installed on DIN rail with the mounting plate.

The following procedure gives step by step instructions to assemble and install a block on a DIN rail:

Step	Action	
1	<p>Screw the block to the mounting plate. The required screws are supplied with the mounting plate.</p> <p>NOTE: Maximum torque to fasten the required screws is 0.6 Nm (5.3 lbf-in).</p>	

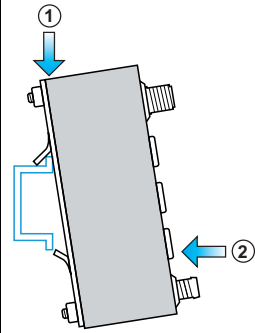
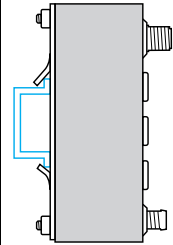
Step	Action
2	<p>Place the upper protruding catches of the mounting plate on the top edge of the DIN rail (1). Rotate the block to the DIN rail until it clicks (2).</p> 
3	<p>The block is correctly installed to the DIN rail</p> 

NOTICE

INOPERABLE EQUIPMENT

- Ensure that the block is securely affixed to its mounting surface.
- Do not tighten screws beyond the specified maximum torque.

Failure to follow these instructions can result in equipment damage.

For more information on mounting the DIN rail refer to the TM5 section DIN Rail Installation (see *Modicon TM5 / TM7 Flexible System, System Planning and Installation Guide*).

TM7 Block Directly on the Machine

The TM7 block can be mounted to any bare-metal surface of the machine, provided that the surface is properly grounded (*see Modicon TM5 / TM7 Flexible System, System Planning and Installation Guide*). To mount the block directly on the machine, the following figure gives the drilling template of the blocks:

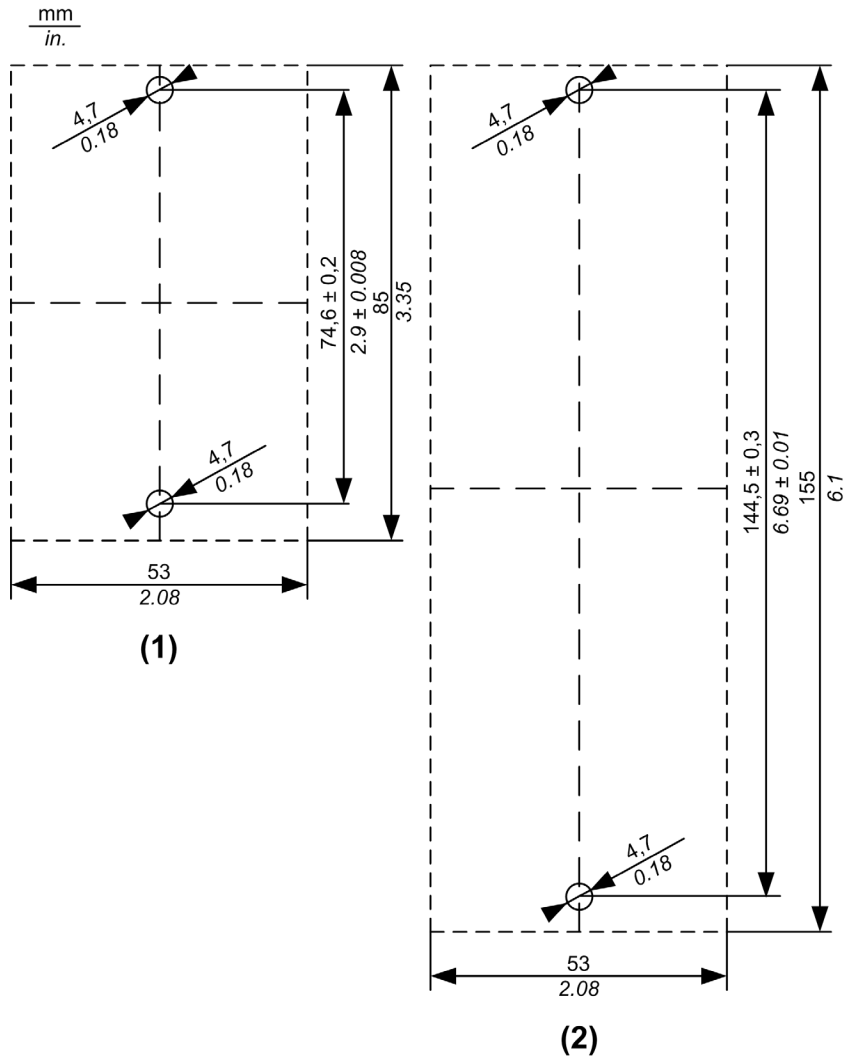

- (1) Size 1 block
- (2) Size 2 block

The thickness of the base plate should be taken into consideration when defining the screw length.

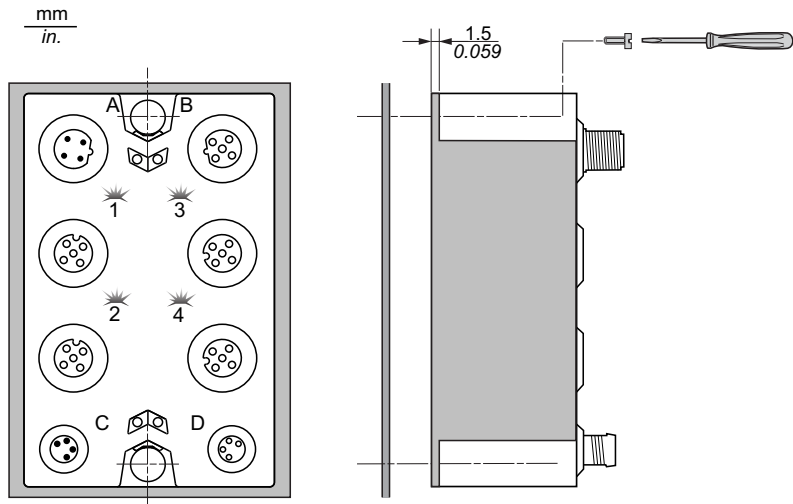

NOTE: Maximum torque to fasten the required M4 screws is 0.6 Nm (5.3 lbf-in).

NOTICE

INOPERABLE EQUIPMENT

- Ensure that the block is securely affixed to its mounting surface.
- Do not tighten screws beyond the specified maximum torque.

Failure to follow these instructions can result in equipment damage.

TM7 Cable Installation

The plug connector of the TM7 cables (*see Modicon TM5 / TM7 Flexible System, System Planning and Installation Guide*) is mounted by hand and then tightened to a defined force with the aid of the torque wrench (*see Modicon TM5 / TM7 Flexible System, System Planning and Installation Guide*):

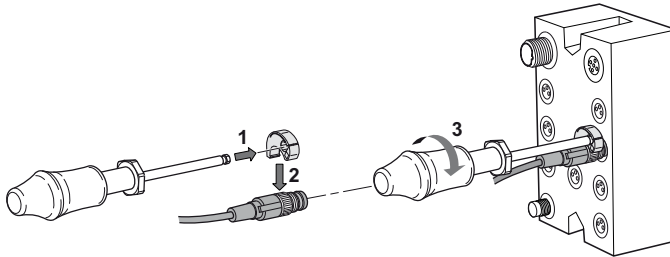

Connector Size	Torque
M8	0.2 Nm (1.8 lbf-in)
M12	0.4 Nm (3.5 lbf-in)

⚠ WARNING

IP67 NON-CONFORMANCE

- Properly fit all connectors with cables or sealing plugs and tighten for IP67 conformance according to the torque values as specified in this document.
- Do not connect or disconnect cables or sealing plugs in the presence of water or moisture.

Failure to follow these instructions can result in death, serious injury, or equipment damage.

Sealing Plug Installation

Open connectors with no cable attached are capped with suitable sealing plugs (see *Modicon TM5 / TM7 Flexible System, System Planning and Installation Guide*):

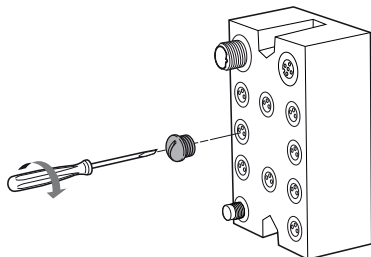

Connector Size	Torque
M8	0.2 Nm (1.8 lbf-in)
M12	0.4 Nm (3.5 lbf-in)

⚠ WARNING

IP67 NON-CONFORMANCE

- Properly fit all connectors with cables or sealing plugs and tighten for IP67 conformance according to the torque values as specified in this document.
- Do not connect or disconnect cables or sealing plugs in the presence of water or moisture.

Failure to follow these instructions can result in death, serious injury, or equipment damage.

TM7 Block Labeling

The support for block label and its label are inserted in the appropriate opening in the top (the figure below) or in the bottom of the block:

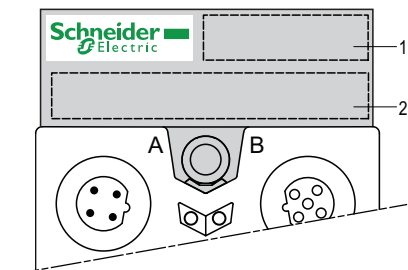

- 1 Reference of the block
- 2 Area for customer

Dimensions

Dimensions

The following figures show the dimensions of the TM7 blocks:

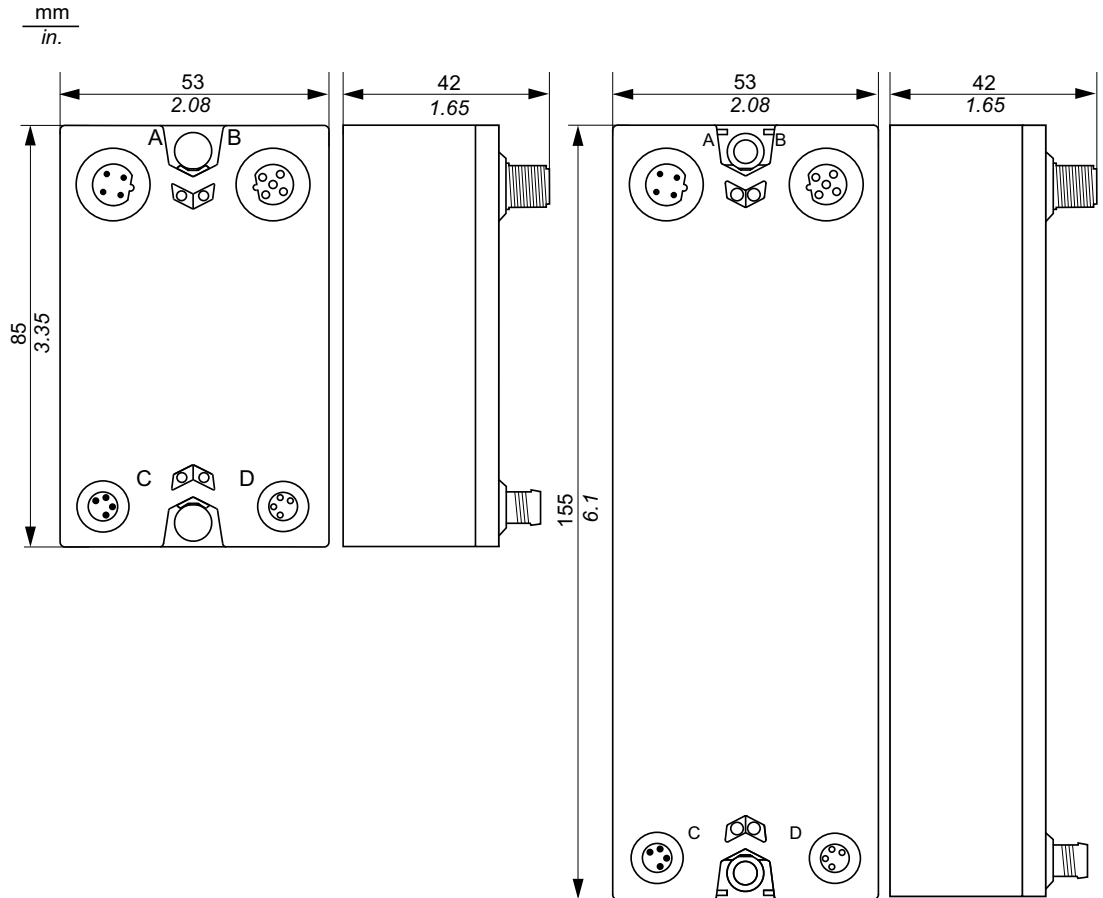

Chapter 2

I/O Configuration General Information

Introduction

This chapter provides the general considerations to configure I/O expansion blocks.

What Is in This Chapter?

This chapter contains the following topics:

Topic	Page
General Description	36
Physical Description	38

General Description

Introduction

The range of TM7 Digital I/O blocks includes:

- Digital input blocks
- Digital output blocks
- Digital mixed input/output blocks

The TM7 Digital I/O blocks need to be associated with IP67 power cables, TM7 bus cables and I/O cables.

Digital Input Block Features

Digital inputs convert the electronic input signal into a binary value which can be processed by the controller. The following table shows the digital input block features, with corresponding channel type and voltage/current:

Reference	Number of Channels	Voltage/Current	Wiring	Signal type
TM7BDI8B <i>(see page 45)</i>	8	24 Vdc/7 mA	M8 connectors 2 or 3 wires	Sink
TM7BDI16B <i>(see page 55)</i>	16	24 Vdc/7 mA	M8 connectors 2 or 3 wires	Sink
TM7BDI16A <i>(see page 65)</i>	16	24 Vdc/7 mA	M12 connectors 2 or 3 wires	Sink

Digital Output Blocks Features

Digital outputs convert the binary value from the controller into an electronic output signal. The following table shows the digital output I/O block features, with corresponding channel type and voltage/current:

Reference	Number of Channels	Voltage/Current	Wiring	Signal type
TM7BDOTAB <i>(see page 79)</i>	8	24 Vdc/2 A max.	M8 connector 2 or 3 wires	Transistor source

Digital Mixed Blocks Features

The following table shows the digital mixed I/O block features, with corresponding channel type and voltage/current:

Reference	Number of Channels	Voltage/Current	Wiring	Signal type
TM7BDM8B <i>(see page 93)</i>	8 configurable I/O, any mix	24 Vdc/4.4 mA	M8 connector 2 or 3 wires	Sink
		24 Vdc/0.5 A max.	M8 connector 2 or 3 wires	Transistor source
TM7BDM16A <i>(see page 103)</i>	16 inputs	24 Vdc/4.4 mA	M12 connector 2 or 3 wires	Sink
	16 outputs	24 Vdc/0.5 A max.	M12 connector 2 or 3 wires	Transistor source
TM7BDM16B <i>(see page 114)</i>	16 inputs	24 Vdc/4.4 mA	M8 connector 2 or 3 wires	Sink
	16 outputs	24 Vdc/0.5 A max.	M8 connector 2 or 3 wires	Transistor source

Physical Description

Introduction

The TM7 System consists of IP67 I/O blocks along with field bus, expansion, sensor/actuator and power cables.

A TM7 I/O block can be a:

- digital I/O block,
- analog I/O block, for details, refer to the *Modicon TM7 Analog I/O Blocks Hardware Guide*
- Power Distribution Block (PDB), for details, refer to the chapter *TM7SPS1A Power Distribution Block (PDB)* in the *Modicon TM5 / TM7 Flexible System - System Planning and Installation Guide*

General View of a TM7 I/O Block and Cables

The following figure shows a TM7 I/O block and associated cables:

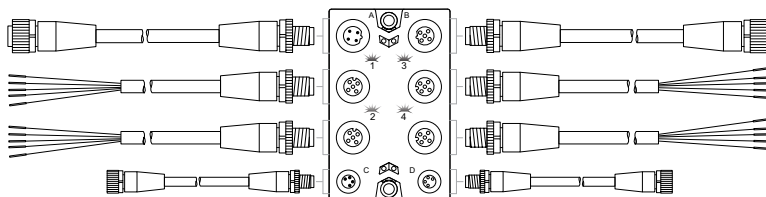

Item	TM7 Cable Type	TM7 Block Connector
A	Expansion bus drop cable	TM7 bus IN
B	Expansion bus drop cable	TM7 bus OUT
1...4	Sensor or actuator cable	I/O connectors
C	Power drop cable	24 Vdc power IN connector
D	Power drop cable	24 Vdc power OUT connector

⚠ WARNING

IP67 NON-CONFORMANCE

- Properly fit all connectors with cables or sealing plugs and tighten for IP67 conformance according to the torque values as specified in this document.
- Do not connect or disconnect cables or sealing plugs in the presence of water or moisture.

Failure to follow these instructions can result in death, serious injury, or equipment damage.

NOTICE

ELECTROSTATIC DISCHARGE

- Do not touch the pin connectors of the block.
- Keep the cables or sealing plugs in place during normal operation.

Failure to follow these instructions can result in equipment damage.

TM7 Cables References

Refer to TM7 Cables (*see Modicon TM5 / TM7 Flexible System, System Planning and Installation Guide*), for more information on the type and length of cables, along with their references.

TM7 I/O Blocks Pin and Connector Assignments

The following figure shows the connector assignments of a TM7 I/O block:

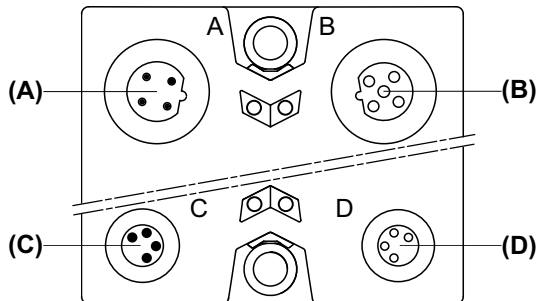

- (A) TM7 bus IN connector M12
- (B) TM7 bus OUT connector M12
- (C) 24 Vdc power IN connector M8
- (D) 24 Vdc power OUT connector M8

The following figure shows the pin assignments of the TM7 bus IN (A) and OUT (B) connectors:

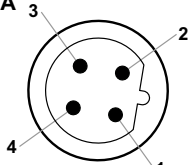
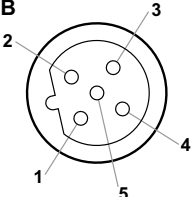
Connection	Pin	Designation
	1	TM7 V+
	2	TM7 Bus Data
	3	TM7 0 Vdc
	4	TM7 Bus $\overline{\text{Data}}$
	5	N.C.
		

The following figure shows the pin assignments of the 24 Vdc power IN (C) and OUT (D) connectors:

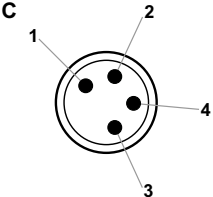
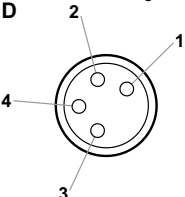
Connection	Pin	Designation
	1	24 Vdc I/O power segment
	2	24 Vdc I/O power segment
	3	0 Vdc
	4	0 Vdc
		

NOTE:

- The status of the LEDs are provided in the *Presentation* section of each I/O block.
- The pin assignments of the I/O connectors are provided in the *Wiring Diagram* section of each I/O block.

Part II

TM7 System Digital Input Blocks

What Is in This Part?

This part contains the following chapters:

Chapter	Chapter Name	Page
3	TM7BDI8B Digital Input Block	43
4	TM7BDI16• Digital Input Blocks	53

Chapter 3

TM7BDI8B Digital Input Block

Section 3.1

TM7BDI8B Block 8DI 24 Vdc Sink

What Is in This Section?

This section contains the following topics:

Topic	Page
TM7BDI8B Presentation	45
TM7BDI8B Characteristics	48
TM7BDI8B Wiring Diagram	51

TM7BDI8B Presentation

Main Characteristics

The table below provides the main characteristics of the TM7BDI8B block:

Main characteristics	
Number of input channels	8
Input type	Type 1
Signal type	Sink
Rated input voltage	24 Vdc
Sensor connection type	M8, female connector type <i>(see page 51)</i>

Description

The following figure shows the TM7BDI8B block:

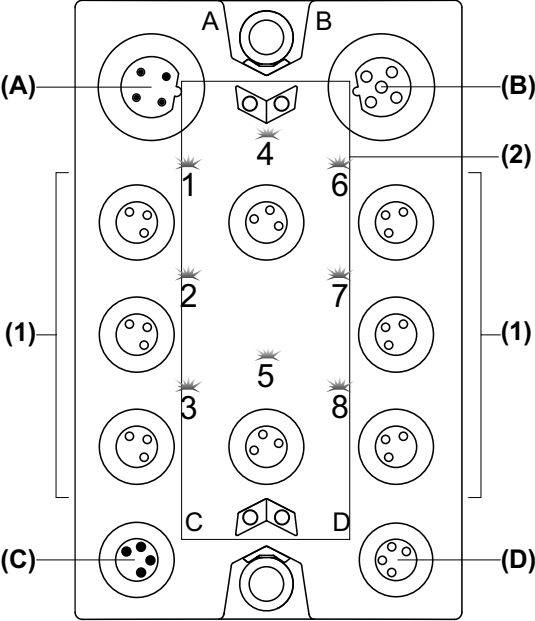

- (A) TM7 bus IN connector
- (B) TM7 bus OUT connector
- (C) 24 Vdc power IN connector
- (D) 24 Vdc power OUT connector
- (1) Input connectors
- (2) Status LEDs

Connector and Channel Assignments

The table below provides the connector and channel assignments of the TM7BDI8B block:

Input connectors	Status LEDs	Channel type	Channels
1	1	Input	I0
2	2	Input	I1
3	3	Input	I2
4	4 </td <td>Input</td> <td>I3</td>	Input	I3
5	5	Input	I4
6	6	Input	I5
7	7	Input	I6
8	8	Input	I7

Status LEDs

The following figure shows the status LEDs of the TM7BDI8B block:

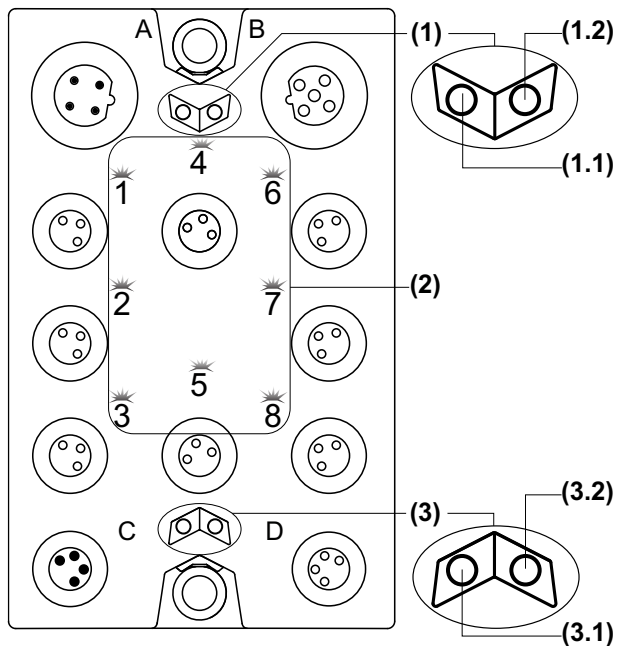

- 1 TM7 bus status LEDs, set of two LEDs: 1.1 (green) and 1.2 (red)
- 2 Channel LEDs, composed of eight LEDs: 1 to 8 (green)
- 3 Block status LEDs, set of two LEDs: 3.1 (green) to 3.2 (red)

The table below provides the TM7 bus status LEDs of the TM7BDI8B block:

TM7 bus status LEDs		Description
LED 1.1	LED 1.2	
OFF	OFF	No power supply on TM7 bus
ON	ON	TM7 bus in preoperational state: <ul style="list-style-type: none"> ● power supply on TM7 bus and ● block not initialized
ON	OFF	TM7 bus in operational state
OFF	ON	TM7 bus error detected

The table below provides the input status LEDs of the TM7BDI8B block:

Channel LEDs	State	Description
1 to 8	OFF	Corresponding input deactivated
1 to 8	ON	Corresponding input activated

The table below provides the input block status LEDs of the TM7BDI8B block:

Block status LEDs	State	Description
3.1	OFF	No power supply
	Single flash	Reset state
	Flashing	Preoperational state
	ON	Operational state
3.2	OFF	OK or no power supply
	ON	Detected error or reset state

TM7BDI8B Characteristics

General Characteristics

DANGER

POTENTIAL FOR EXPLOSION

- Only use this equipment in non-hazardous locations or in locations that comply either with the Class I, Division 2, Groups A, B, C and D, or with the ATEX Group II, Zone 2 specifications for hazardous locations, depending on your local and/or national regulations.
- Do not substitute components which would impair compliance to the hazardous location specifications of this equipment.
- Do not connect or disconnect equipment unless power has been removed or the location is known to be non-hazardous.

Failure to follow these instructions will result in death or serious injury.

NOTE: Additional equipment used in conjunction with the equipment described herein must also be suitable for the operating location.

DANGER

FIRE HAZARD

Use cable sizes that meet the I/O channel and power supply voltage and current ratings.

Failure to follow these instructions will result in death or serious injury.

WARNING

UNINTENDED EQUIPMENT OPERATION

Do not exceed any of the rated values specified in the environmental and electrical characteristics tables.

Failure to follow these instructions can result in death, serious injury, or equipment damage.

The table below provides the general characteristics of the TM7BDI8B block:

General characteristics	
Rated power supply voltage	24 Vdc
Power supply range	18...30 Vdc
24 Vdc I/O power segment current draw	42 mA

General characteristics	
TM7 power bus current draw	38 mA
Power dissipation	2.8 W max.
Weight	180 g (6.35 oz.)
ID code	5172 dec

See also Environmental Characteristics (*see page 23*).

Input Characteristics

The table below provides the input characteristics of the TM7BDI8B block:

Input characteristics		
Number of input channels	8	
Wiring type	2 or 3 wires	
Input range	18...30 Vdc	
Connection type	M8, female connector, 3-pin	
Rated input voltage	24 Vdc	
Input voltage range	18...30 Vdc	
Rated input current at 24 Vdc	7 mA	
Input signal type	Sink	
Input impedance	3.4 k Ω	
OFF state	U < 5 Vdc	
ON state	U > 15 Vdc I > 4.5 mA	
Input filter	Hardware	$\leq 100 \mu\text{s}$
	Software	1 ms
Isolation between channels	Not isolated	
Isolation between channels and bus	See note ¹	
Protection	Reverse polarity protection	

¹ The isolation of the block is 500 Vac RMS between the electronics powered by the TM7 power bus and those powered by the 24 Vdc I/O power segment connected to the block. In practice, there is a bridge between the TM7 power bus and the 24 Vdc I/O power segment. The two power circuits reference the same functional ground (FE) through specific components designed to reduce effects of electromagnetic interference. These components are rated at 30 Vdc or 60 Vdc. This effectively reduces isolation of the entire system from the 500 Vac RMS.

Sensor Supply

The table below provides the power supply for the sensors of the TM7BDI8B block:

Supply	
Voltage	24 Vdc I/O power segment supply less voltage drop for internal protection.
Voltage drop for internal protection at 500 mA	2 Vdc max.
Supply current (for all powered connected sensors)	500 mA max.
Internal protection	Overcurrent and short circuit

TM7BDI8B Wiring Diagram

Pin Assignments

The following figure shows the pin assignments for the input connectors of the TM7BDI8B block:

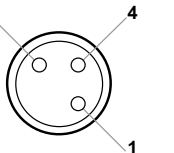
Connection	Pin	M8 Input
	1	24 Vdc sensor supply
	3	0 Vdc
	4	DI: input signal

⚠ DANGER

FIRE HAZARD

Use cable sizes that meet the I/O channel and power supply voltage and current ratings.

Failure to follow these instructions will result in death or serious injury.

If you do not properly wire the cable, you could introduce electromagnetic interference into the I/O block.

⚠ WARNING

ELECTROMAGNETIC INTERFERENCE

- Do not connect cables to connectors that are not properly wired to the sensor or actuator.
- Always use sealing plugs for any unused connectors.

Failure to follow these instructions can result in death, serious injury, or equipment damage.

⚠ WARNING

IP67 NON-CONFORMANCE

- Properly fit all connectors with cables or sealing plugs and tighten for IP67 conformance according to the torque values as specified in this document.
- Do not connect or disconnect cables or sealing plugs in the presence of water or moisture.

Failure to follow these instructions can result in death, serious injury, or equipment damage.

Chapter 4

TM7BDI16• Digital Input Blocks

What Is in This Chapter?

This chapter contains the following sections:

Section	Topic	Page
4.1	TM7BDI16B Block 16DI 24 Vdc Sink	54
4.2	TM7BDI16A Block 16DI 24 Vdc Sink	64

Section 4.1

TM7BDI16B Block 16DI 24 Vdc Sink

What Is in This Section?

This section contains the following topics:

Topic	Page
TM7BDI16B Presentation	55
TM7BDI16B Characteristics	60
TM7BDI16B Wiring Diagram	63

TM7BDI16B Presentation

Main Characteristics

The table below provides the main characteristics of the TM7BDI16B block:

Main characteristics	
Number of input channels	16
Input type	Type 1
Signal type	Sink
Rated input voltage	24 Vdc
Sensor connection type	M8, female connector type (<i>see page 63</i>)

Description

The following figure shows the TM7BDI16B block:

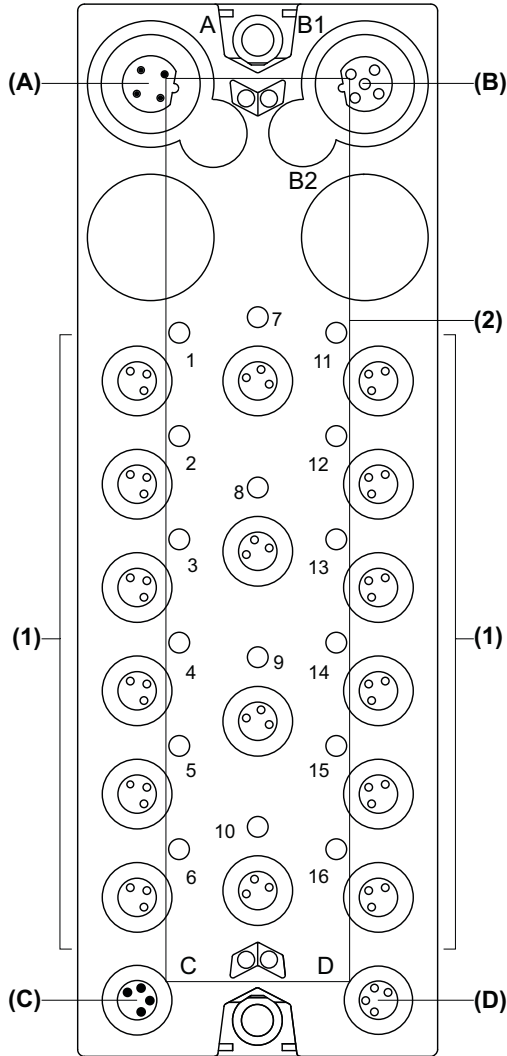

- (A) TM7 bus IN connector
- (B) TM7 bus OUT connector
- (C) 24 Vdc power IN connector
- (D) 24 Vdc power OUT connector
- (1) Input connectors
- (2) Status LEDs

Connector and Channel Assignments

The table below provides the connector and channel assignments of the TM7BDI16B block:

Input connectors	Status LEDs <i>(see page 58)</i>	Channel type	Channels
1	1	Input	I0
2	2	Input	I1
3	3	Input	I2
4	4	Input	I3
5	5	Input	I4
6	6	Input	I5
7	7	Input	I6
8	8	Input	I7
9	9	Input	I8
10	10	Input	I9
11	11	Input	I10
12	12	Input	I11
13	13	Input	I12
14	14	Input	I13
15	15	Input	I14
16	16	Input	I15

Status LEDs

The following figure shows the status LEDs of the TM7BDI16B block:

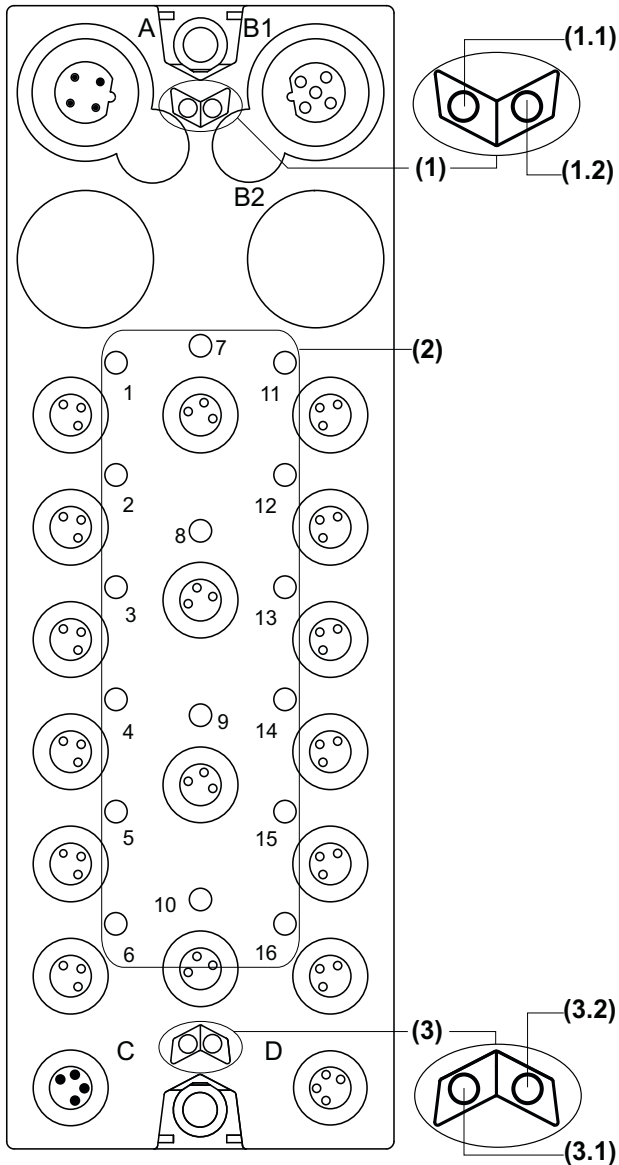

- 1 TM7 bus status LEDs, set of two LEDs: 1.1 (green) and 1.2 (red)
- 2 Channel LEDs, composed of sixteen LEDs (green)
- 3 Block status LEDs, set of two LEDs: 3.1 (green) and 3.2 (red)

The table below provides the TM7 bus status LEDs of the TM7BDI16B block:

TM7 bus status LEDs		Description
LED 1.1	LED 1.2	
OFF	OFF	No power supply on TM7 bus
ON	ON	TM7 bus in preoperational state: <ul style="list-style-type: none"> ● power supply on TM7 bus and ● block not initialized
ON	OFF	TM7 bus in operational state
OFF	ON	TM7 bus error detected

The table below provides the input status LEDs of the TM7BDI16B block:

Channel LEDs	State	Description
1 to 16	OFF	Corresponding input deactivated
1 to 16	ON	Corresponding input activated

The table below provides the input block status LEDs of the TM7BDI16B block:

Block status LEDs	State	Description
3.1	OFF	No power supply
	Single Flash	Reset state
	Flashing	Preoperational state
	ON	Operational state
3.2	OFF	OK or no power supply
	ON	Detected error or reset state

TM7BDI16B Characteristics

General Characteristics

DANGER

POTENTIAL FOR EXPLOSION

- Only use this equipment in non-hazardous locations or in locations that comply either with the Class I, Division 2, Groups A, B, C and D, or with the ATEX Group II, Zone 2 specifications for hazardous locations, depending on your local and/or national regulations.
- Do not substitute components which would impair compliance to the hazardous location specifications of this equipment.
- Do not connect or disconnect equipment unless power has been removed or the location is known to be non-hazardous.

Failure to follow these instructions will result in death or serious injury.

NOTE: Additional equipment used in conjunction with the equipment described herein must also be suitable for the operating location.

DANGER

FIRE HAZARD

Use cable sizes that meet the I/O channel and power supply voltage and current ratings.

Failure to follow these instructions will result in death or serious injury.

WARNING

UNINTENDED EQUIPMENT OPERATION

Do not exceed any of the rated values specified in the environmental and electrical characteristics tables.

Failure to follow these instructions can result in death, serious injury, or equipment damage.

The table below provides the general characteristics of the TM7BDI16B block:

General characteristics	
Rated power supply voltage	24 Vdc
Power supply range	18...30 Vdc
24 Vdc I/O power segment current draw	21 mA

General characteristics	
TM7 power bus current draw	38 mA
Power dissipation	2.3 W max.
Weight	320 g (11.28 oz.)
ID code	6682 dec

See also Environmental Characteristics (*see page 23*).

Input Characteristics

The table below provides the input characteristics of the TM7BDI16B block:

Input characteristics		
Number of input channels	16	
Wiring type	2 or 3 wires	
Input range	18...30 Vdc	
Connection type	M8, female connector, 3-pin	
Rated input voltage	24 Vdc	
Input voltage range	18...30 Vdc	
Rated input current at 24 Vdc	7 mA	
Input signals type	Sink	
Input impedance	3.4 kΩ	
OFF state	U < 5 Vdc	
ON state	U > 15 Vdc I > 4.5 mA	
Input filter	Hardware	≤100 μs
	Software	1 ms
Isolation between channels	Not isolated	
Isolation between channels and bus	See note ¹	
Protection	Reverse polarity protection	

¹ The isolation of the block is 500 Vac RMS between the electronics powered by the TM7 power bus and those powered by the 24 Vdc I/O power segment connected to the block. In practice, there is a bridge between the TM7 power bus and the 24 Vdc I/O power segment. The two power circuits reference the same functional ground (FE) through specific components designed to reduce effects of electromagnetic interference. These components are rated at 30 Vdc or 60 Vdc. This effectively reduces isolation of the entire system from the 500 Vac RMS.

Sensor Supply

The table below provides the power supply for the sensors of the TM7BDI16B block:

Supply	
Voltage	24 Vdc I/O power segment supply less voltage drop for internal protection.
Voltage drop for internal protection at 500 mA	2 Vdc max.
Supply current (for all powered connected sensors)	500 mA max.
Internal protection	Overcurrent and short circuit

TM7BDI16B Wiring Diagram

Pin Assignments

The following figure shows the pin assignments for the input connectors of the TM7BDI16B block:

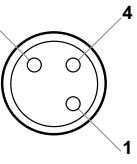
Connection	Pin	M8 Input
	1	24 Vdc sensor supply
	3	0 Vdc
	4	DI: input signal

⚠ DANGER

FIRE HAZARD

Use cable sizes that meet the I/O channel and power supply voltage and current ratings.

Failure to follow these instructions will result in death or serious injury.

If you do not properly wire the cable, you could introduce electromagnetic interference into the I/O block.

⚠ WARNING

ELECTROMAGNETIC INTERFERENCE

- Do not connect cables to connectors that are not properly wired to the sensor or actuator.
- Always use sealing plugs for any unused connectors.

Failure to follow these instructions can result in death, serious injury, or equipment damage.

⚠ WARNING

IP67 NON-CONFORMANCE

- Properly fit all connectors with cables or sealing plugs and tighten for IP67 conformance according to the torque values as specified in this document.
- Do not connect or disconnect cables or sealing plugs in the presence of water or moisture.

Failure to follow these instructions can result in death, serious injury, or equipment damage.

Section 4.2

TM7BDI16A Block 16DI 24 Vdc Sink

What Is in This Section?

This section contains the following topics:

Topic	Page
TM7BDI16A Presentation	65
TM7BDI16A Characteristics	70
TM7BDI16A Wiring Diagram	73

TM7BDI16A Presentation

Main Characteristics

The table below provides the main characteristics of the TM7BDI16A block:

Main characteristics	
Number of input channels	16
Input type	Type 1
Signal type	Sink
Rated input voltage	24 Vdc
Sensor connection type	M12, female connector type (<i>see page 73</i>)

Description

The following figure shows the TM7BDI16A block:

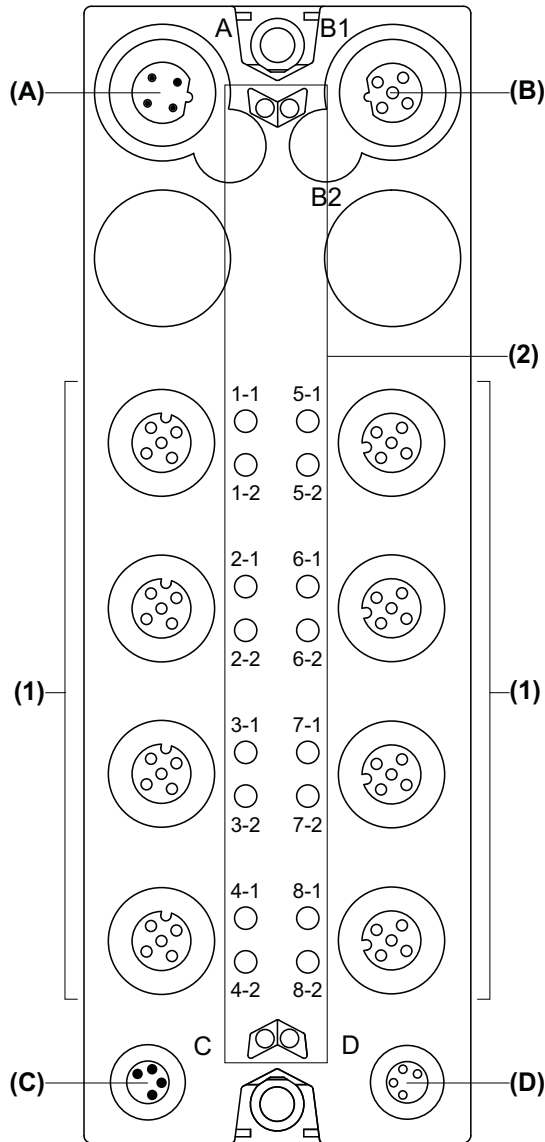

- (A) TM7 bus IN connector
- (B) TM7 bus OUT connector
- (C) 24 Vdc power IN connector
- (D) 24 Vdc power OUT connector

- (1) Input connectors
- (2) Status LEDs

Connector and Channel Assignments

The table below provides the connector and channel assignments of the TM7BDI16A block:

Input connectors	Status LEDs <i>(see page 68)</i>	Channel type	Channels
1	1-1	Input	I0
	1-2	Input	I1
2	2-1	Input	I2
	2-2	Input	I3
3	3-1	Input	I4
	3-2	Input	I5
4	4-1	Input	I6
	4-2	Input	I7
5	5-1	Input	I8
	5-2	Input	I9
6	6-1	Input	I10
	6-2	Input	I11
7	7-1	Input	I12
	7-2	Input	I13
8	8-1	Input	I14
	8-2	Input	I15

Status LEDs

The following figure shows the status LEDs of the TM7BDI16A block:

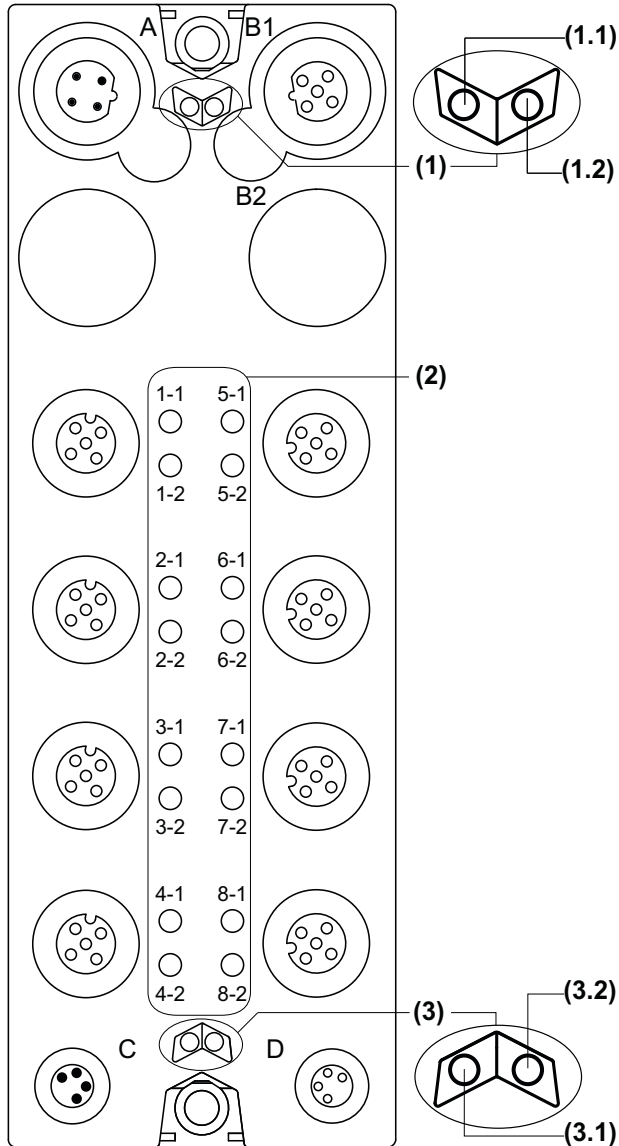

- 1 TM7 bus status LEDs, set of two LEDs: 1.1 (green) and 1.2 (red)
- 2 Channel LEDs, composed of eight sets of two LEDs: 1-1 to 8-2 (green)
- 3 Block status LEDs, set of two LEDs: 3.1 (green) and 3.2 (red)

The table below provides the TM7 bus status LEDs of the TM7BDI16A block:

TM7 bus status LEDs		Description
LED 1.1	LED 1.2	
OFF	OFF	No power supply on TM7 bus
ON	ON	TM7 bus in preoperational state: <ul style="list-style-type: none"> ● power supply on TM7 bus and ● block not initialized
ON	OFF	TM7 bus in operational state
OFF	ON	TM7 bus error detected

The table below provides the input status LEDs of the TM7BDI16A block:

Channel LEDs	State	Description
1-1 to 8-2	OFF	Corresponding input deactivated
1-1 to 8-2	ON	Corresponding input activated

The table below provides the input block status LEDs of the TM7BDI16A block:

Block status LEDs	State	Description
3.1	OFF	No power supply
	Single Flash	Reset state
	Flashing	Preoperational state
	ON	Operational state
3.2	OFF	OK or no power supply
	ON	Detected error or reset state

TM7BDI16A Characteristics

General Characteristics

DANGER

POTENTIAL FOR EXPLOSION

- Only use this equipment in non-hazardous locations or in locations that comply either with the Class I, Division 2, Groups A, B, C and D, or with the ATEX Group II, Zone 2 specifications for hazardous locations, depending on your local and/or national regulations.
- Do not substitute components which would impair compliance to the hazardous location specifications of this equipment.
- Do not connect or disconnect equipment unless power has been removed or the location is known to be non-hazardous.

Failure to follow these instructions will result in death or serious injury.

NOTE: Additional equipment used in conjunction with the equipment described herein must also be suitable for the operating location.

DANGER

FIRE HAZARD

Use cable sizes that meet the I/O channel and power supply voltage and current ratings.

Failure to follow these instructions will result in death or serious injury.

WARNING

UNINTENDED EQUIPMENT OPERATION

Do not exceed any of the rated values specified in the environmental and electrical characteristics tables.

Failure to follow these instructions can result in death, serious injury, or equipment damage.

The table below provides the general characteristics of the TM7BDI16A block:

General characteristics	
Rated power supply voltage	24 Vdc
Power supply range	18...30 Vdc
24 Vdc I/O power segment current draw	21 mA

General characteristics	
TM7 power bus current draw	38 mA
Power dissipation	2.3 W max.
Weight	320 g (11.28 oz.)
ID code	6683 dec

See also Environmental Characteristics (*see page 23*).

Input Characteristics

The table below provides the input characteristics of the TM7BDI16A block:

Input characteristics		
Number of input channels	16	
Wiring type	2 or 3 wires	
Input range	18...30 Vdc	
Connection type	M12, female connector, 5-pin	
Rated input voltage	24 Vdc	
Input voltage range	18...30 Vdc	
Rated input current at 24 Vdc	7 mA	
Input signals type	Sink	
Input impedance	3.4 k Ω	
OFF state	U < 5 Vdc	
ON state	U > 15 Vdc I > 4.5 mA	
Input filter	Hardware	$\leq 100 \mu\text{s}$
	Software	1 ms
Isolation between channels	Not isolated	
Isolation between channels and bus	See note ¹	
Protection	Reverse polarity protection	

¹ The isolation of the block is 500 Vac RMS between the electronics powered by the TM7 power bus and those powered by the 24 Vdc I/O power segment connected to the block. In practice, there is a bridge between the TM7 power bus and the 24 Vdc I/O power segment. The two power circuits reference the same functional ground (FE) through specific components designed to reduce effects of electromagnetic interference. These components are rated at 30 Vdc or 60 Vdc. This effectively reduces isolation of the entire system from the 500 Vac RMS.

Sensor Supply

The table below provides the power supply for the sensors of the TM7BDI16A block:

Supply	
Voltage	24 Vdc I/O power segment supply less voltage drop for internal protection.
Voltage drop for internal protection at 500 mA	2 Vdc max.
Supply current (for all powered connected sensors)	500 mA max.
Internal protection	Overcurrent and short circuit

TM7BDI16A Wiring Diagram

Pin Assignments

The following figure shows the pin assignments for the input connectors of the TM7BDI16A block:

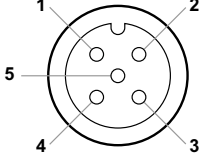
Connector	Pin	M12 Input
	1	24 Vdc sensor supply
	2	DI: input signal channel 1
	3	0 Vdc
	4	DI: input signal channel 2
	5	N.C.

DANGER

FIRE HAZARD

Use cable sizes that meet the I/O channel and power supply voltage and current ratings.

Failure to follow these instructions will result in death or serious injury.

If you do not properly wire the cable, you could introduce electromagnetic interference into the I/O block.

WARNING

ELECTROMAGNETIC INTERFERENCE

- Do not connect cables to connectors that are not properly wired to the sensor or actuator.
- Always use sealing plugs for any unused connectors.

Failure to follow these instructions can result in death, serious injury, or equipment damage.

WARNING

IP67 NON-CONFORMANCE

- Properly fit all connectors with cables or sealing plugs and tighten for IP67 conformance according to the torque values as specified in this document.
- Do not connect or disconnect cables or sealing plugs in the presence of water or moisture.

Failure to follow these instructions can result in death, serious injury, or equipment damage.

Part III

TM7 System Digital Output Blocks

Chapter 5

TM7BDO8TAB Digital Output Block

Section 5.1

TM7BDO8TAB Block 8DO 24 Vdc Source

What Is in This Section?

This section contains the following topics:

Topic	Page
TM7BDO8TAB Presentation	79
TM7BDO8TAB Characteristics	82
TM7BDO8TAB Wiring Diagram	86

TM7BDO8TAB Presentation

Main Characteristics

The table below provides the main characteristics of the TM7BDO8TAB block:

Main characteristics	
Number of output channels	8
Output type	Transistor, 2 A max.
Signal type	Source
Rated output voltage	24 Vdc
Sensor connection type	M8, female connector type <i>(see page 86)</i>

Description

The following figure shows the TM7BDO8TAB block:

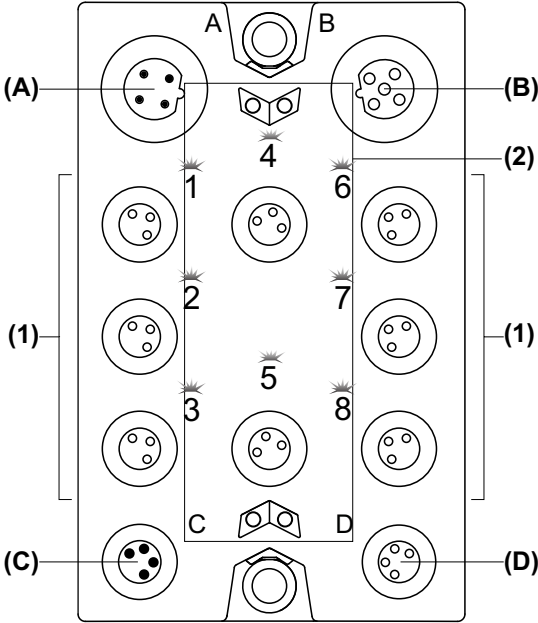

- (A) TM7 bus IN connector
- (B) TM7 bus OUT connector
- (C) 24 Vdc power IN connector
- (D) 24 Vdc power OUT connector
- (1) Output connectors
- (2) Status LEDs

Connector and Channel Assignments

The table below provides the connector and channel assignments of the TM7BDO8TAB block:

Output connectors	Status LEDs <i>(see page 80)</i>	Channel type	Channels
1	1	Output	Q0
2	2	Output	Q1
3	3	Output	Q2
4	4	Output	Q3
5	5	Output	Q4
6	6	Output	Q5
7	7	Output	Q6
8	8	Output	Q7

Status LEDs

The following figure shows the status LEDs of the TM7BDO8TAB block:

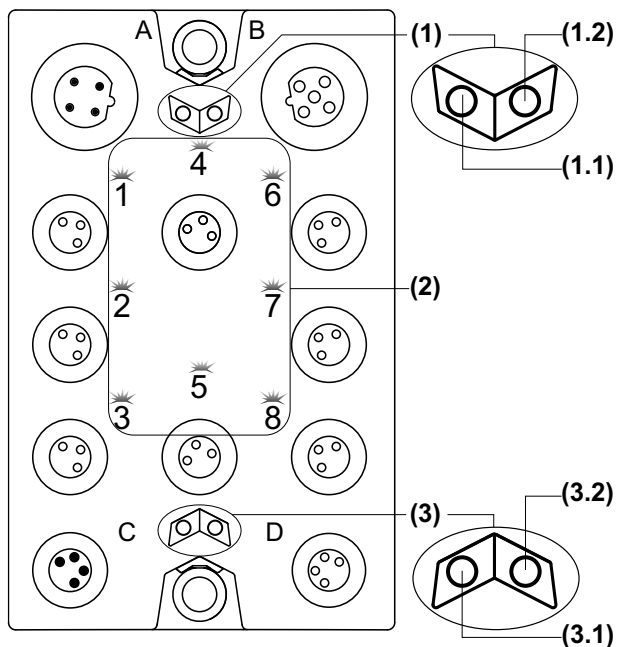

- 1 TM7 bus status LEDs, set of two LEDs: 1.1 (green) and 1.2 (red)
- 2 Channel LEDs, composed of eight LEDs (orange)
- 3 Block status LEDs, set of two LEDs: 3.1 (green) and 3.2 (red)

The table below provides the TM7 bus status LEDs of the TM7BDO8TAB block:

TM7 bus status LEDs		Description
LED 1.1	LED 1.2	
OFF	OFF	No power supply on TM7 bus
ON	ON	TM7 bus in preoperational state: <ul style="list-style-type: none"> ● power supply on TM7 bus and ● block not initialized
ON	OFF	TM7 bus in operational state
OFF	ON	TM7 bus error detected

The table below provides the output status LEDs of the TM7BDO8TAB block:

Channel LEDs	State	Description
1 to 8	OFF	Corresponding output deactivated
1 to 8	ON	Corresponding output activated

The table below provides the output block status LEDs of the TM7BDO8TAB block:

Block status LEDs	State	Description
3.1	OFF	No power supply
	Single Flash	Reset state
	Flashing	Preoperational state
	ON	Operational state
3.2	OFF	OK or no power supply
	ON	Detected error or reset state
	Single Flash	Detected error on an output channel

TM7BDO8TAB Characteristics

General Characteristics

DANGER

POTENTIAL FOR EXPLOSION

- Only use this equipment in non-hazardous locations or in locations that comply either with the Class I, Division 2, Groups A, B, C and D, or with the ATEX Group II, Zone 2 specifications for hazardous locations, depending on your local and/or national regulations.
- Do not substitute components which would impair compliance to the hazardous location specifications of this equipment.
- Do not connect or disconnect equipment unless power has been removed or the location is known to be non-hazardous.

Failure to follow these instructions will result in death or serious injury.

NOTE: Additional equipment used in conjunction with the equipment described herein must also be suitable for the operating location.

DANGER

FIRE HAZARD

Use cable sizes that meet the I/O channel and power supply voltage and current ratings.

Failure to follow these instructions will result in death or serious injury.

WARNING

UNINTENDED EQUIPMENT OPERATION

Do not exceed any of the rated values specified in the environmental and electrical characteristics tables.

Failure to follow these instructions can result in death, serious injury, or equipment damage.

The table below provides the general characteristics of the TM7BDO8TAB block:

General characteristics	
Rated power supply voltage	24 Vdc
Power supply range	18...30 Vdc
24 Vdc I/O power segment current draw	84 mA

General characteristics	
TM7 power bus current draw	34 mA
Power dissipation	3.8 W max.
Weight	185 g (6.52 oz.)
ID code	5223 dec

See also Environmental Characteristics (*see page 23*).

Output Characteristics

The table below provides the output characteristics of the TM7BDO8TAB block:

Output characteristics		
Number of output channels	8 (in 2 groups: Q0 to Q3 and Q4 to Q7)	
Wiring type	2 or 3 wires	
Connection type	M8, female connector, 3-pin	
Rated output voltage	24 Vdc	
Output voltage range	18...30 Vdc	
Output current	2 A max. per output	
Voltage drop	0.5 Vdc max. at 2 A rated current	
Total output current per group	4 A max.	
Total output current for the block	8 A max.	
Leakage current when switched off	5 μ A	
Output signal type	Source	
Turn on time	250 μ s max.	
Turn off time	270 μ s max.	
Switching frequency	Resistive load	100 Hz Max.
	Inductive load	See the switching inductive load characteristics (<i>see page 85</i>)
Breaking voltage when switching off inductive loads	Typically 50 Vdc	
Short circuit peak current	21 A max.	
Isolation between channels	Not isolated	
Isolation between channels and bus	See note ¹	
Protection	Reverse polarity protection	

Output characteristics	
Output protection	Against short-circuit and overcurrent, thermal protection
Automatic rearming after short circuit or overcurrent	Yes, 10 ms minimum depending on the internal temperature

¹ The isolation of the block is 500 Vac RMS between the electronics powered by the TM7 power bus and those powered by the 24 Vdc I/O power segment connected to the block. In practice, there is a bridge between the TM7 power bus and the 24 Vdc I/O power segment. The two power circuits reference the same functional ground (FE) through specific components designed to reduce effects of electromagnetic interference. These components are rated at 30 Vdc or 60 Vdc. This effectively reduces isolation of the entire system from the 500 Vac RMS.

Actuator Supply

The table below provides the power supply for the actuators of the TM7BDO8TAB block:

Supply	
Voltage	24 Vdc I/O power segment supply less voltage drop for internal protection.
Voltage drop for internal protection at 500 mA	2 Vdc max.
Supply current (for all powered connected actuators)	500 mA max.
Internal protection	Overcurrent and short circuit

Switching Inductive Load Characteristics

The following figure shows the switching inductive loads characteristics of the TM7BDO8TAB block:

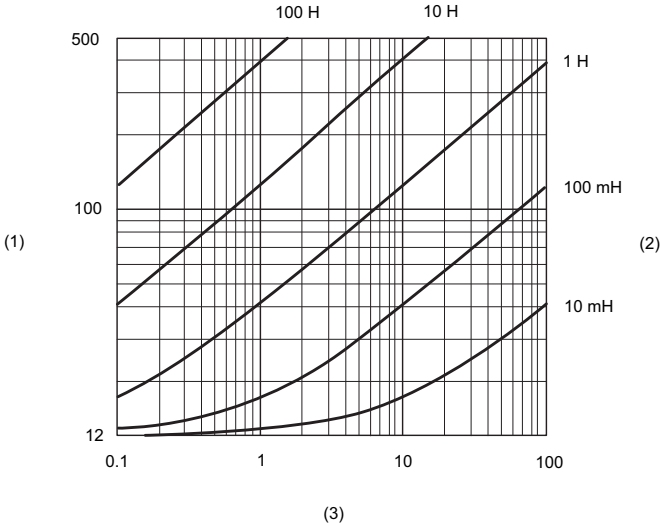

- (1) Load resistance in Ω
- (2) Load inductance in H
- (3) Max. operating cycles / second

TM7BDO8TAB Wiring Diagram

Pin Assignments

The following figure shows the pin assignments for the output connectors of the TM7BDO8TAB block:

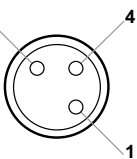
Connection	Pin	M8 Output
	1	24 Vdc actuator supply
	3	0 Vdc
	4	DO: output signal

⚠ DANGER

FIRE HAZARD

Use cable sizes that meet the I/O channel and power supply voltage and current ratings.

Failure to follow these instructions will result in death or serious injury.

If you do not properly wire the cable, you could introduce electromagnetic interference into the I/O block.

⚠ WARNING

ELECTROMAGNETIC INTERFERENCE

- Do not connect cables to connectors that are not properly wired to the sensor or actuator.
- Always use sealing plugs for any unused connectors.

Failure to follow these instructions can result in death, serious injury, or equipment damage.

⚠ WARNING

IP67 NON-CONFORMANCE

- Properly fit all connectors with cables or sealing plugs and tighten for IP67 conformance according to the torque values as specified in this document.
- Do not connect or disconnect cables or sealing plugs in the presence of water or moisture.

Failure to follow these instructions can result in death, serious injury, or equipment damage.

Wiring Diagram

The following figures show the wiring diagram for the output connectors of the TM7BDO8TAB block:

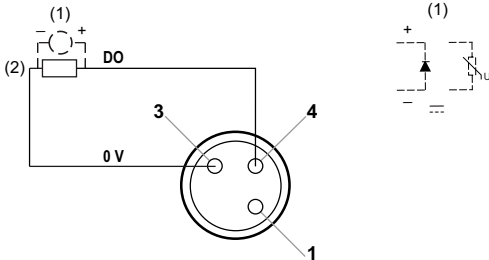

- (1) Inductive load protection
- (2) 2-wire load

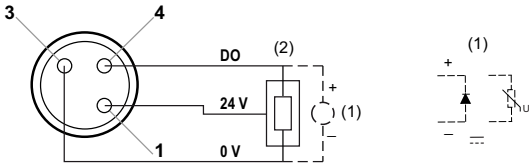

- (1) Inductive load protection
- (2) 3-wire load

NOTICE

INOPERABLE EQUIPMENT
Do not use an external power supply for actuators.
Failure to follow these instructions can result in equipment damage.

Part IV

TM7 System Digital Mixed Input/Output Blocks

What Is in This Part?

This part contains the following chapters:

Chapter	Chapter Name	Page
6	TM7BDM8•• Digital Mixed Blocks	91
7	TM7BDM16• Digital Mixed Blocks	101

Chapter 6

TM7BDM8•• Digital Mixed Blocks

Section 6.1

TM7BDM8B Block 8 Configurable DI/DO 24 Vdc

What Is in This Section?

This section contains the following topics:

Topic	Page
TM7BDM8B Presentation	93
TM7BDM8B Characteristics	96
TM7BDM8B Wiring Diagram	100

TM7BDM8B Presentation

Main Characteristics

The table below provides the main characteristics of the TM7BDM8B block:

Main characteristics	
Number of input/output channels	8
Input type	Type 1
Input signal type	Sink
Output type	Transistor, 0.5 A max.
Output signal type	Source
Sensor and actuator connection type	M8, female connector type <i>(see page 100)</i>

Description

The following figure shows the TM7BDM8B block:

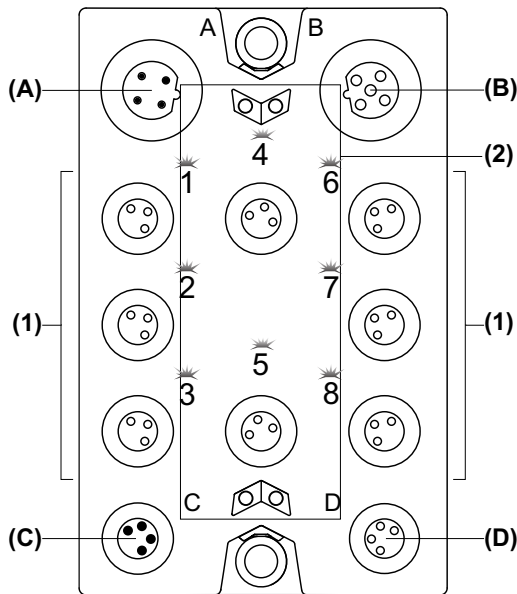

- (A) TM7 bus IN connector
- (B) TM7 bus OUT connector
- (C) 24 Vdc power IN connector
- (D) 24 Vdc power OUT connector
- (1) Input / Output connectors
- (2) Status LEDs

Connector and Channel Assignments

The table below provides the connector and channel assignments of the TM7BDM8B block. For further information, refer to I/O Configuration Tab:

I/O connectors	I/O status LEDs	Channel types	Channels
1	1	Input/Output	I0/Q0
2	2	Input/Output	I1/Q1
3	3	Input/Output	I2/Q2
4	4	Input/Output	I3/Q3
5	5	Input/Output	I4/Q4
6	6	Input/Output	I5/Q5
7	7	Input/Output	I6/Q6
8	8	Input/Output	I7/Q7

Status LEDs

The following figure shows the status LEDs of the TM7BDM8B block:

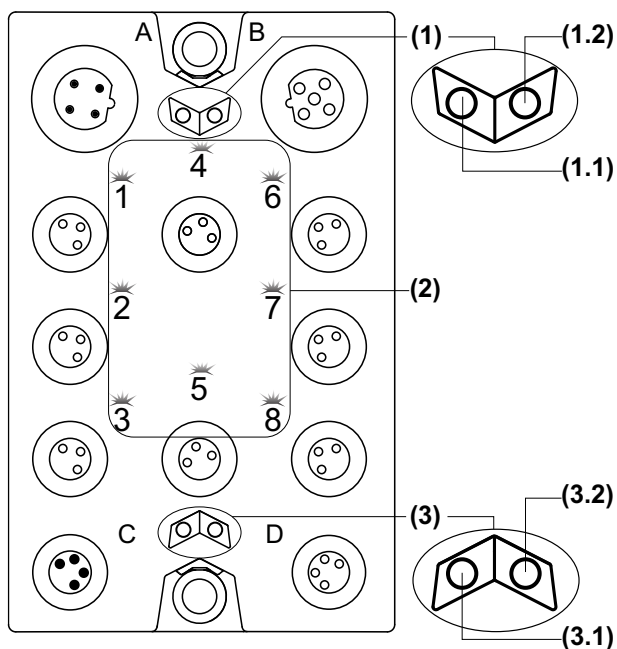

- 1 TM7 bus status LEDs, set of two LEDs: 1.1 (green) and 1.2 (red)
- 2 Channel LEDs, composed of eight LEDs: 1 to 8 (orange)
- 3 Block status LEDs, set of two LEDs: 3.1 (green) to 3.2 (red)

The table below provides the TM7 bus status LEDs of the TM7BDM8B block:

TM7 bus status LEDs		Description
LED 1.1	LED 1.2	
OFF	OFF	No power supply on TM7 bus
ON	ON	TM7 bus in preoperational state: <ul style="list-style-type: none"> ● power supply on TM7 bus and ● block not initialized
ON	OFF	TM7 bus in operational state
OFF	ON	TM7 bus error detected

The table below provides the I/O status LEDs of the TM7BDM8B block:

Channel LEDs	State	Description
1 to 8	OFF	Corresponding input/output deactivated
1 to 8	ON	Corresponding input/output activated

The table below provides the I/O block status LEDs of the TM7BDM8B block:

Block status LEDs	State	Description
3.1	OFF	No power supply
	Single Flash	Reset state
	Flashing	Preoperational state
	ON	Operational state
3.2	OFF	OK or no power supply
	Single Flash	Detected error for an I/O channel: DO: Overcurrent or short circuit
	Double Flash	Power supply not in the valid range
	ON	Detected error or reset state

TM7BDM8B Characteristics

General Characteristics

DANGER

POTENTIAL FOR EXPLOSION

- Only use this equipment in non-hazardous locations or in locations that comply either with the Class I, Division 2, Groups A, B, C and D, or with the ATEX Group II, Zone 2 specifications for hazardous locations, depending on your local and/or national regulations.
- Do not substitute components which would impair compliance to the hazardous location specifications of this equipment.
- Do not connect or disconnect equipment unless power has been removed or the location is known to be non-hazardous.

Failure to follow these instructions will result in death or serious injury.

NOTE: Additional equipment used in conjunction with the equipment described herein must also be suitable for the operating location.

DANGER

FIRE HAZARD

Use cable sizes that meet the I/O channel and power supply voltage and current ratings.

Failure to follow these instructions will result in death or serious injury.

WARNING

UNINTENDED EQUIPMENT OPERATION

Do not exceed any of the rated values specified in the environmental and electrical characteristics tables.

Failure to follow these instructions can result in death, serious injury, or equipment damage.

The table below provides the general characteristics of the TM7BDM8B block:

General characteristics	
Rated power supply voltage	24 Vdc
Power supply range	18...30 Vdc
24 Vdc I/O power segment current draw	105 mA

General characteristics	
TM7 power bus current draw	38 mA
Protection	Against reverse polarity
Power dissipation	4.3 W max.
Weight	190 g (6.7 oz.)
ID code	4881 dec

See also Environmental Characteristics (*see page 23*).

Input Characteristics

The table below provides the input characteristics of the TM7BDM8B block:

Input characteristics		
Number of input channels	8	
Wiring type	2 or 3 wires	
Input range	18...30 Vdc	
Rated input current at 24 Vdc	4.4 mA	
Input type	Sink	
Input impedance	5 k Ω	
OFF state	U < 5 Vdc	
ON state	U > 15 Vdc I > 3.5 mA	
Input filter	Hardware - Channels I0 to I3	$\leq 10 \mu\text{s}$
	Hardware - Channels I4 to I7	$\leq 70 \mu\text{s}$
	Software	Can be configured between 0 and 25 ms
Isolation between channels	Not isolated	
Isolation between channels and bus	See note ¹	

¹ The isolation of the block is 500 Vac RMS between the electronics powered by the TM7 power bus and those powered by the 24 Vdc I/O power segment connected to the block. In practice, there is a bridge between the TM7 power bus and the 24 Vdc I/O power segment. The two power circuits reference the same functional ground (FE) through specific components designed to reduce effects of electromagnetic interference. These components are rated at 30 Vdc or 60 Vdc. This effectively reduces isolation of the entire system from the 500 Vac RMS.

Output Characteristics

The table below provides the output characteristics of the TM7BDM8B block:

Output characteristics		
Number of output channels		8
Wiring type		2 or 3 wires
Output type		Source
Output current		0.5 A max. per output
Total output current for the block		4 A max.
Output range		18...30 Vdc
Voltage drop		0.3 Vdc max. at 0.5 A rated current
Leakage current when switched off		5 μ A
Turn on time		400 μ s max.
Turn off time		400 μ s max.
Switching frequency	Resistive load	100 Hz max.
	Inductive load	See the switching inductive load characteristics (<i>see page 99</i>)
Breaking voltage when switching off inductive loads		Typically 50 Vdc
Short circuit peak current		12 A max.
Isolation between channels		Not isolated
Isolation between channels and bus		See note ¹
Protection		Reverse polarity protection
Output protection		Against short-circuit and overcurrent, thermal protection
Automatic rearming after short circuit or overcurrent		Yes, 10 ms minimum depending on the internal temperature

¹ The isolation of the block is 500 Vac RMS between the electronics powered by the TM7 power bus and those powered by the 24 Vdc I/O power segment connected to the block. In practice, there is a bridge between the TM7 power bus and the 24 Vdc I/O power segment. The two power circuits reference the same functional ground (FE) through specific components designed to reduce effects of electromagnetic interference. These components are rated at 30 Vdc or 60 Vdc. This effectively reduces isolation of the entire system from the 500 Vac RMS.

Sensor and Actuator Supply

The table below provides the power supply for the sensors and actuators of the TM7BDM8B block:

Supply	
Voltage	24 Vdc I/O power segment supply less voltage drop for internal protection
Voltage drop for internal protection at 500 mA	2 Vdc max.
Supply current (for all powered connected sensors and actuators)	500 mA max.
Internal protection	Overcurrent and short circuit

Switching Inductive Load Characteristics

The curve provides the switching inductive load characteristics of the TM7BDM8B block:

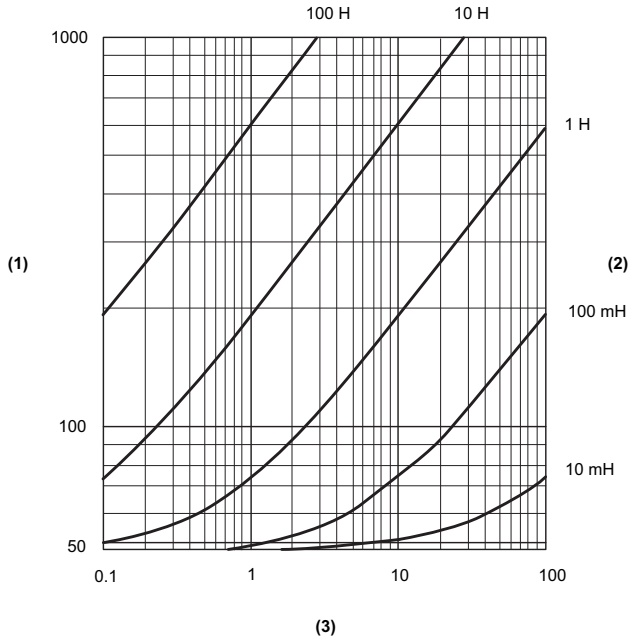

- (1) Load resistance in Ω
- (2) Load inductance in H
- (3) Max. operating cycles / second

TM7BDM8B Wiring Diagram

Pin Assignments

The following figure shows the pin assignments for the I/O connectors of the TM7BDM8B block:

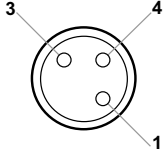
Connection	Pin	M8 input / output
	1	24 Vdc sensor / actuator supply
	3	0 Vdc
	4	DI/DO: input/output signal

DANGER

FIRE HAZARD

Use cable sizes that meet the I/O channel and power supply voltage and current ratings.

Failure to follow these instructions will result in death or serious injury.

If you do not properly wire the cable, you could introduce electromagnetic interference into the I/O block.

WARNING

ELECTROMAGNETIC INTERFERENCE

- Do not connect cables to connectors that are not properly wired to the sensor or actuator.
- Always use sealing plugs for any unused connectors.

Failure to follow these instructions can result in death, serious injury, or equipment damage.

WARNING

IP67 NON-CONFORMANCE

- Properly fit all connectors with cables or sealing plugs and tighten for IP67 conformance according to the torque values as specified in this document.
- Do not connect or disconnect cables or sealing plugs in the presence of water or moisture.

Failure to follow these instructions can result in death, serious injury, or equipment damage.

Chapter 7

TM7BDM16• Digital Mixed Blocks

What Is in This Chapter?

This chapter contains the following sections:

Section	Topic	Page
7.1	TM7BDM16A Block 16 Configurable DI/DO 24 Vdc	102
7.2	TM7BDM16B Block 16 Configurable DI/DO 24 Vdc	113

Section 7.1

TM7BDM16A Block 16 Configurable DI/DO 24 Vdc

What Is in This Section?

This section contains the following topics:

Topic	Page
TM7BDM16A Presentation	103
TM7BDM16A Characteristics	108
TM7BDM16A Wiring Diagram	112

TM7BDM16A Presentation

Main Characteristics

The table below provides the main characteristics of the TM7BDM16A block:

Main characteristics	
Number of input/output channels	16
Input type	Type 1
Input signal type	Sink
Output type	Transistor, 0.5 A max.
Output signal type	Source
Sensor and actuator connection type	M8, female connector type <i>(see page 112)</i>

Description

The following figure shows the TM7BDM16A block:

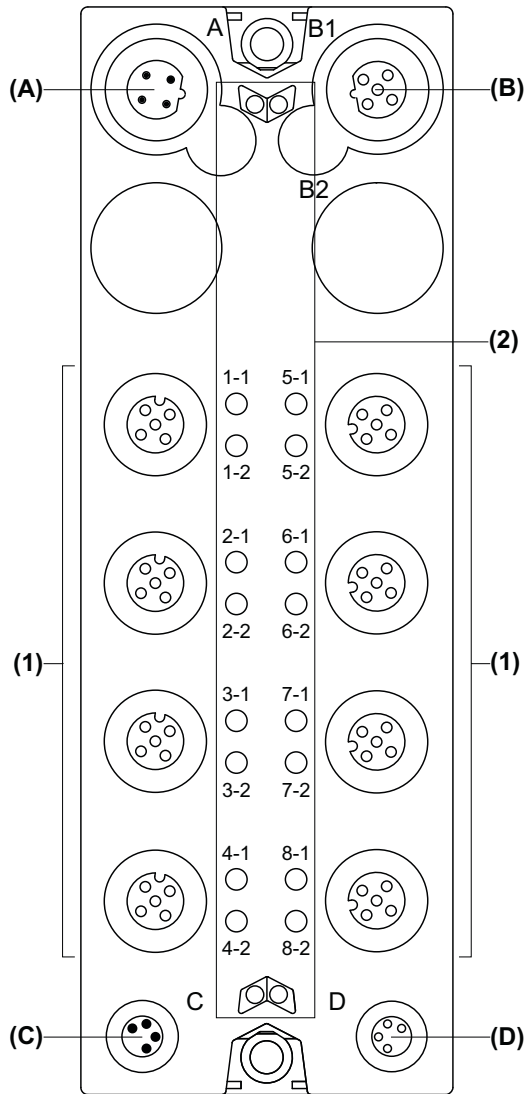

- (A) TM7 bus IN connector
- (B) TM7 bus OUT connector
- (C) 24 Vdc power IN connector
- (D) 24 Vdc power OUT connector
- (1) Input / Output connectors
- (2) Status LEDs

Connector and Channel Assignments

The table below provides the connector and channel assignments of the TM7BDM16A block. For further information, refer to I/O Configuration Tab:

I/O connectors	I/O status LEDs	Channel types	Channels
1	1-1	Input/Output	I0/Q0
	1-2	Input/Output	I1/Q1
2	2-1	Input/Output	I2/Q2
	2-2	Input/Output	I3/Q3
3	3-1	Input/Output	I4/Q4
	3-2	Input/Output	I5/Q5
4	4-1	Input/Output	I6/Q6
	4-2	Input/Output	I7/Q7
5	5-1	Input/Output	I8/Q8
	5-2	Input/Output	I9/Q9
6	6-1	Input/Output	I10/Q10
	6-2	Input/Output	I11/Q11
7	7-1	Input/Output	I12/Q12
	7-2	Input/Output	I13/Q13
8	8-1	Input/Output	I14/Q14
	8-2	Input/Output	I15/Q15

Status LEDs

The following figure shows the status LEDs of the TM7BDM16A block:

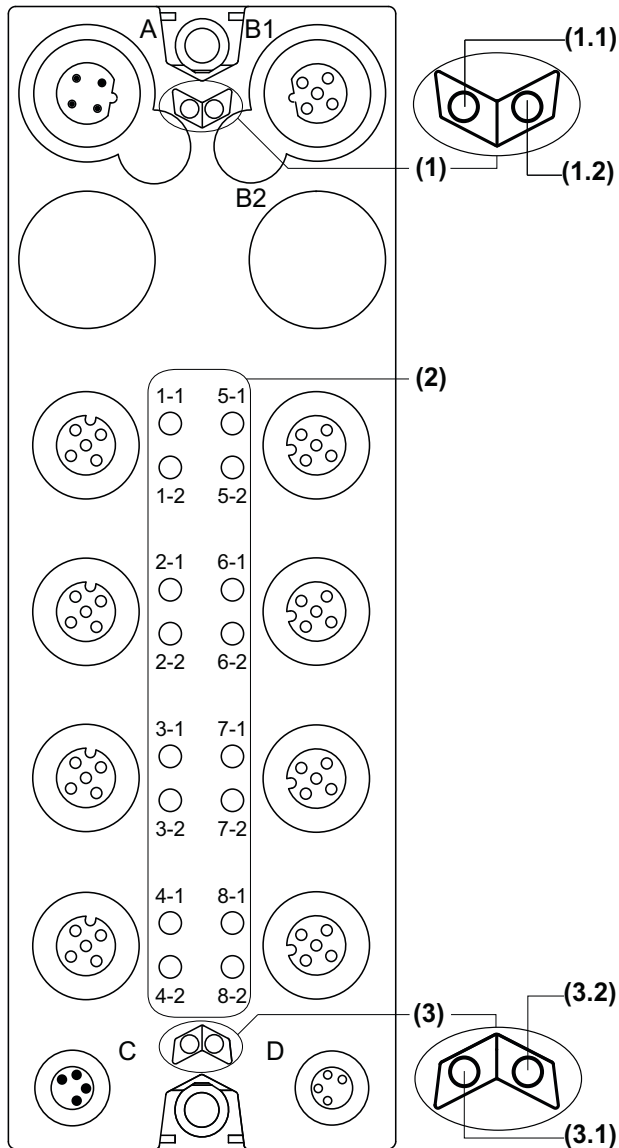

- 1 TM7 bus status LEDs, set of two LEDs: 1.1 (green) and 1.2 (red)
- 2 Channel LEDs, composed of eight sets of two LEDs: 1-1 to 8-2 (orange)
- 3 Block status LEDs, set of two LEDs: 3.1 (green) to 3.2 (red)

The table below provides the TM7 bus status LEDs of the TM7BDM16A block:

TM7 bus status LEDs		Description
LED 1.1	LED 1.2	
OFF	OFF	No power supply on TM7 bus
ON	ON	TM7 bus in preoperational state: <ul style="list-style-type: none"> ● power supply on TM7 bus and ● block not initialized
ON	OFF	TM7 bus in operational state
OFF	ON	TM7 bus error detected

The table below provides the I/O status LEDs of the TM7BDM16A block:

Channel LEDs	State	Description
1-1 to 8-2	OFF	Corresponding input/output deactivated
1-1 to 8-2	ON	Corresponding input/output activated

The table below provides the I/O block status LEDs of the TM7BDM16A block:

Block status LEDs	State	Description
3.1	OFF	No power supply
	Single Flash	Reset state
	Flashing	Preoperational state
	ON	Operational state
3.2	OFF	OK or no power supply
	Single Flash	Detected error for an I/O channel: <ul style="list-style-type: none"> ● DI: Overflow or underflow of the input signal ● DO: Overcurrent or short circuit
	Double Flash	Power supply not in the valid range
	ON	Detected error or reset state

TM7BDM16A Characteristics

General Characteristics

DANGER

POTENTIAL FOR EXPLOSION

- Only use this equipment in non-hazardous locations or in locations that comply either with the Class I, Division 2, Groups A, B, C and D, or with the ATEX Group II, Zone 2 specifications for hazardous locations, depending on your local and/or national regulations.
- Do not substitute components which would impair compliance to the hazardous location specifications of this equipment.
- Do not connect or disconnect equipment unless power has been removed or the location is known to be non-hazardous.

Failure to follow these instructions will result in death or serious injury.

NOTE: Additional equipment used in conjunction with the equipment described herein must also be suitable for the operating location.

DANGER

FIRE HAZARD

Use cable sizes that meet the I/O channel and power supply voltage and current ratings.

Failure to follow these instructions will result in death or serious injury.

WARNING

UNINTENDED EQUIPMENT OPERATION

Do not exceed any of the rated values specified in the environmental and electrical characteristics tables.

Failure to follow these instructions can result in death, serious injury, or equipment damage.

The table below provides the general characteristics of the TM7BDM16A block:

General characteristics	
Rated power supply voltage	24 Vdc
Power supply range	18...30 Vdc
24 Vdc I/O power segment current draw	125 mA

General characteristics	
TM7 power bus current draw	38 mA
Protection	Against reverse polarity
Power dissipation	4.8 W max.
Weight	320 g (11.28 oz.)
Id code	6685 dec

See also Environmental Characteristics (*see page 23*).

Input Characteristics

The table below provides the input characteristics of the TM7BDM16A block:

Input characteristics		
Number of input channels	16	
Wiring type	2 or 3 wires	
Input range	18...30 Vdc	
Rated input current at 24 Vdc	4.4 mA	
Input type	Sink	
Input impedance	5 k Ω	
OFF state	U < 5 Vdc	
ON state	U > 15 Vdc I > 3.5 mA	
Input filter	Hardware - Channels I0 to I3	$\leq 10 \mu\text{s}$
	Hardware - Channels I4 to I15	$\leq 70 \mu\text{s}$
	Software	Can be configured between 0 and 25 ms
Isolation between channels	Not isolated	
Isolation between channels and bus	See note ¹	

¹ The isolation of the block is 500 Vac RMS between the electronics powered by the TM7 power bus and those powered by the 24 Vdc I/O power segment connected to the block. In practice, there is a bridge between the TM7 power bus and the 24 Vdc I/O power segment. The two power circuits reference the same functional ground (FE) through specific components designed to reduce effects of electromagnetic interference. These components are rated at 30 Vdc or 60 Vdc. This effectively reduces isolation of the entire system from the 500 Vac RMS.

Output Characteristics

The table below provides the output characteristics of the TM7BDM16A block:

Output characteristics		
Number of output channels		16
Wiring type		2 or 3 wires
Output type		Source
Output current		0.5 A max. per output
Total output current for the block		8 A max.
Output range		18...30 Vdc
Voltage drop		0.3 Vdc max. at 0.5 A rated current
Leakage current when switched off		5 μ A
Turn on time		400 μ s max.
Turn off time		400 μ s max.
Switching frequency	Resistive load	100 Hz max.
	Inductive load	See the switching inductive load characteristics (<i>see page 111</i>)
Breaking voltage when switching off inductive loads		Typically 50 Vdc
Short circuit peak current		12 A max.
Isolation between channels		Not isolated
Isolation between channels and bus		See note ¹
Protection		Reverse polarity protection
Output protection		Against short-circuit and overcurrent, thermal protection
Automatic rearming after short circuit or overcurrent		Yes, 10 ms minimum depending on the internal temperature

¹ The isolation of the block is 500 Vac RMS between the electronics powered by the TM7 power bus and those powered by the 24 Vdc I/O power segment connected to the block. In practice, there is a bridge between the TM7 power bus and the 24 Vdc I/O power segment. The two power circuits reference the same functional ground (FE) through specific components designed to reduce effects of electromagnetic interference. These components are rated at 30 Vdc or 60 Vdc. This effectively reduces isolation of the entire system from the 500 Vac RMS.

Sensor and Actuator Supply

The table below provides the power supply for the sensors and actuators of the TM7BDM16A block:

Supply	
Voltage	24 Vdc I/O power segment supply less voltage drop for internal protection
Voltage drop for internal protection at 500 mA	2 Vdc max.
Supply current (for all powered connected sensors and actuators)	500 mA max.
Internal protection	Overcurrent and short circuit

Switching Inductive Load Characteristics

The following figure shows the switching inductive loads characteristics of the TM7BDM16A block:

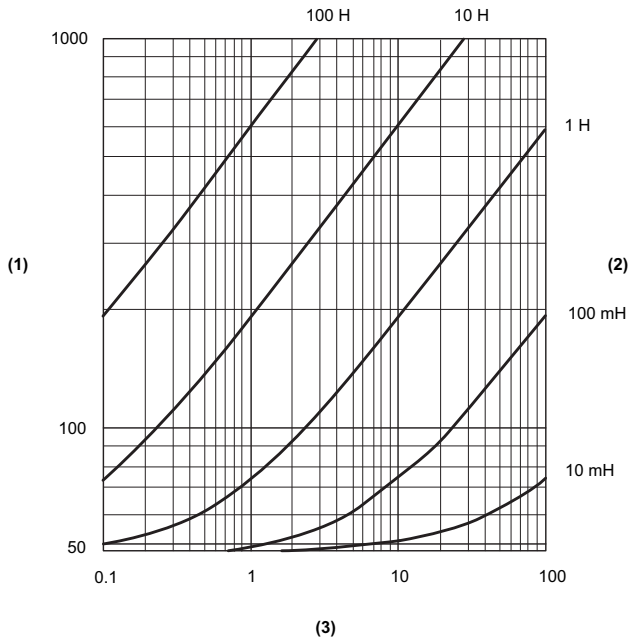

- (1) Load resistance in Ω
- (2) Load inductance in H
- (3) Max. operating cycles / second

TM7BDM16A Wiring Diagram

Pin Assignments

The following figure shows the pin assignments for the I/O connectors of the TM7BDM16A block:

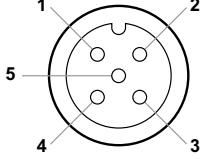
Connection	Pin	M12 input / output
	1	24 Vdc sensor / actuator supply
	2	DI/DO: input/output signal channel 1
	3	0 Vdc
	4	DI/DO: input/output signal channel 2
	5	N.C.

DANGER

FIRE HAZARD

Use cable sizes that meet the I/O channel and power supply voltage and current ratings.

Failure to follow these instructions will result in death or serious injury.

If you do not properly wire the cable, you could introduce electromagnetic interference into the I/O block.

WARNING

ELECTROMAGNETIC INTERFERENCE

- Do not connect cables to connectors that are not properly wired to the sensor or actuator.
- Always use sealing plugs for any unused connectors.

Failure to follow these instructions can result in death, serious injury, or equipment damage.

WARNING

IP67 NON-CONFORMANCE

- Properly fit all connectors with cables or sealing plugs and tighten for IP67 conformance according to the torque values as specified in this document.
- Do not connect or disconnect cables or sealing plugs in the presence of water or moisture.

Failure to follow these instructions can result in death, serious injury, or equipment damage.

Section 7.2

TM7BDM16B Block 16 Configurable DI/DO 24 Vdc

What Is in This Section?

This section contains the following topics:

Topic	Page
TM7BDM16B Presentation	114
TM7BDM16B Characteristics	119
TM7BDM16B Wiring Diagram	123

TM7BDM16B Presentation

Main Characteristics

The table below provides the main characteristics of the TM7BDM16B block:

Main characteristics	
Number of input/output channels	16
Input type	Type 1
Input signal type	Sink
Output type	Transistor, 0.5 A max.
Output signal type	Source
Sensor and actuator connection type	M8, female connector type <i>(see page 123)</i>

Description

The following figure shows the TM7BDM16B block:

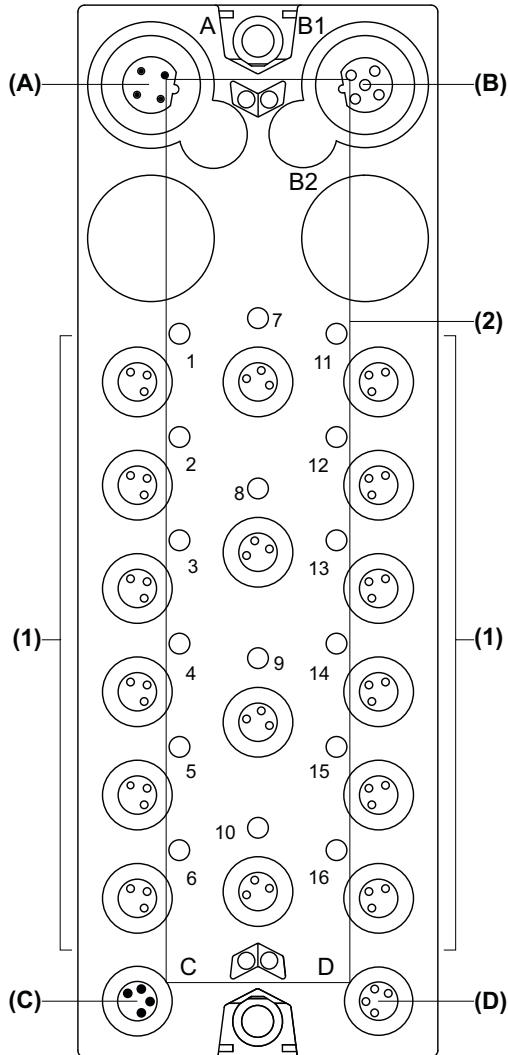

- (A) TM7 bus IN connector
- (B) TM7 bus OUT connector
- (C) 24 Vdc power IN connector
- (D) 24 Vdc power OUT connector
- (1) Input / Output connectors
- (2) Status LEDs

Connector and Channel Assignments

The table below provides the connector and channel assignments of the TM7BDM16B block. For further information, refer to I/O Configuration Tab:

I/O connectors	I/O status LEDs	Channel types	Channels
1	1	Input / Output	I0 / Q0
2	2	Input / Output	I1 / Q1
3	3	Input / Output	I2 / Q2
4	4	Input / Output	I3 / Q3
5	5	Input / Output	I4 / Q4
6	6	Input / Output	I5 / Q5
7	7	Input / Output	I6 / Q6
8	8	Input / Output	I7 / Q7
9	9	Input / Output	I8 / Q8
10	10	Input / Output	I9 / Q9
11	11	Input / Output	I10 / Q10
12	12	Input / Output	I11 / Q11
13	13	Input / Output	I12 / Q12
14	14	Input / Output	I13 / Q13
15	15	Input / Output	I14 / Q14
16	16	Input / Output	I15 / Q15

Status LEDs

The following figure shows the status LEDs of the TM7BDM16B block:

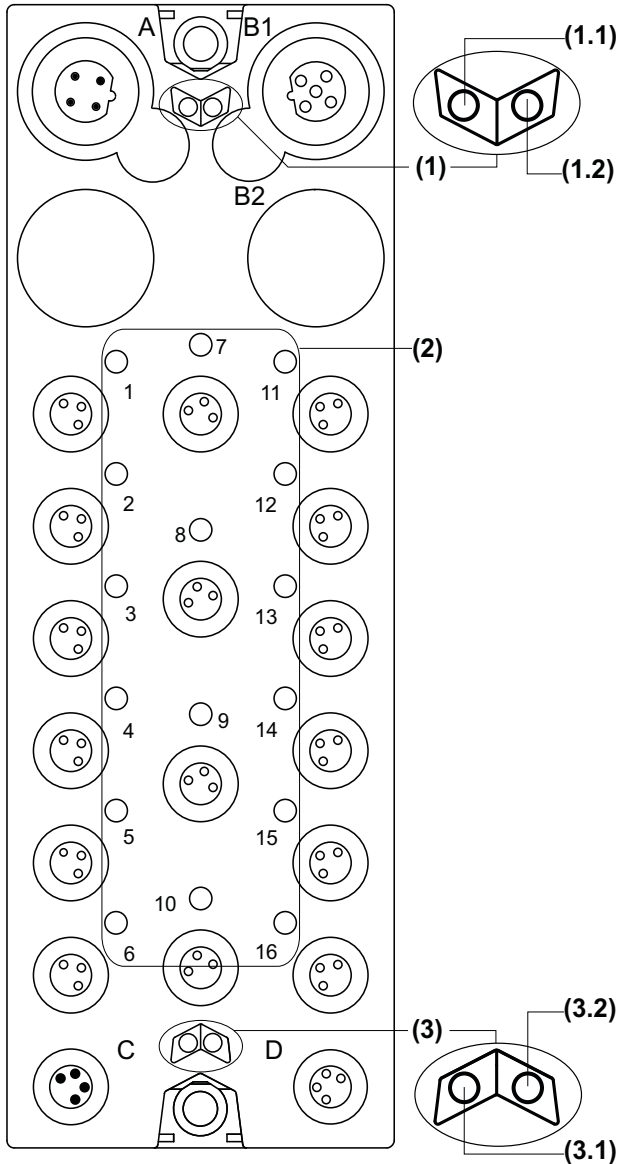

- (1) TM7 bus status LEDs, set of two LEDs: 1.1 (green) and 1.2 (red)
- (2) I/O status LEDs, composed of sixteen LEDs (orange)
- (3) I/O block status LEDs, set of two LEDs: 3.1 (green) and 3.2 (red)

The table below provides the TM7 bus status LEDs of the TM7BDM16B block:

TM7 bus status LEDs		Description
LED 1.1	LED 1.2	
OFF	OFF	No power supply on TM7 bus
ON	ON	TM7 bus in preoperational state: <ul style="list-style-type: none"> ● power supply on TM7 bus and ● block not initialized
ON	OFF	TM7 bus in operational state
OFF	ON	TM7 bus error detected

The table below provides the I/O status LEDs of the TM7BDM16B block:

Channel LEDs	State	Description
1 to 16	OFF	Corresponding input/output deactivated
1 to 16	ON	Corresponding input/output activated

The table below provides the I/O block status LEDs of the TM7BDM16B block:

Block status LEDs	State	Description
3.1	OFF	No power supply
	Single Flash	Reset state
	Flashing	Preoperational state
	ON	Operational state
3.2	OFF	OK or no power supply
	Single Flash	Detected error for an I/O channel: <ul style="list-style-type: none"> ● DI: Overflow or underflow of the input signal ● DO: Overcurrent or short circuit
	Double Flash	Power supply not in the valid range
	ON	Detected error or reset state

TM7BDM16B Characteristics

General Characteristics

⚠ DANGER

POTENTIAL FOR EXPLOSION

- Only use this equipment in non-hazardous locations or in locations that comply either with the Class I, Division 2, Groups A, B, C and D, or with the ATEX Group II, Zone 2 specifications for hazardous locations, depending on your local and/or national regulations.
- Do not substitute components which would impair compliance to the hazardous location specifications of this equipment.
- Do not connect or disconnect equipment unless power has been removed or the location is known to be non-hazardous.

Failure to follow these instructions will result in death or serious injury.

NOTE: Additional equipment used in conjunction with the equipment described herein must also be suitable for the operating location.

⚠ DANGER

FIRE HAZARD

Use cable sizes that meet the I/O channel and power supply voltage and current ratings.

Failure to follow these instructions will result in death or serious injury.

⚠ WARNING

UNINTENDED EQUIPMENT OPERATION

Do not exceed any of the rated values specified in the environmental and electrical characteristics tables.

Failure to follow these instructions can result in death, serious injury, or equipment damage.

The table below provides the general characteristics of the TM7BDM16B block:

General characteristics	
Rated power supply voltage	24 Vdc
Power supply range	18...30 Vdc
24 Vdc I/O segment current draw	125 mA
TM7 power bus current draw	38 mA

General characteristics	
Protection	Against reverse polarity
Power dissipation	4.8 W max.
Weight	320 g (11.28 oz.)
Id code	6684 dec

See also Environmental Characteristics (*see page 23*).

Input Characteristics

The table below provides the input characteristics of the TM7BDM16B block:

Input characteristics		
Number of input channels	16	
Wiring type	2 or 3 wires	
Input range	18...30 Vdc	
Rated input current at 24 Vdc	4.4 mA	
Input type	Sink	
Input impedance	5 k Ω	
OFF state	U < 5 Vdc	
ON state	U > 15 Vdc I > 3.5 mA	
Input filter	Hardware - Channels I0 to I3	$\leq 10 \mu\text{s}$
	Hardware - Channels I4 to I15	$\leq 70 \mu\text{s}$
	Software	Can be configured between 0 and 25 ms
Isolation between channels	Not isolated	
Isolation between channels and bus	See note ¹	

¹ The isolation of the block is 500 Vac RMS between the electronics powered by the TM7 power bus and those powered by the 24 Vdc I/O power segment connected to the block. In practice, there is a bridge between the TM7 power bus and the 24 Vdc I/O power segment. The two power circuits reference the same functional ground (FE) through specific components designed to reduce effects of electromagnetic interference. These components are rated at 30 Vdc or 60 Vdc. This effectively reduces isolation of the entire system from the 500 Vac RMS.

Output Characteristics

The table below provides the output characteristics of the TM7BDM16B block:

Output characteristics		
Number of output channels		16
Wiring type		2 or 3 wires
Output type		Source
Output current		0.5 A max. per output
Total output current for the block		8 A max.
Output range		18...30 Vdc
Voltage drop		0.3 Vdc max. at 0.5 A rated current
Leakage current when switched off		5 μ A
Turn on time		400 μ s max.
Turn off time		400 μ s max.
Switching frequency	Resistive load	100 Hz Max.
	Inductive load	See the switching inductive load characteristics (<i>see page 122</i>)
Breaking voltage when switching off inductive loads		Typically 50 Vdc
Short circuit peak current		21 A max.
Isolation between channels		Not isolated
Isolation between channels and bus		See note ¹
Protection		Reverse polarity protection
Output protection		Against short-circuit and overcurrent, thermal protection
Automatic rearming after short circuit or overcurrent		Yes, 10 ms minimum depending on the internal temperature

¹ The isolation of the block is 500 Vac RMS between the electronics powered by the TM7 power bus and those powered by the 24 Vdc I/O power segment connected to the block. In practice, there is a bridge between the TM7 power bus and the 24 Vdc I/O power segment. The two power circuits reference the same functional ground (FE) through specific components designed to reduce effects of electromagnetic interference. These components are rated at 30 Vdc or 60 Vdc. This effectively reduces isolation of the entire system from the 500 Vac RMS.

Sensor and Actuator Supply

The table below provides the power supply for the sensors and actuators of the TM7BDM16B block:

Supply	
Voltage	24 Vdc I/O power segment supply less voltage drop for internal protection
Voltage drop for internal protection at 500 mA	2 Vdc max.
Supply current (for all powered connected sensors and actuators)	500 mA max.
Internal protection	Overcurrent and short circuit

Switching Inductive Load Characteristics

The following figure shows the switching inductive loads characteristics of the TM7BDM16B block:

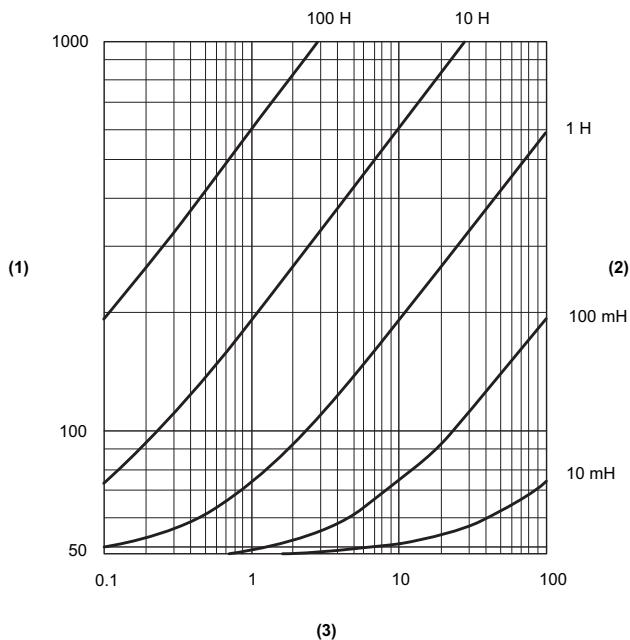

- (1) Load resistance in Ω
- (2) Load inductance in H
- (3) Max. operating cycles / second

TM7BDM16B Wiring Diagram

Pin Assignments

The following figure shows the pin assignments for the I/O connectors of the TM7BDM16B block:

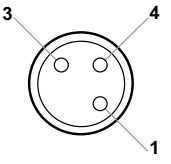
Connection	Pin	M8 input / output
	1	24 Vdc sensor / actuator supply
	3	0 Vdc
	4	DI/DO: input/output signal

DANGER

FIRE HAZARD

Use cable sizes that meet the I/O channel and power supply voltage and current ratings.

Failure to follow these instructions will result in death or serious injury.

If you do not properly wire the cable, you could introduce electromagnetic interference into the I/O block.

WARNING

ELECTROMAGNETIC INTERFERENCE

- Do not connect cables to connectors that are not properly wired to the sensor or actuator.
- Always use sealing plugs for any unused connectors.

Failure to follow these instructions can result in death, serious injury, or equipment damage.

WARNING

IP67 NON-CONFORMANCE

- Properly fit all connectors with cables or sealing plugs and tighten for IP67 conformance according to the torque values as specified in this document.
- Do not connect or disconnect cables or sealing plugs in the presence of water or moisture.

Failure to follow these instructions can result in death, serious injury, or equipment damage.



D

digital I/O

(digital input/output) An individual circuit connection at the electronic module that corresponds directly to a data table bit. The data table bit holds the value of the signal at the I/O circuit. It gives the control logic digital access to I/O values.

DIN

(Deutsches Institut für Normung) A German institution that sets engineering and dimensional standards.

E

EN

EN identifies one of many European standards maintained by CEN (*European Committee for Standardization*), CENELEC (*European Committee for Electrotechnical Standardization*), or ETSI (*European Telecommunications Standards Institute*).

I

IEC

(international electrotechnical commission) A non-profit and non-governmental international standards organization that prepares and publishes international standards for electrical, electronic, and related technologies.

input filter

A special function that helps reject extraneous signals on input lines due to such things as contact bounce and inducted electrical transients. Inputs provide a level of input filtering using the hardware. Additional filtering with software is also configurable through the programing or the configuration software.

IP 67

(ingress protection) The protection classification according to IEC 60529. IP 67 modules are protected against ingress of dust, contact, and water up to an immersion depth of 1 m.



B

- blocks overview
 - general description, *36*
 - physical description, *38*

C

- characteristics
 - environmental, *23*
 - TM7BDI16A, *70*
 - TM7BDI16B, *60*
 - TM7BDI8B, *48*
 - TM7BDM16A, *108*
 - TM7BDM16B, *119*
 - TM7BDM8B, *96*
 - TM7BDO8TAB, *82*

I

- installation
 - dimensions, *33*
 - requirements, *16*
- intended use, *6*

L

- labeling
 - TM7 block, *32*

P

- presentation
 - TM7BDI16A, *65*
 - TM7BDI16B, *55*
 - TM7BDI8B, *45*
 - TM7BDM16A, *103*
 - TM7BDM16B, *114*
 - TM7BDM8B, *93*
 - TM7BDO8TAB, *79*

Q

- qualification of personnel, *6*

T

- TM7, *35*
- TM7 analog, *35*
- TM7 digital, *35*
 - TM7BDI16A, *64*
 - TM7BDI16B, *54*
 - TM7BDI8B, *44*
 - TM7BDM16A, *102*
 - TM7BDM16B, *113*
 - TM7BDM8B, *92*
 - TM7BDO8TAB, *78*
- TM7 power distribution, *35*
- TM7BAI4CLA, *35*
- TM7BAI4PLA, *35*
- TM7BAI4TLA, *35*
- TM7BAI4VLA, *35*
- TM7BAM4CLA, *35*
- TM7BAM4VLA, *35*
- TM7BAO4CLA, *35*
- TM7BAO4VLA, *35*
- TM7BDI16A, *35, 64*
 - characteristics, *70*
 - presentation, *65*
 - wiring, *73*
- TM7BDI16B, *35, 54*
 - characteristics, *60*
 - presentation, *55*
 - wiring, *63*
- TM7BDI8B, *35, 44*
 - characteristics, *48*
 - presentation, *45*
 - wiring, *51*
- TM7BDM16A, *35, 102*
 - characteristics, *108*
 - presentation, *103*
 - wiring, *112*

- TM7BDM16B, *35, 113*
 - characteristics, *119*
 - presentation, *114*
 - wiring, *123*
- TM7BDM8B, *35, 92*
 - characteristics, *96*
 - presentation, *93*
 - wiring, *100*
- TM7BDO8TAB, *35, 78*
 - characteristics, *82*
 - presentation, *79*
 - wiring, *86*
- TM7SPS1A, *35*

W

wiring

- TM7BDI16A, *73*
- TM7BDI16B, *63*
- TM7BDI8B, *51*
- TM7BDM16A, *112*
- TM7BDM16B, *123*
- TM7BDM8B, *100*
- TM7BDO8TAB, *86*
- wiring rules, *19*