

Modicon TM5

Expansion Modules Configuration Programming Guide

11/2015

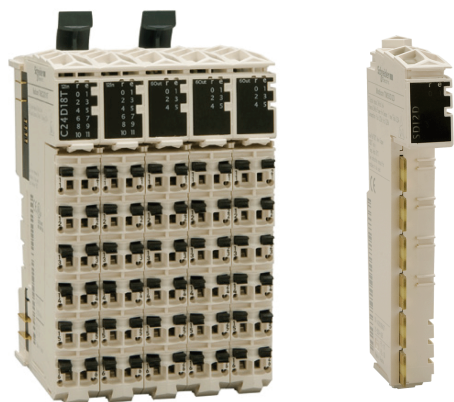

The information provided in this documentation contains general descriptions and/or technical characteristics of the performance of the products contained herein. This documentation is not intended as a substitute for and is not to be used for determining suitability or reliability of these products for specific user applications. It is the duty of any such user or integrator to perform the appropriate and complete risk analysis, evaluation and testing of the products with respect to the relevant specific application or use thereof. Neither Schneider Electric nor any of its affiliates or subsidiaries shall be responsible or liable for misuse of the information contained herein. If you have any suggestions for improvements or amendments or have found errors in this publication, please notify us.

No part of this document may be reproduced in any form or by any means, electronic or mechanical, including photocopying, without express written permission of Schneider Electric.

All pertinent state, regional, and local safety regulations must be observed when installing and using this product. For reasons of safety and to help ensure compliance with documented system data, only the manufacturer should perform repairs to components.

When devices are used for applications with technical safety requirements, the relevant instructions must be followed.

Failure to use Schneider Electric software or approved software with our hardware products may result in injury, harm, or improper operating results.

Failure to observe this information can result in injury or equipment damage.

© 2015 Schneider Electric. All rights reserved.

Table of Contents



	Safety Information	7
	About the Book	9
Chapter 1	I/O Configuration General Information	15
	TM5 Expansion Modules General Description	16
	TM5 Manager Configuration	23
	Adding an Expansion Module	26
Chapter 2	TM5 Compact I/O Modules	31
2.1	TM5 Compact I/O Modules	32
	TM5C24D18T	33
	TM5C12D8T	36
	TM5C12D6T6L	39
	TM5C24D12R	43
	TM5CAI8O8VL	46
	TM5CAI8O8CL	49
	TM5CAI8O8CVL	52
2.2	Integrated Electronic Modules	55
	Digital Input 4In	56
	Digital Input 6In	57
	Digital Input 12In	58
	Digital Output 4Out	59
	Digital Output 6Out	60
	Digital Output Relay 6Rel	61
	Analog Input 4AI ± 10 V	62
	Analog Input 4AI 0-20 mA / 4-20 mA	63
	Analog Input 4AI ± 10 V / 0-20 mA / 4-20 mA	64
	Analog Output 4AO ± 10 V	72
	Analog Output 4AO 0-20 mA	73
	Analog Output 2AO ± 10 V / 0-20 mA	74
Chapter 3	TM5 Digital I/O Electronic Modules	75
	TM5SDI2D, TM5SDI4D and TM5SDI6D	76
	TM5SDI2A, TM5SDI4A and TM5SDI6U	79
	TM5SDI12D	81
	TM5SDI16D	83
	TM5SDI2DF	85

	TM5SDO2T, TM5SDO4T, TM5SDO6T, TM5SDO12T, and TM5SDO16T	90
	TM5SDO4TA and TM5SDO8TA	93
	TM5SDO2R and TM5SDO4R	95
	TM5SDO2S	97
	TM5SDM12DT	99
	TM5SMM6D2L	101
Chapter 4	TM5 Analog I/O Electronic Modules	111
	TM5SAI2H and TM5SAI4H	112
	TM5SAI2L and TM5SAI4L	120
	TM5SAI2PH and TM5SAI4PH	129
	TM5SAI2TH and TM5SAI6TH	134
	TM5SAO2H and TM5SAO2L	141
	TM5SAO4H and TM5SAO4L	144
Chapter 5	TM5 Analog Strain Gauge Electronic Module	147
	TM5SEAISG	148
	Configuring a Strain Gauge Electronic Module	149
	Module Configuration	152
	Effective Resolution	153
Chapter 6	TM5 Expert I/O Electronic Modules	157
	TM5SE1IC02505	158
	TM5SE1IC01024	162
	TM5SE2IC01024	166
	TM5SE1SC10005	170
Chapter 7	TM5 Transmitter - Receiver Electronic Modules	173
	TM5SBET1	174
	TM5SBET7	176
	TM5SBER2	178
Chapter 8	TM5 Power Supply Electronic Modules	181
	TM5SPS1	182
	TM5SPS1F	184
	TM5SPS2	186
	TM5SPS2F	188

Chapter 9	TM5 Common Distribution Electronic Modules.	191
	TM5SPDG12F	192
	TM5SPDD12F	194
	TM5SPDG5D4F	196
	TM5SPDG6D6F	198
	TM5SD000	200
Glossary	201
Index	205

Safety Information



Important Information

NOTICE

Read these instructions carefully, and look at the equipment to become familiar with the device before trying to install, operate, service, or maintain it. The following special messages may appear throughout this documentation or on the equipment to warn of potential hazards or to call attention to information that clarifies or simplifies a procedure.



The addition of this symbol to a “Danger” or “Warning” safety label indicates that an electrical hazard exists which will result in personal injury if the instructions are not followed.



This is the safety alert symbol. It is used to alert you to potential personal injury hazards. Obey all safety messages that follow this symbol to avoid possible injury or death.

DANGER

DANGER indicates a hazardous situation which, if not avoided, **will result in** death or serious injury.

WARNING

WARNING indicates a hazardous situation which, if not avoided, **could result in** death or serious injury.

CAUTION

CAUTION indicates a hazardous situation which, if not avoided, **could result in** minor or moderate injury.

NOTICE

NOTICE is used to address practices not related to physical injury.

PLEASE NOTE

Electrical equipment should be installed, operated, serviced, and maintained only by qualified personnel. No responsibility is assumed by Schneider Electric for any consequences arising out of the use of this material.

A qualified person is one who has skills and knowledge related to the construction and operation of electrical equipment and its installation, and has received safety training to recognize and avoid the hazards involved.

About the Book



At a Glance

Document Scope

This manual describes the configuration of the Modicon TM5 Input/Output expansion modules. For further information, refer to the separate documents provided in the SoMachine online help.

Validity Note

This document has been updated for the release of SoMachine V4.1 SP2.

Related Documents

Title of Documentation	Reference Number
Modicon M258 Logic Controller Programming Guide	EIO0000000402 (Eng); EIO0000000403 (Fre); EIO0000000404 (Ger); EIO0000000405 (Spa); EIO0000000406 (Ita); EIO0000000407 (Chs)
Modicon LMC058 Motion Controller Programming Guide	EIO0000000408 (Eng); EIO0000000409 (Fre); EIO0000000410 (Ger); EIO0000000411 (Spa); EIO0000000412 (Ita); EIO0000000413 (Chs)
Modicon TM5 IoDrvTM5SEAI5G Strain Gauge Library Guide	EIO0000001185 (Eng), EIO0000001186 (Fre), EIO0000001187 (Ger), EIO0000001188 (Spa), EIO0000001189 (Ita), EIO0000001190 (Chs)
Modicon TM5 Compact I/O Modules Hardware Guide	EIO0000000456 (Eng); EIO0000000457 (Fre); EIO0000000458 (Ger); EIO0000000459 (Spa); EIO0000000460 (Ita); EIO0000000461 (Chs)

Title of Documentation	Reference Number
Modicon TM5 Digital I/O Modules Hardware Guide	EIO0000000444 (Eng); EIO0000000445 (Fre); EIO0000000446 (Ger); EIO0000000447 (Spa); EIO0000000448 (Ita); EIO0000000449 (Chs)
Modicon TM5 Analog I/O Modules Hardware Guide	EIO0000000450 (Eng); EIO0000000451 (Fre); EIO0000000452 (Ger); EIO0000000453 (Spa); EIO0000000454 (Ita); EIO0000000455 (Chs)
Modicon TM5 Expert (High Speed Counter) Modules Hardware Guide	EIO0000000462 (Eng); EIO0000000463 (Fre); EIO0000000464 (Ger); EIO0000000465 (Spa); EIO0000000466 (Ita); EIO0000000467 (Chs)
Modicon TM5 Transmitter and Receiver Modules Hardware Guide	EIO0000000468 (Eng); EIO0000000469 (Fre); EIO0000000470 (Ger); EIO0000000471 (Spa); EIO0000000472 (Ita); EIO0000000473 (Chs)

You can download these technical publications and other technical information from our website at <http://download.schneider-electric.com>

Product Related Information

WARNING

LOSS OF CONTROL

- The designer of any control scheme must consider the potential failure modes of control paths and, for certain critical control functions, provide a means to achieve a safe state during and after a path failure. Examples of critical control functions are emergency stop and overtravel stop, power outage and restart.
- Separate or redundant control paths must be provided for critical control functions.
- System control paths may include communication links. Consideration must be given to the implications of unanticipated transmission delays or failures of the link.
- Observe all accident prevention regulations and local safety guidelines.¹
- Each implementation of this equipment must be individually and thoroughly tested for proper operation before being placed into service.

Failure to follow these instructions can result in death, serious injury, or equipment damage.

¹ For additional information, refer to NEMA ICS 1.1 (latest edition), "Safety Guidelines for the Application, Installation, and Maintenance of Solid State Control" and to NEMA ICS 7.1 (latest edition), "Safety Standards for Construction and Guide for Selection, Installation and Operation of Adjustable-Speed Drive Systems" or their equivalent governing your particular location.

WARNING

UNINTENDED EQUIPMENT OPERATION

- Only use software approved by Schneider Electric for use with this equipment.
- Update your application program every time you change the physical hardware configuration.

Failure to follow these instructions can result in death, serious injury, or equipment damage.

Terminology Derived from Standards

The technical terms, terminology, symbols and the corresponding descriptions in this manual, or that appear in or on the products themselves, are generally derived from the terms or definitions of international standards.

In the area of functional safety systems, drives and general automation, this may include, but is not limited to, terms such as *safety*, *safety function*, *safe state*, *fault*, *fault reset*, *malfunction*, *failure*, *error*, *error message*, *dangerous*, etc.

Among others, these standards include:

Standard	Description
EN 61131-2:2007	Programmable controllers, part 2: Equipment requirements and tests.
ISO 13849-1:2008	Safety of machinery: Safety related parts of control systems. General principles for design.
EN 61496-1:2013	Safety of machinery: Electro-sensitive protective equipment. Part 1: General requirements and tests.
ISO 12100:2010	Safety of machinery - General principles for design - Risk assessment and risk reduction
EN 60204-1:2006	Safety of machinery - Electrical equipment of machines - Part 1: General requirements
EN 1088:2008 ISO 14119:2013	Safety of machinery - Interlocking devices associated with guards - Principles for design and selection
ISO 13850:2006	Safety of machinery - Emergency stop - Principles for design
EN/IEC 62061:2005	Safety of machinery - Functional safety of safety-related electrical, electronic, and electronic programmable control systems
IEC 61508-1:2010	Functional safety of electrical/electronic/programmable electronic safety-related systems: General requirements.
IEC 61508-2:2010	Functional safety of electrical/electronic/programmable electronic safety-related systems: Requirements for electrical/electronic/programmable electronic safety-related systems.
IEC 61508-3:2010	Functional safety of electrical/electronic/programmable electronic safety-related systems: Software requirements.
IEC 61784-3:2008	Digital data communication for measurement and control: Functional safety field buses.
2006/42/EC	Machinery Directive
2004/108/EC	Electromagnetic Compatibility Directive
2006/95/EC	Low Voltage Directive

In addition, terms used in the present document may tangentially be used as they are derived from other standards such as:

Standard	Description
IEC 60034 series	Rotating electrical machines
IEC 61800 series	Adjustable speed electrical power drive systems
IEC 61158 series	Digital data communications for measurement and control – Fieldbus for use in industrial control systems

Finally, the term *zone of operation* may be used in conjunction with the description of specific hazards, and is defined as it is for a *hazard zone* or *danger zone* in the *EC Machinery Directive (EC/2006/42)* and *ISO 12100:2010*.

NOTE: The aforementioned standards may or may not apply to the specific products cited in the present documentation. For more information concerning the individual standards applicable to the products described herein, see the characteristics tables for those product references.

Chapter 1

I/O Configuration General Information

Introduction

This chapter provides general considerations to configure I/O expansion modules.

What Is in This Chapter?

This chapter contains the following topics:

Topic	Page
TM5 Expansion Modules General Description	16
TM5 Manager Configuration	23
Adding an Expansion Module	26

TM5 Expansion Modules General Description

Introduction

The range of expansion I/O includes:

- TM5 Compact I/O modules with integrated electronic modules
- TM5 Digital I/O modules
- TM5 Analog I/O modules
- TM5 Expert I/O modules
- TM5 Transmitter - Receiver modules
- TM5 Power distribution modules
- TM5 Common distribution modules
- TM5 Dummy modules

Compact, digital or analog input modules convert measured values (voltages, currents) into numerical values which can be processed by the controller.

Compact, digital or analog output modules convert controller internal numerical values into voltages or currents.

Expert modules are used for counting. They use either a Synchronous Serial Interface (SSI) encoder, incremental encoder (ABR) or event counting.

The data transmitter and receiver modules handle the communication between remote module via expansion bus cables.

Power Distribution modules are used to manage the power supply for the various I/O modules.

The common distribution modules provide 0 Vdc and/or 24 Vdc terminal connections for the 24 Vdc I/O power segment(s) integrated into the bus bases, which expand the wiring possibilities for sensors and actuators.

The dummy module is a non-functional module. This module is used to separate modules which have specific thermal or EMC requirements, or as a place holder for later system expansion.

Compact I/O Expansion Features

Reference	Number of Channels	Voltage/Current
TM5C24D18T <i>(see page 33)</i>	24 digital inputs	24 Vdc / 3.75 mA
	18 digital outputs	24 Vdc / 0.5 A
TM5C12D8T <i>(see page 36)</i>	12 digital inputs	24 Vdc / 3.75 mA
	8 digital outputs	24 Vdc / 0.5 A
TM5C24D12R <i>(see page 43)</i>	24 inputs	24 Vdc / 3.75 mA
	12 relays NO contact	24 Vdc / 230 Vac 2 A
TM5CAI8O8VL <i>(see page 46)</i>	8 analog inputs	-10...+10 Vdc
	8 analog outputs	-10...+10 Vdc
TM5CAI8O8CL <i>(see page 49)</i>	8 analog inputs	0...20 mA / 4...20 mA
	8 analog outputs	0...20 mA
TM5CAI8O8CVL <i>(see page 52)</i>	4 analog inputs	-10...+10 Vdc
	4 analog inputs	0...20 mA / 4...20 mA
	4 analog outputs	-10...+10 Vdc
	4 analog outputs	0...20 mA
TM5C12D6T6L <i>(see page 39)</i>	12 digital inputs	24 Vdc / 3.75 mA
	6 digital outputs	24 Vdc / 0.5 A
	4 analog inputs	-10...+10 Vdc 0...20 mA/4...20 mA
	2 analog outputs	-10...+10 Vdc 0...20 mA

Digital I/O Expansion Features

Reference	Number of Channels	Voltage/Current
TM5SDI2D <i>(see page 76)</i>	2 inputs	24 Vdc / 3.75 mA
TM5SDI2DF <i>(see page 85)</i>	2 fast inputs	24 Vdc / 10.5 mA
TM5SDI4D <i>(see page 76)</i>	4 inputs	24 Vdc / 3.75 mA
TM5SDI6D <i>(see page 76)</i>	6 inputs	24 Vdc / 3.75 mA
TM5SDI12D <i>(see page 81)</i>	12 inputs	24 Vdc / 3.75 mA
TM5SDI16D <i>(see page 83)</i>	16 inputs	24 Vdc / 2.68 mA
TM5SDI2A <i>(see page 79)</i>	2 inputs	100...240 Vac
TM5SDI4A <i>(see page 79)</i>	4 inputs	100...240 Vac
TM5SDI6U <i>(see page 79)</i>	6 inputs	100...120 Vac
TM5SDO2T <i>(see page 90)</i>	2 outputs	24 Vdc / 0.5 A
TM5SDO4T <i>(see page 90)</i>	4 outputs	24 Vdc / 0.5 A
TM5SDO6T <i>(see page 90)</i>	6 outputs	24 Vdc / 0.5 A
TM5SDO12T <i>(see page 90)</i>	12 outputs	24 Vdc / 0.5 A
TM5SDO16T <i>(see page 90)</i>	16 outputs	24 Vdc / 0.5 A
TM5SDO4TA <i>(see page 93)</i>	4 outputs	24 Vdc / 2 A
TM5SDO8TA <i>(see page 93)</i>	8 outputs	24 Vdc / 2 A
TM5SDO2R <i>(see page 95)</i>	2 relays C/O contact	30 Vdc / 230 Vac 5 A
TM5SDO4R <i>(see page 95)</i>	4 relays NO contact	30 Vdc / 230 Vac 5 A
TM5SDO2S <i>(see page 97)</i>	2 outputs	230 Vac / 1 A

Reference	Number of Channels	Voltage/Current
TM5SDM12DT (see page 99)	8 inputs 4 outputs	24 Vdc / 7 mA 24 Vdc / 0.5 A
TM5SMM6D2L (see page 101)	4 digital inputs	24 Vdc / 3.3 mA
	2 digital outputs	24 Vdc / 0.5 A
	1 analog input	-10...+10 Vdc 0...20 mA / 4...20 mA
	1 analog output	-10...+10 Vdc 0...20 mA

Analog I/O Expansion Features

Reference	Number of Channels	Voltage/Current
TM5SAI2L (see page 120)	2 inputs	-10...+10 Vdc 0...20 mA / 4...20 mA
TM5SAI4L (see page 120)	4 inputs	-10...+10 Vdc 0...20 mA / 4...20 mA
TM5SAI2H (see page 112)	2 inputs	-10...+10 Vdc 0...20 mA
TM5SAI4H (see page 112)	4 inputs	-10...+10 Vdc 0...20 mA
TM5SAO2L (see page 141)	2 outputs	-10...+10 Vdc 0...20 mA
TM5SAO2H (see page 141)	2 outputs	-10...+10 Vdc 0...20 mA
TM5SAO4L (see page 144)	4 outputs	-10...+10 Vdc 0...20 mA
TM5SAO4H (see page 144)	4 outputs	-10...+10 Vdc 0...20 mA

Temperature Analog Expansion Features

Reference	Number of Channels	Sensor Type
TM5SAI2PH (see page 129)	2 inputs	PT100/1000
TM5SAI4PH (see page 129)	4 inputs	PT100/1000
TM5SAI2TH (see page 134)	2 inputs	Thermocouple J, K, N, S
TM5SAI6TH (see page 134)	6 inputs	Thermocouple J, K, N, S

Analog Strain Gauge Input Electronic Module Features

Reference	Number of Channels	Sensor Type
TM5SEAISG (see page 148)	1 input	Full-bridge strain gauge

Expert Expansion Features

Reference	Number of Channels	Encoder Inputs
TM5SE1IC02505 (see page 158)	1	5 Vdc Symmetrical
TM5SE1IC01024 (see page 162)	1	24 Vdc Asymmetrical
TM5SE2IC01024 (see page 166)	2	24 Vdc Asymmetrical
TM5SE1SC10005 (see page 170)	1	5 Vdc Symmetrical

Transmitter-Receiver Expansion Features

Reference	Modules Description
TM5SBET1 <i>(see page 174)</i>	TM5 data transmitter electronic module.
TM5SBET7 <i>(see page 176)</i>	TM5 data transmitter electronic module. It also distributes power to the TM7 bus.
TM5SBER2 <i>(see page 178)</i>	TM5 data receiver electronic module. It also distributes power to the TM5 bus and to the 24 Vdc I/O power segment.

Power Distribution Expansion Features

Reference	Modules Description
TM5SPS1 <i>(see page 182)</i>	24 Vdc I/O power segment supply
TM5SPS1F <i>(see page 184)</i>	24 Vdc I/O power segment supply with integrated fuse
TM5SPS2 <i>(see page 186)</i>	24 Vdc I/O power segment supply and TM5 bus supply
TM5SPS2F <i>(see page 188)</i>	24 Vdc I/O power segment supply with integrated fuse and TM5 bus supply

Common Distribution Expansion Features

Reference	Number of Channels	Voltage
TM5SPDG12F <i>(see page 192)</i>	12	24 Vdc
TM5SPDD12F <i>(see page 194)</i>	12	24 Vdc
TM5SPDG5D4F <i>(see page 196)</i>	2 x 5	0 Vdc - 24 Vdc
TM5SPDG6D6F <i>(see page 198)</i>	2 x 6	0 Vdc - 24 Vdc

Dummy Expansion Features

Reference	Number of Channels	Voltage
TM5SD000 (see page 200)	–	–

Match Software and Hardware Configuration

The I/O that may be embedded in your controller is independent of the I/O that you may have added in the form of I/O expansion. It is important that the logical I/O configuration within your program matches the physical I/O configuration of your installation. If you add or remove any physical I/O to or from the I/O expansion bus, update your application configuration (this is also true for any field bus devices you may have in your installation). Otherwise, there is the potential that the expansion bus or field bus will no longer function while the embedded I/O that may be present in your controller will continue to operate.

WARNING

UNINTENDED EQUIPMENT OPERATION

Update the configuration of your program each time you add or delete any type of I/O expansions on your I/O bus, or you add or delete any devices on your field bus.

Failure to follow these instructions can result in death, serious injury, or equipment damage.

To verify if the hardware and the software configuration match, use the **GVL TM5_Module_R** function regularly to monitor the expansion bus status.

Adding a TM5 Expansion Module

Refer to the TM5 Expansion Modules Configuration Programming Guide (see page 26).

TM5 Manager Configuration

TM5 Manager Configuration

To configure the TM5 Manager, proceed as follows:

Step	Action
1	In the Devices tree , expand the TM5 node.
2	Double-click the TM5_Manager node. Result: The TM5 Manager configuration window is displayed.
3	Select the I/O Configuration tab.

Parameters of the I/O Configuration:

Parameter	Value	Default Value	Unit	Description
Bus Cycle Time	0.5 ms 1 ms 2 ms 3 ms 4 ms 5 ms	1 ms	ms	Expansion Bus Cycle Time
Maximum number of physical slots	Number of Embedded modules...250	250	-	Maximum number of modules on the expansion bus.
Name of FW repository	Not configurable	-	-	This parameter indicates the Flash memory repository for the modules firmware.
Maximum bus length in meters (feet)	1...2500 (3.28...8202)	100 (328)	m	Total cable length used on the expansion bus.

NOTE: For more information about the maximum capacities of your system, refer to the TM5 / TM7 System Planning and Installation Guide (*see Modicon TM5 / TM7 Flexible System, System Planning and Installation Guide*).

Bus Cycle Time

Bus Cycle Time can be configured from 0.5 to 5 ms. Very fast cycles reduce the idle time for handling monitoring, diagnostics and acyclic commands.

The Bus Cycle Time follows 2 rules:

- Be longer than the greatest **Minimum Cycle Time** of any expansion module or block in the configuration.
- Be long enough to permit the data exchange with all the modules and the blocks.

Minimum Cycle Time

The Minimum Cycle Time of a module or of a block is the time needed by the module or the block to perform I/O management. If the Bus Cycle Time is shorter than this minimum value, the module will not operate properly.

Minimum I/O Update Time

The Minimum I/O Update Time of a module or block is the time needed by the module or block to update I/O on the bus. If the Bus Cycle Time is shorter than this minimum value, the I/O will be updated on the bus at the next Bus Cycle Time.

I/O Management

At the beginning of each task, the %I memory variable for the inputs used in the task is updated with the physical state of the input.

At the end of each task, the used %Q memory variable value for the outputs is updated.

On the next bus cycle after the end of the task configured as the **Bus cycle task**, the physical output is updated from the %Q memory variable value.





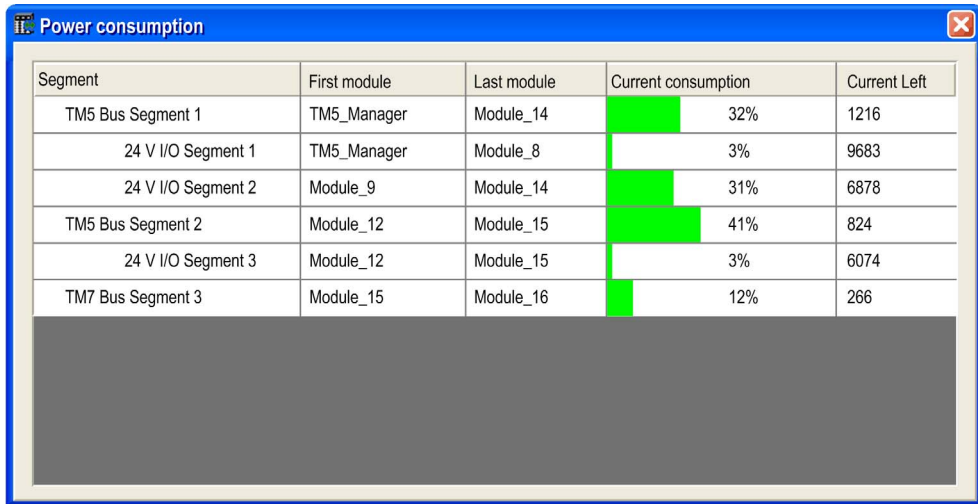

For more details on **Bus cycle task**, refer to the controller **PLC settings** tab.

Power Consumption

To display the estimated power consumption of the expansion modules:

Step	Action
1	Right-click the TM5_Manager node of the Device tree .
2	Select Power consumption .



Segment	First module	Last module	Current consumption	Current Left
TM5 Bus Segment 1	TM5_Manager	Module_14	 32%	1216
24 V I/O Segment 1	TM5_Manager	Module_8	 3%	9683
24 V I/O Segment 2	Module_9	Module_14	 31%	6878
TM5 Bus Segment 2	Module_12	Module_15	 41%	824
24 V I/O Segment 3	Module_12	Module_15	 3%	6074
TM7 Bus Segment 3	Module_15	Module_16	 12%	266

NOTE: The current consumption figures presented by the **Power consumption** function are based on assumed values, and not on actual current measurements. The assumed values for the outputs are based on classic loads but can be adjusted using the 24 Vdc I/O segment external current setting in the I/O Configuration (*see page 26*) tab of each module. The assumptions for input signals are based on known internal loads and are therefore not modifiable. While the use of the **Power consumption** function to test the power budget is required, it is no substitute for actual and complete system testing and commissioning. Refer to the TM5 / TM7 System Planning and Installation Guide (*see Modicon TM5 / TM7 Flexible System, System Planning and Installation Guide*).

Adding an Expansion Module

Procedure

To add an expansion module to your controller, select the expansion module in the **Hardware Catalog**, drag it to the **Devices tree**, and drop it on one of the highlighted nodes.

For more information on adding a device to your project, refer to:

- Using the Drag-and-drop Method (see *SoMachine, Programming Guide*)
- Using the Contextual Menu or Plus Button (see *SoMachine, Programming Guide*)

I/O Configuration

To configure TM5 expansion modules, double-click the expansion module you add in the **Devices tree**.

Result: The **I/O Configuration** window is displayed.

I/O Configuration Tab Description

Set the parameters of the expansion module using the **I/O Configuration** tab:















Parameter	Type	Value	Default Value	Unit	Description
Function Model	Enumeration of BYTE	default	default		
General					
Module address	USINT(0..250)	3	0		
Input filter	USINT(0..250)	10	10	0.1 ms	Specifies the filter time of a...
Bus base	Enumeration of BYTE	TM5ACBM11	TM5ACBM11		
Terminal block	Enumeration of BYTE	TM5ACTB06	TM5ACTB06		
24V I/O segment ex...	USINT(0..500)	100	100	mA	24V I/O segment external c...

The **I/O Configuration** tab contains these columns:



Column	Description	Editable
Parameter	Parameter name	No
Type	Parameter data type	No
Value	Value of the parameter	If the parameter is editable, an edit frame can be opened by double-clicking.
Default Value	Default parameter value	No
Unit	Unit value of the parameter	No
Description	Short description of the parameter	No

I/O Mapping Tab Description

Variables can be defined and named in the **I/O Mapping** tab. Additional information such as topological addressing is also provided in this tab:

I/O Mapping I/O Configuration Information								
Channels								
Variable	Mapping	Channel	Address	Type	Default Value	Unit	Description	
Inputs								
		DigitalInp...	%IB27	USINT				
		DigitalInp...	%IX2...	BOOL			24 VDC, 0.1 to 25 ms...	
		DigitalInp...	%IX2...	BOOL			24 VDC, 0.1 to 25 ms...	
		DigitalInp...	%IX2...	BOOL			24 VDC, 0.1 to 25 ms...	
		DigitalInp...	%IX2...	BOOL			24 VDC, 0.1 to 25 ms...	
		DigitalInp...	%IX2...	BOOL			24 VDC, 0.1 to 25 ms...	
		DigitalInp...	%IX2...	BOOL			24 VDC, 0.1 to 25 ms...	

The **I/O Mapping** tab contains these columns:

Column	Description
Variable	Lets you map the channel on a variable. Double-click the  icon to enter the variable name. If it is a new variable, the variable is created. It is also possible to map an existing variable with the variables Input Assistant by clicking the  button.
Mapping	Indicates if the channel is mapped on a new variable or an existing variable.
Channel	Name of the channel of the device.
Address	Address of the channel.
Type	Data type of the channel.
Current Value	Current value of the channel, displayed in online mode.
Default Value	Value taken by the output when the controller is in a STOPPED or HALT state. For more details, refer to Logic Controller PLC Settings (see <i>Modicon M258 Logic Controller, Programming Guide</i>) or Motion Controller PLC Settings (see <i>Modicon LMC058 Motion Controller, Programming Guide</i>). Double-click to change the default value.
Unit	Unit of the channel value.
Description	Description of the channel.

NOTE: %I value is updated from physical information at the beginning of each task using the %I. Physical output level is updated from memory variable for the outputs value within the task configured by **Bus cycle task** configuration.

For more details on **Bus cycle task**, refer to Logic Controller PLC Settings (see *Modicon M258 Logic Controller, Programming Guide*) or Motion Controller PLC Settings (see *Modicon LMC058 Motion Controller, Programming Guide*).

TM5 Bus Bases

Set the TM5 bus base in the **I/O Configuration** tab to be consistent with your hardware configuration.

NOTE: This does not apply to compact I/O modules.

This figure shows the TM5 bus bases:

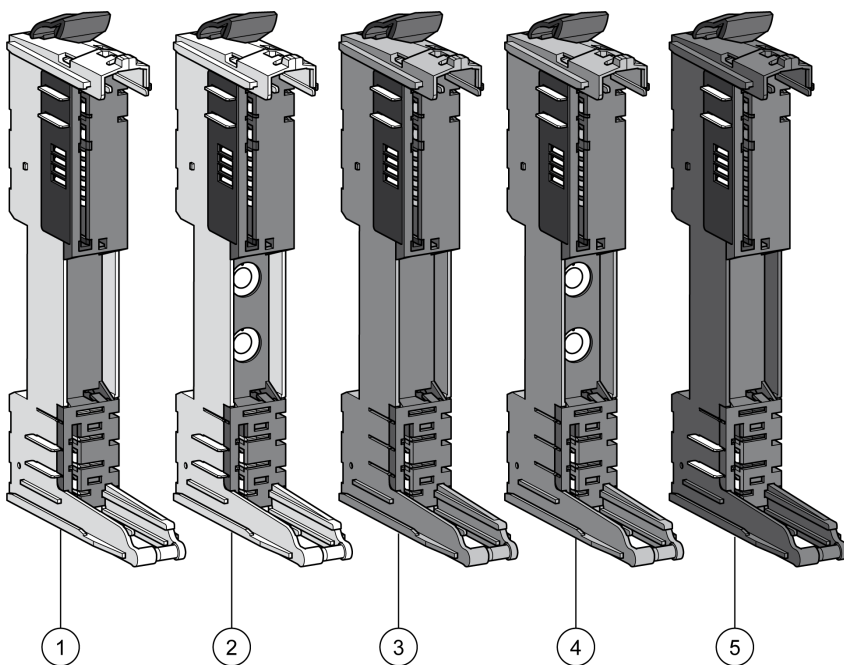

Number	Reference	Description	Color
1	TM5ACBM11	Bus base 24 Vdc 24 Vdc I/O power segment pass-through.	White
2	TM5ACBM15	Bus base 24 Vdc 24 Vdc I/O power segment pass-through with address setting ⁽¹⁾ .	White
3	TM5ACBM01R	Bus base 24 Vdc 24 Vdc I/O power segment left isolated.	Gray
4	TM5ACBM05R	Bus base 24 Vdc 24 Vdc I/O power segment left isolated with address setting ⁽¹⁾ .	Gray
5	TM5ACBM12	Bus base 240 Vac 24 Vdc I/O power segment pass-through isolated from the 240 Vac.	Black

⁽¹⁾ In certain cases, it is necessary to define specific slices or potential groups at a fixed address, regardless of the preceding modules in the backplane. For this purpose, there are bus bases in the TM5 System with address setting rotary switches, that allow you to set the address setting number of the slice. All subsequent slices refer to this offset and are addressed thereafter automatically.

Set the physical address of the TM5ACBM15 and TM5ACBM05R using the **Module address** parameter available from the **I/O Configuration** tab of the module. This parameter becomes editable only when the TM5ACBM15 and TM5ACBM05R are selected in the **Bus base** parameter. The value of the module address set in the **I/O Configuration** tab must be identical to the address set on your hardware.

For further information, refer to TM5 Addressing (*see Modicon TM5 / TM7 Flexible System, System Planning and Installation Guide*).

TM5 Terminal Blocks

Set the TM5 terminal block in the **I/O Configuration** tab to be consistent with your hardware configuration.

This figure shows the TM5 terminal blocks:

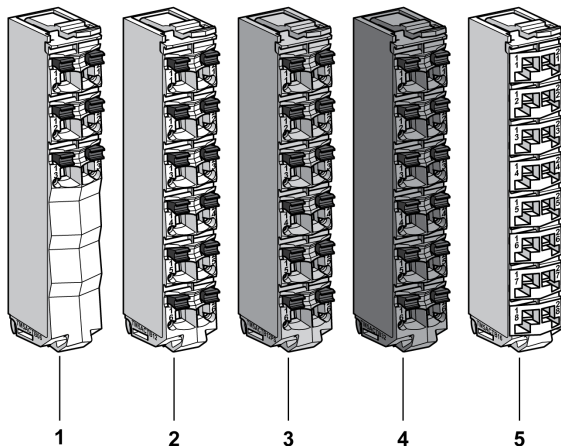

Number	Reference	Description	Color
1	TM5ACTB06	6-pin terminal block designed for 24 Vdc I/O modules.	White
2	TM5ACTB12	12-pin terminal block designed for 24 Vdc I/O modules.	White
3	TM5ACTB12PS	12-pin terminal block designed for 24 Vdc Power Distribution Modules (PDM), Interface Power Distribution Modules (IPDM), and receiver electronic module (TM5SBER2).	Gray
4	TM5ACTB32	12-pin terminal block designed for 240 Vac I/O modules.	Black
5	TM5ACTB16	16-pin terminal block designed for 24 Vdc I/O modules.	White

Chapter 2

TM5 Compact I/O Modules

Introduction

This chapter provides information to configure compact I/O and their integrated electronic modules:

- TM5C24D18T with the 12In and 6Out electronic modules,
- TM5C12D8T with the 4In and 4Out electronic modules,
- TM5C24D12R with the 12In and 6Rel electronic modules,
- TM5CAI8O8VL with the 4AI ± 10 V and 4AO ± 10 V electronic modules,
- TM5CAI8O8CL with the 4AI 0-20 mA / 4-20 mA and 4AO 0-20 mA electronic modules,
- TM5CAI8O8CVL with the 4AI ± 10 V, 4AI 0-20 mA / 4-20 mA, 4AO ± 10 V and 4AO 0-20 mA electronic modules,
- TM5C12D6T6L with the 6In, 6Out, 4AI ± 10 V / 0-20 mA / 4-20 mA and 2AO ± 10 V / 0-20 mA electronic modules.

To add the expansion electronic modules contained in the compact I/O modules, and to access the configuration screens, refer to Adding an expansion electronic module ([see page 26](#)).

What Is in This Chapter?

This chapter contains the following sections:

Section	Topic	Page
2.1	TM5 Compact I/O Modules	32
2.2	Integrated Electronic Modules	55

Section 2.1

TM5 Compact I/O Modules

Introduction

This section shows you how to configure the compact I/O modules.

What Is in This Section?

This section contains the following topics:

Topic	Page
TM5C24D18T	33
TM5C12D8T	36
TM5C12D6T6L	39
TM5C24D12R	43
TM5CAI8O8VL	46
TM5CAI8O8CL	49
TM5CAI8O8CVL	52

TM5C24D18T

Introduction

The TM5C24D18T compact I/O module is a set of 5 TM5 24 Vdc input and output electronic modules assembled together.

This set includes:

- 2 digital input electronic modules
- 3 digital output electronic modules

For further information, refer to the TM5C24D18T General Description (see *Modicon TM5, Compact I/O Modules, Hardware Guide*).

I/O Configuration Tab

To configure the TM5C24D18T compact I/O module, select the **I/O Configuration** tab.

This table describes the **General** parameters of the TM5C24D18T compact I/O module:

Parameter	Value	Default Value	Description
Module address	0...250	0	The address is automatically set when adding the compact I/O modules. The address value depends on the order of adding the module in the Devices tree . The compact I/O module does not support the possibility to change the address.

Set each of the I/O electronic modules individually using the **Pos.xx - SDEM** (SDEM = Short Description of the Electronic Module, like 12In, 6Out, 4AI ± 10 V / 0-20 mA / 4-20 mA etc.) folders available.

NOTE:

- **Pos.** stands for the position of the electronic module within the compact I/O module.
- **xx** is the index number of the electronic module position (from 00 to 04).

The table below provides the I/O electronic module type associated with the positions 0 to 4 (**Pos.00** to **Pos.04**) on the TM5C24D18T compact I/O module:

I/O Electronic Module Position	Type	Refer to
Pos.00	12 digital inputs	Configuration of the digital input 12In electronic modules (see page 58).
Pos.01	12 digital inputs	
Pos.02	6 digital outputs	Configuration of the digital output 6Out electronic modules (see page 60).
Pos.03	6 digital outputs	
Pos.04	6 digital outputs	

For further generic descriptions, refer to I/O Configuration Tab Description (see page 26).

I/O Mapping Tab

Variables can be defined and named in the **I/O Mapping** tab. Additional information such as topological addressing is also provided in this tab.

Refer to the following paragraphs:

- Input Mapping ([see page 34](#)), for the input parameters configuration details.
- Output Mapping ([see page 35](#)), for the output parameters configuration details.

For further generic descriptions, refer to I/O Mapping Tab Description ([see page 26](#)).

Input Mapping

This table describes the TM5C24D18T input mapping configuration:

Channel	Type	Description
Pos0_DigitalInputs00	UINT	State of all inputs (bits 12-15 = 0, not used) of the integrated electronic module located at Pos.00
DigitalInput00	BOOL	State of input 0
...		...
DigitalInput11		State of input 11
Pos1_DigitalInputs00	UINT	State of all inputs (bits 12-15 = 0, not used) of the integrated electronic module located at Pos.01
DigitalInput00	BOOL	State of input 0
...		...
DigitalInput11		State of input 11
Pos2_StatusDigitalOutputs	USINT	Status word of all outputs of the integrated electronic module located at Pos.02
StatusDigitalOutput00	BOOL	Status bit associated to each output: <ul style="list-style-type: none"> ● 0: OK ● 1: error detected
...		
StatusDigitalOutput05		
Pos3_StatusDigitalOutputs	USINT	Status word of all outputs of the integrated electronic module located at Pos.03
StatusDigitalOutput00	BOOL	Status bit associated to each output: <ul style="list-style-type: none"> ● 0: OK ● 1: error detected
...		
StatusDigitalOutput05		
Pos4_StatusDigitalOutputs	USINT	Status word of all outputs of the integrated electronic module located at Pos.04
StatusDigitalOutput00	BOOL	Status bit associated to each output: <ul style="list-style-type: none"> ● 0: OK ● 1: error detected
...		
StatusDigitalOutput05		

Channel	Type	Description
GlobalModuleStatusInputs	UINT	State of the compact I/O and the electronic modules
StatusPos00	BOOL	State of the electronic module in position 0 (OK=1)
...		...
StatusPos04		State of the electronic module in position 4 (OK=1)
Not Used		Bit not used
GlobalModuleStatus		State of the compact I/O (OK=0)

Output Mapping

This table describes the TM5C24D18T output mapping configuration:

Channel	Type	Description
Pos2_DigitalOutputs	USINT	Command word of all outputs of the integrated electronic module located at Pos.02
DigitalOutput00	BOOL	Command bit of output 0
...		...
DigitalOutput05		Command bit of output 5
Pos3_DigitalOutputs	USINT	Command word of all outputs of the integrated electronic module located at Pos.03
DigitalOutput00	BOOL	Command bit of output 0
...		...
DigitalOutput05		Command bit of output 5
Pos4_DigitalOutputs	USINT	Command word of all outputs of the integrated electronic module located at Pos.04
DigitalOutput00	BOOL	Command bit of output 0
...		...
DigitalOutput05		Command bit of output 5

TM5C12D8T

Introduction

The TM5C12D8T compact I/O module is a set of 5 TM5 24 Vdc input and output electronic modules assembled together.

This set includes:

- 3 digital input electronic modules
- 2 digital output electronic modules

For further information, refer to the TM5C12D8T General Description (see *Modicon TM5, Compact I/O Modules, Hardware Guide*).

I/O Configuration Tab

To configure the TM5C12D8T compact I/O module, select the **I/O Configuration** tab.

This table describes the **General** parameters of the TM5C12D8T compact I/O module:

Parameter	Value	Default Value	Description
Module address	0...250	0	The address is automatically set when adding the compact I/O modules. The address value depends on the order of adding the module in the Devices tree . The compact I/O module does not support the possibility to change the address.

Set each of the I/O electronic modules individually using the **Pos.xx - SDEM** (SDEM = Short Description of the Electronic Module, like 12In, 6Out, 4AI ±10 V / 0-20 mA / 4-20 mA etc.) folders available.

NOTE:

- **Pos.** stands for the position of the electronic module within the compact I/O module.
- **xx** is the index number of the electronic module position (from 00 to 04).

This table provides the I/O electronic module type associated with the positions 0 to 4 (**Pos.00** to **Pos.04**) on the TM5C12D8T compact I/O module:

I/O Electronic Module Position	Type	Refer To
Pos.00	4 digital inputs	Configuration of the digital input 4In electronic modules (see page 56)
Pos.01	4 digital inputs	
Pos.02	4 digital inputs	
Pos.03	4 digital outputs	Configuration of the digital output 4Out electronic modules (see page 59)
Pos.04	4 digital outputs	

For further generic descriptions, refer to I/O Configuration Tab Description (see page 26).

I/O Mapping Tab

Variables can be defined and named in the **I/O Mapping** tab. Additional information such as topological addressing is also provided in this tab.

Refer to the following paragraphs:

- Input Mapping ([see page 37](#)), for the input parameters configuration details.
- Output Mapping ([see page 38](#)), for the output parameters configuration details.

For further generic descriptions, refer to I/O Mapping Tab Description ([see page 26](#)).

Input Mapping

This table describes the TM5C12D8T input mapping configuration:

Channel	Type	Description
Pos0_DigitalInputs	USINT	State of all inputs (bits 4-7 = 0, not used) of the integrated electronic module located at Pos.00
DigitalInput00	BOOL	State of input 0
...		...
DigitalInput03		State of input 03
Pos1_DigitalInputs	USINT	State of all inputs (bits 4-7 = 0, not used) of the integrated electronic module located at Pos.01
DigitalInput00	BOOL	State of input 0
...		...
DigitalInput03		State of input 3
Pos2_DigitalInputs	USINT	State of all inputs (bits 4-7 = 0, not used) of the integrated electronic module located at Pos.02
DigitalInput00	BOOL	State of input 0
...		...
DigitalInput03		State of input 3
Pos3_StatusDigitalOutputs	USINT	Status word of all outputs of the integrated electronic module located at Pos.03 (bits 4...7: not used).
StatusDigitalOutput00	BOOL	Status bit associated to each output:
...		<ul style="list-style-type: none"> • 0: OK • 1: error detected
StatusDigitalOutput03		
Pos4_StatusDigitalOutputs	USINT	Status word of all outputs of the integrated electronic module located at Pos.04 (bits 4...7: not used).
StatusDigitalOutput00	BOOL	Status bit associated to each output:
...		<ul style="list-style-type: none"> • 0: OK • 1: error detected
StatusDigitalOutput03		

Channel	Type	Description
GlobalModuleStatusInputs	UINT	State of the compact I/O and the electronic modules
StatusPos00	BOOL	State of the electronic module in position 0 (OK=1)
...		...
StatusPos04		State of the electronic module in position 4 (OK=1)
Not used		Bit not used
GlobalModuleStatus		State of the compact I/O (OK=0)

Output Mapping

This table describes the TM5C12D8T output mapping configuration:

Channel	Type	Description
Pos3_DigitalOutputs	USINT	Command word of all outputs of the integrated electronic module located at Pos.03 (bits 4...7: not used).
DigitalOutput00	BOOL	Command bit of output 0
...		...
DigitalOutput03		Command bit of output 3
Pos4_DigitalOutputs	USINT	Command word of all outputs of the integrated electronic module located at Pos.04 (bits 4...7: not used).
DigitalOutput00	BOOL	Command bit of output 0
...		...
DigitalOutput03		Command bit of output 3

TM5C12D6T6L

Introduction

The TM5C12D6T6L compact I/O module is a set of 5 TM5 24 Vdc input and output electronic modules assembled together.

This set includes:

- 2 digital input electronic modules
- 1 digital output electronic module
- 1 analog input electronic module
- 1 analog output electronic module

For further information, refer to the TM5C12D6T6L General Description (*see Modicon TM5, Compact I/O Modules, Hardware Guide*).

I/O Configuration Tab

To configure the TM5C12D6T6L compact I/O module, select the **I/O Configuration** tab.

This table describes the **General** parameters of the TM5C12D6T6L compact I/O module:

Parameter	Value	Default Value	Description
Module address	0...250	0	The address is automatically set when adding the compact I/O modules. The address value depends on the order of adding the module in the Devices tree . The compact I/O module does not support the possibility to change the address.

Set each of the I/O electronic modules individually using the **Pos.xx - SDEM** (SDEM = Short Description of the Electronic Module, like 12In, 6Out, 4AI ± 10 V / 0-20 mA / 4-20 mA etc.) folders available.

NOTE:

- **Pos.** stands for the position of the electronic module on the compact I/O electronic module.
- **xx** is the index number of the electronic module position (from 00 to 04).

This table provides the I/O electronic module type associated with the positions 0 to 4 (**Pos.00** to **Pos.04**) on the TM5C12D6T6L compact I/O module:

I/O Electronic Module Position	Type	Refer To
Pos.00	6 digital inputs	Configuration of the digital input 6In electronic modules (see page 57)
Pos.01	6 digital inputs	
Pos.02	6 digital outputs	Configuration of the digital output 6Out electronic module (see page 60)
Pos.03	4 analog inputs	Configuration of the analog input 4AI ± 10 V / 0-20 mA / 4-20 mA electronic module (see page 64)
Pos.04	2 analog outputs	Configuration of the analog output 2AO ± 10 V / 0-20 mA electronic module (see page 74)

For further generic descriptions, refer to I/O Configuration Tab Description ([see page 26](#)).

I/O Mapping Tab

Variables can be defined and named in the **I/O Mapping** tab. Additional information such as topological addressing is also provided in this tab.

Refer to the following paragraphs:

- Input Mapping ([see page 41](#)), for the input parameters configuration details.
- Output Mapping ([see page 42](#)), for the output parameters configuration details.

For further generic descriptions, refer to I/O Mapping Tab Description ([see page 26](#)).

Input Mapping

This table describes the TM5C12D6T6L input mapping configuration:

Channel	Type	Description
Pos0_DigitalInputs	USINT	State of all inputs (bits 6-7 = 0, not used) of the integrated electronic module located at Pos.00
DigitalInput00	BOOL	State of input 0
...		...
DigitalInput05		State of input5
Pos1_DigitalInputs	USINT	State of all inputs (bits 6-7 = 0, not used) of the integrated electronic module located at Pos.01
DigitalInput00	BOOL	State of input 0
...		...
DigitalInput05		State of input 5
Pos2_StatusDigitalOutputs	USINT	Status word of all outputs of the integrated electronic module located at Pos.02 (bits 6...7: not used).
DigitalInput00	BOOL	Status bit associated to each output:
...		<ul style="list-style-type: none"> ● 0: OK ● 1: error detected
DigitalInput05		
Pos3_AnalogInput00	INT	Current value of input 0
...		...
Pos3_AnalogInput03		Current value of input 3
Pos3_StatusInput	USINT	State of all inputs
GlobalModuleStatusInputs	UINT	State of the compact I/O and the electronic modules
StatusPos00	BOOL	State of the electronic module in position 0 (OK=1)
...		...
StatusPos04		State of the electronic module in position 4 (OK=1)
Not used		Bit not used
GlobalModuleStatus		State of the compact I/O (OK=0)

Output Mapping

This table describes the TM5C12D6T6L output mapping configuration:

Channel	Type	Description
Pos2_DigitalOutputs	USINT	Command word of all outputs of the integrated electronic module located at Pos.02 (bits 6...7: not used).
DigitalOutput00	BOOL	Command bit of output 0
...		...
DigitalOutput05		Command bit of output 5
Pos4_AnalogOutput00	INT	Command word of the output 0
Pos4_AnalogOutput01	INT	Command word of the output 1

TM5C24D12R

Introduction

The TM5C24D12R compact I/O module is a set of 5 TM5 24 Vdc input and output electronic modules assembled together.

This set includes:

- 2 digital input electronic modules
- 2 relay electronic modules
- 1 dummy module (see *Modicon TM5, Compact I/O Modules, Hardware Guide*).

For further information, refer to the TM5C24D12R General Description (see *Modicon TM5, Compact I/O Modules, Hardware Guide*).

I/O Configuration Tab

To configure the TM5C24D12R compact I/O module, select the **I/O Configuration** tab.

This table describes the **General** parameters of the TM5C24D12R compact I/O module:

Parameter	Value	Default Value	Description
Module address	0...250	0	The address is automatically set when adding the compact I/O modules. The address value depends on the order of adding the module in the Devices tree . The compact I/O module does not support the possibility to change the address.

Set each of the I/O electronic modules individually using the **Pos.xx - SDEM** (SDEM = Short Description of the Electronic Module, like 12In, 6Out, 4AI ± 10 V / 0-20 mA / 4-20 mA etc.) folders available.

NOTE:

- **Pos.** stands for the position of the electronic module within the compact I/O module.
- **xx** is the index number of the electronic module position (from 00 to 04).

This table provides the I/O electronic module type associated with the positions 0 to 4 (**Pos.00** to **Pos.04**) on the TM5C24D12R compact I/O module:

I/O Electronic Module Position	Type	Refer To
Pos.00	12 digital inputs	Configuration of the digital input 12In electronic modules (see page 58)
Pos.01	12 digital inputs	
Pos.02	6 relay outputs	Configuration of the digital output relay 6Rel electronic modules (see page 61)
Pos.04	6 relay outputs	

NOTE: Pos.03 does not appear in the **I/O Configuration** tab as this is the dummy module that cannot be configured.

For further generic descriptions, refer to I/O Configuration Tab Description ([see page 26](#)).

I/O Mapping Tab

Variables can be defined and named in the **I/O Mapping** tab. Additional information such as topological addressing is also provided in this tab.

Refer to the following paragraphs:

- Input Mapping ([see page 44](#)), for the input parameters configuration details.
- Output Mapping ([see page 45](#)), for the output parameters configuration details.

For further generic descriptions, refer to I/O Mapping Tab Description ([see page 26](#)).

Input Mapping

This table describes the TM5C24D12R I/O Mapping configuration:

Channel	Type	Description
Pos0_DigitalInput	UINT	State of all inputs (bits 12-15 = 0, not used) of the integrated electronic module located at Pos.00
DigitalInput00	BOOL	State of input 0
...		...
DigitalInput11		State of input 11
Pos1_DigitalInputs00	UINT	State of all inputs (bits 12-15 = 0, not used) of the integrated electronic module located at Pos.01
DigitalInput00	BOOL	State of input 0
...		...
DigitalInput11		State of input 11
GlobalModuleStatusInputs	UINT	State of the compact I/O and the electronic modules
StatusPos00	BOOL	State of the electronic module in position 0 (OK=1)
...		...
StatusPos04		State of the electronic module in position 4 (OK=1)
Not used		Bit not used
GlobalModuleStatus		State of the compact I/O (OK=0)

Output Mapping

This table describes the TM5C24D12R I/O Mapping configuration:

Channel			Description
Pos2_DigitalOutputs		UINT	Command word of all outputs of the integrated electronic module located at Pos.02
	DigitalOutput00	BOOL	Command bit of output 0

	DigitalOutput05		Command bit of output 5
Pos4_DigitalOutputs		UINT	Command word of all outputs of the integrated electronic module located at Pos.04
	DigitalOuput00	BOOL	Command bit of output 0

	DigitalOutput05		Command bit of output 5

TM5CAI8O8VL

Introduction

The TM5CAI8O8VL compact I/O module is a set of 4 TM5 24 Vdc input and output electronic modules assembled together.

This set includes:

- 2 analog input electronic module
- 1 dummy module (*see Modicon TM5, Compact I/O Modules, Hardware Guide*)
- 2 analog output electronic module

For further information, refer to the TM5CAI8O8VL General Description (*see Modicon TM5, Compact I/O Modules, Hardware Guide*).

I/O Configuration Tab

To configure the TM5CAI8O8VL compact I/O module, select the **I/O Configuration** tab.

This table describes the **General** parameters of the TM5CAI8O8VL compact I/O module:

Parameter	Value	Default Value	Description
Module address	0...250	0	The address is automatically set when adding the compact I/O modules. The address value depends on the order of adding the module in the Devices tree . The compact I/O modules does not support the possibility to change the address.

Set each of the I/O electronic modules individually using the **Pos.xx - SDEM** (SDEM = Short Description of the Electronic Module, like 12In, 6Out, 4AI ±10 V / 0-20 mA / 4-20 mA etc.) folders available.

NOTE:

- **Pos.** stands for the position of the electronic module on the compact I/O electronic module.
- **xx** is the index number of the electronic module position (from 00 to 04).

This table provides the I/O electronic module type associated with the positions 0 to 4 (**Pos.00** to **Pos.04**) on the TM5CAI8O8VL compact I/O module:

I/O Electronic Module Position	Type	Refer to
Pos.00	4 analog inputs	Configuration of the analog input 4AI ±10 V electronic modules (<i>see page 62</i>)
Pos.01	4 analog inputs	
Pos.03	4 analog outputs	Configuration of the analog output 4AO ±10 V electronic module (<i>see page 72</i>)
Pos.04	4 analog outputs	

NOTE: Pos.02 does not appear in the **I/O Configuration** tab as this is the dummy module that cannot be configured.

For further generic descriptions, refer to I/O Configuration Tab Description ([see page 26](#)).

I/O Mapping Tab

Variables can be defined and named in the **I/O Mapping** tab. Additional information such as topological addressing is also provided in this tab.

Refer to the following paragraphs:

- Input Mapping ([see page 47](#)), for the input parameters configuration details.
- Output Mapping ([see page 48](#)), for the output parameters configuration details.

For further generic descriptions, refer to I/O Mapping Tab Description ([see page 26](#)).

Input Mapping

This table describes the TM5CAI8O8VL input mapping configuration:

Channel	Type	Description
Pos0_AnalogInput00	INT	Current value of input 0
...		...
Pos0_AnalogInput03		Current value of input 3
Pos0_StatusInput	USINT	Status of the analog inputs
Pos1_AnalogInput00	INT	Current value of input 0
...		...
Pos1_AnalogInput03		Current value of input 3
Pos1_StatusInput	USINT	Status of the analog inputs
GlobalModuleStatusInputs	UINT	State of the compact I/O and the electronic modules
StatusPos00	BOOL	State of the electronic module in position 0 (OK=1)
StatusPos01		State of the electronic module in position 1 (OK=1)
Not Used		Bit not used
StatusPos03		State of the electronic module in position 3 (OK=1)
StatusPos04		State of the electronic module in position 4 (OK=1)
Not Used		Bit not used
GlobalModuleStatus		State of the compact I/O (OK=0)

Output Mapping

This table describes the TM5CAI8O8VL output mapping configuration:

Channel	Type	Description
Pos3_AnalogOutput00	INT	Command word of the output 0
...		...
Pos3_AnalogOutput03		Command word of the output 3
Pos4_AnalogOutput00	INT	Command word of the output 0
...		...
Pos4_AnalogOutput03		Command word of the output 3

TM5CAI8O8CL

Introduction

The TM5CAI8O8CL compact I/O module is a set of 4 TM5 24 Vdc input and output electronic modules assembled together.

This set includes:

- 2 analog input electronic modules
- 1 dummy module (see *Modicon TM5, Compact I/O Modules, Hardware Guide*)
- 2 analog output electronic modules

For further information, refer to the TM5CAI8O8CL General Description (see *Modicon TM5, Compact I/O Modules, Hardware Guide*).

I/O Configuration Tab

To configure the TM5CAI8O8CL compact I/O module, select the **I/O Configuration** tab.

This table describes the **General** parameters of the TM5CAI8O8CL compact I/O module:

Parameter	Value	Default Value	Description
Module address	0...250	0	The address is automatically set when adding the compact I/O modules. The address value depends on the order of adding the module in the Devices tree . The compact I/O modules does not support the possibility to change the address.

Set each of the I/O electronic modules individually using the **Pos.xx - SDEM** (SDEM = Short Description of the Electronic Module, like 12In, 6Out, 4AI ± 10 V / 0-20 mA / 4-20 mA etc.) folders available.

NOTE:

- **Pos.** stands for the position of the electronic module on the compact I/O electronic module.
- **xx** is the index number of the electronic module position (from 00 to 04).

This table provides the I/O electronic module type associated with the positions 0 to 4 (**Pos.00** to **Pos.04**) on the TM5CAI8O8CL compact I/O module:

I/O Electronic Module Position	Type	Refer To
Pos.00	4 analog inputs	Configuration of the analog input 4AI 0-20 mA / 4-20 mA electronic modules (see page 63)
Pos.01	4 analog inputs	
Pos.03	4 analog outputs	Configuration of the analog output 4AO 0-20 mA electronic module (see page 73)
Pos.04	4 analog outputs	

NOTE: Pos.02 does not appear in the **I/O Configuration** tab as this is the dummy module that cannot be configured.

For further generic descriptions, refer to I/O Configuration Tab Description ([see page 26](#)).

I/O Mapping Tab

Variables can be defined and named in the **I/O Mapping** tab. Additional information such as topological addressing is also provided in this tab.

Refer to the following paragraphs:

- Input Mapping for the input parameters configuration details.
- Output Mapping, for the output parameters configuration details.

For further generic descriptions, refer to I/O Mapping Tab Description ([see page 26](#)).

Input Mapping

This table describes the TM5CAI8O8CL input mapping configuration:

Channel	Type	Description
Pos0_AnalogInput00	INT	Current value of input 0
...		...
Pos0_AnalogInput03		Current value of input 3
Pos0_StatusInput	USINT	State of all inputs
Pos1_AnalogInput00	INT	Current value of input 0
...		...
Pos1_AnalogInput03		Current value of input 3
Pos1_StatusInput	USINT	State of all inputs
GlobalModuleStatusInputs	UINT	State of the compact I/O and the electronic modules
StatusPos00		State of the electronic module in position 0 (OK=1)
StatusPos01		State of the electronic module in position 1 (OK=1)
Not Used		Bit not used
StatusPos03		State of the electronic module in position 3 (OK=1)
StatusPos04		State of the electronic module in position 4 (OK=1)
Not Used		Bit not used
GlobalModuleStatus		State of the compact I/O (OK=0)

Output Mapping

This table describes the TM5CAI8O8CL output mapping configuration:

Channel	Type	Description
Pos3_AnalogOutput00	INT	Command word of the output 0
...		...
Pos3_AnalogOutput03		Command word of the output 3
Pos4_AnalogOutput00	INT	Command word of the output 0
...		...
Pos4_AnalogOutput03		Command word of the output 3

TM5CAI8O8CVL

Introduction

The TM5CAI8O8CVL compact I/O module is a set of 4 TM5 24 Vdc input and output electronic modules assembled together.

This set includes:

- 2 analog input electronic modules
- 1 dummy module (*see Modicon TM5, Compact I/O Modules, Hardware Guide*)
- 2 analog output electronic modules

For further information, refer to the TM5CAI8O8CVL General Description (*see Modicon TM5, Compact I/O Modules, Hardware Guide*).

I/O Configuration Tab

To configure the TM5CAI8O8CVL compact I/O module, select the **I/O Configuration** tab.

This table describes the **General** parameters of the TM5CAI8O8CVL compact I/O module:

Parameter	Value	Default Value	Description
Module address	0...250	0	The address is automatically set when adding the compact I/O modules. The address value depends on the order of adding the module in the Devices tree . The compact I/O modules does not support the possibility to change the address.

Set each of the I/O electronic modules individually using the **Pos.xx - SDEM** (SDEM = Short Description of the Electronic Module, like 12In, 6Out, 4AI ± 10 V / 0-20 mA / 4-20 mA etc.) folders available.

NOTE:

- **Pos.** stands for the position of the electronic module on the compact I/O electronic module.
- **xx** is the index number of the electronic module position (from 00 to 04).

This table provides the I/O electronic module type associated with the positions 0 to 4 (**Pos.00** to **Pos.04**) on the TM5CAI8O8CVL compact I/O module:

I/O Electronic Module Position	Type	Refer To
Pos.00	4 analog inputs	Configuration of the analog input 4AI ± 10 V electronic modules (<i>see page 62</i>)
Pos.01	4 analog inputs	Configuration of the analog input 4AI 0-20 mA / 4-20 mA electronic modules (<i>see page 63</i>)
Pos.03	4 analog outputs	Configuration of the analog output 4AO ± 10 V electronic module (<i>see page 72</i>)
Pos.04	4 analog outputs	Configuration of the analog output 4AO 0-20 mA electronic module (<i>see page 73</i>)

NOTE: Pos.02 does not appear in the **I/O Configuration** tab as this is the dummy module that cannot be configured.

For further generic descriptions, refer to I/O Configuration Tab Description (*see page 26*).

I/O Mapping Tab

Variables can be defined and named in the **I/O Mapping** tab. Additional information such as topological addressing is also provided in this tab.

Refer to the following paragraphs:

- Input Mapping for the input parameters configuration details.
- Output Mapping, for the output parameters configuration details.

For further generic descriptions, refer to I/O Mapping Tab Description (*see page 26*).

Input Mapping

This table describes the TM5CAI8O8CVL input mapping configuration:

Channel	Type	Description
Pos0_AnalogInput00	INT	Current value of input 0
...		...
Pos0_AnalogInput03		Current value of input 3
Pos0_StatusInput	USINT	State of all inputs
Pos1_AnalogInput00	INT	Current value of input 0
...		...
Pos1_AnalogInput03		Current value of input 3
Pos1_StatusInput	USINT	State of all inputs
GlobalModuleStatusInputs	UINT	State of the compact I/O and the electronic modules
StatusPos00	BOOL	State of the electronic module in position 0 (OK=1)
StatusPos01		State of the electronic module in position 1 (OK=1)
Not Used		Bit not used
StatusPos03		State of the electronic module in position 3 (OK=1)
StatusPos04		State of the electronic module in position 4 (OK=1)
Not Used		Bit not used
GlobalModuleStatus		State of the compact I/O (OK=0)

Output Mapping

This table describes the TM5CAI8O8CVL output mapping configuration:

Channel	Type	Description
Pos3_AnalogOutput00	INT	Command word of the output 0
...		...
Pos3_AnalogOutput03		Command word of the output 3
Pos4_AnalogOutput00	INT	Command word of the output 0
...		...
Pos4_AnalogOutput03		Command word of the output 3

Section 2.2

Integrated Electronic Modules

Introduction

This section provides the electronic modules parameters available in order to configure the compact I/O modules.

What Is in This Section?

This section contains the following topics:

Topic	Page
Digital Input 4In	56
Digital Input 6In	57
Digital Input 12In	58
Digital Output 4Out	59
Digital Output 6Out	60
Digital Output Relay 6Rel	61
Analog Input 4AI ± 10 V	62
Analog Input 4AI 0-20 mA / 4-20 mA	63
Analog Input 4AI ± 10 V / 0-20 mA / 4-20 mA	64
Analog Output 4AO ± 10 V	72
Analog Output 4AO 0-20 mA	73
Analog Output 2AO ± 10 V / 0-20 mA	74

Digital Input 4In

Overview

The Digital Input 4In electronic module is a 24 Vdc electronic module with 4 inputs.

For further information, refer to the description of this electronic module in the Compact I/O Modules Hardware Guide (see *Modicon TM5, Compact I/O Modules, Hardware Guide*).

I/O Configuration

This table describes the 4In electronic module parameters configuration:

Parameter	Value	Default Value	Description
Input filter	0...250	10	Specifies the filter time of all digital inputs in the range 0...250 (0...25 ms).
24V I/O segment external current	0...500 mA	200 mA	Current derived from the 24 Vdc I/O power segment to supply the sensors connected to the module. This value is used to balance current consumption on the 24Vdc I/O power segment (see <i>Modicon TM5 / TM7 Flexible System, System Planning and Installation Guide</i>). This value is used exclusively in the calculation of the Check Resources function.

Cycle Time and I/O Update Time

This table gives the module characteristics allowing the TM5 Bus Cycle Time configuration:

Characteristic	Value (µs)	
	Without filter	With filter
Minimum cycle time	100	150
Minimum I/O update time	100	200

For further information, refer to TM5 Manager Configuration (see [page 23](#)).

Digital Input 6In

Overview

The Digital Input 6In electronic module is a 24 Vdc electronic module with 6 inputs.

For further information, refer to the description of this electronic module in the Compact I/O Modules Hardware Guide (see *Modicon TM5, Compact I/O Modules, Hardware Guide*).

I/O Configuration

The table below describes the 6In electronic module parameters configuration:

Parameter	Value	Default Value	Description
Input filter	0...250	10	Specifies the filter time of all digital inputs in the range 0...250 (0...25 ms).

Cycle Time and I/O Update Time

The table below gives the module characteristics allowing the TM5 Bus Cycle Time configuration:

Characteristic	Value (µs)	
	Without filter	With filter
Minimum cycle time	100	150
Minimum I/O update time	100	200

For further information, refer to TM5 Manager Configuration ([see page 23](#)).

Digital Input 12In

Overview

The Digital Input 12In electronic module is a 24 Vdc electronic module with 12 inputs.

For further information, refer to the description of this electronic module in the Compact I/O Modules Hardware Guide (see *Modicon TM5, Compact I/O Modules, Hardware Guide*).

I/O Configuration

The table below describes the 12In electronic module parameters configuration:

Parameter	Value	Default Value	Description
Input filter	0...250	10	Specifies the filter time of all digital inputs in the range 0...250 (0...25 ms).

Cycle Time and I/O Update Time

The table below gives the module characteristics allowing the TM5 Bus Cycle Time configuration:

Characteristic	Value (µs)	
	Without filter	With filter
Minimum cycle time	100	150
Minimum I/O update time	100	200

For further information, refer to TM5 Manager Configuration (see [page 23](#)).

Digital Output 4Out

Overview

The Digital Output 4Out electronic module is a 24 Vdc electronic module with 4 outputs.

For further information, refer to the description of this electronic module in the Compact I/O Modules Hardware Guide (see *Modicon TM5, Compact I/O Modules, Hardware Guide*).

I/O Configuration

This table describes the 4Out electronic module parameters configuration:

Parameter	Value	Default Value	Description
Output status information	off on	on	Enables or disables the output status reading function. When the value is set to ON, the status is displayed in the I/O Mapping tab. Status bit associated to each output: <ul style="list-style-type: none"> ● 0: OK ● 1: error detected, overload or short circuit
24V I/O segment external current	0...2500 mA	1200 mA	This value includes the current to supply actuators and the sum of the current for all outputs simultaneously activated. It is used to balance current consumption on the 24 Vdc I/O power segment (see <i>Modicon TM5 / TM7 Flexible System, System Planning and Installation Guide</i>). This value is used exclusively in the calculation of the Check Resources function.

Cycle Time and I/O Update Time

This table gives the module characteristics allowing the TM5 Bus Cycle Time configuration:

Characteristic	Value (µs)
Minimum cycle time	100
Minimum I/O update time	100

For further information, refer to TM5 Manager Configuration (see page 23).

Digital Output 6Out

Overview

The Digital Output 6Out electronic module is a 24 Vdc electronic module with 6 outputs.

For further information, refer to the description of this electronic module in the Compact I/O Modules Hardware Guide (see *Modicon TM5, Compact I/O Modules, Hardware Guide*).

I/O Configuration

This table describes the 6Out electronic module parameters configuration:

Parameter	Value	Default Value	Description
Output status information	off on	on	Enables or disables the output status reading function. When the value is set to ON, the status is displayed in the I/O Mapping tab. Status bit associated to each output: <ul style="list-style-type: none"> ● 0: OK ● 1: error detected, overload or short circuit
24V I/O segment external current	0...3000 mA	2000 mA	Current derived from the 24 Vdc I/O power segment. The value to set is the sum of current of all outputs simultaneously activated. It is used to balance current consumption on the 24 Vdc I/O power segment (see <i>Modicon TM5 / TM7 Flexible System, System Planning and Installation Guide</i>). This value is used exclusively in the calculation of the Check Resources function.

Cycle Time and I/O Update Time

This table gives the module characteristics allowing the TM5 Bus Cycle Time configuration:

Characteristic	Value (µs)
Minimum cycle time	100
Minimum I/O update time	100

For further information, refer to TM5 Manager Configuration (see page 23).

Digital Output Relay 6Rel

Overview

The Digital Output Relay 6Rel electronic module is equipped with 6 relay outputs.

For further information, refer to the description of this electronic module in the Compact I/O Modules Hardware Guide (see *Modicon TM5, Compact I/O Modules, Hardware Guide*).

I/O Configuration

The 6Rel electronic module does not have any I/O configuration parameter settings.

Analog Input 4AI ±10 V

Overview

The Analog Input 4AI ±10 V electronic module is equipped with 4 12-bit inputs.

For further information, refer to the description of this electronic module in the Compact I/O Modules Hardware Guide (see *Modicon TM5, Compact I/O Modules, Hardware Guide*).

I/O Configuration

No parameter settings are required in the **I/O Configuration** tab for the Analog Input 4AI ±10 V electronic module.

Status Input Register

The **Posx_StatusInput** (where x is the analog input electronic module position) byte describes the status of each input channel:

Bit	Description	Bits value
0-1	Channel 00 status	00: No error detected 11: Wire break
2-3	Channel 01 status	
4-5	Channel 02 status	
6-7	Channel 03 status	

Cycle Time and I/O Update Time

The table gives the module characteristics allowing the TM5 Bus Cycle Time configuration:

Characteristic	Value (µs)
Minimum cycle time	250
Minimum I/O update time	< 300

For further information, refer to TM5 Manager Configuration (see [page 23](#)).

Analog Input 4AI 0-20 mA / 4-20 mA

Overview

The Analog Input 4AI 0-20 mA / 4-20 mA electronic module is equipped with 4 12-bit inputs.

For further information, refer to the description of this electronic module in the Compact I/O Modules Hardware Guide (see *Modicon TM5, Compact I/O Modules, Hardware Guide*).

I/O Configuration

The table below describes the 4AI 0-20 mA / 4-20 mA electronic module parameters configuration:

Parameter	Value	Default Value	Description
Channel 00	0 to 20 mA 4 to 20 mA	0 to 20 mA	Specifies the channel type.
Channel 01	0 to 20 mA 4 to 20 mA	0 to 20 mA	
Channel 02	0 to 20 mA 4 to 20 mA	0 to 20 mA	
Channel 03	0 to 20 mA 4 to 20 mA	0 to 20 mA	

Status Input Register

The **Posx_StatusInput** (where x is the analog input electronic module position) byte describes the status of each input channel:

Bit	Description	Bits value
0-1	Channel 00 status	00: No error detected 11: Wire break
2-3	Channel 01 status	
4-5	Channel 02 status	
6-7	Channel 03 status	

Cycle Time and I/O Update Time

The table below gives the module characteristics allowing the TM5 Bus Cycle Time configuration:

Characteristic	Value (μ s)	
	Without filter	With filter
Minimum cycle time	100	500
Minimum I/O update time	300	1000

For further information, refer to TM5 Manager Configuration (see page 23).

Analog Input 4AI ± 10 V / 0-20 mA / 4-20 mA

Overview

The Analog Input 4AI ± 10 V / 0-20 mA / 4-20 mA electronic module is equipped with 4 12-bit inputs.

For further information, refer to the description of this electronic module in the Compact I/O Modules Hardware Guide (see *Modicon TM5, Compact I/O Modules, Hardware Guide*).

I/O Configuration

The table below describes the 4AI ± 10 V / 0-20 mA / 4-20 mA electronic module parameters configuration:

Parameter		Value	Default Value	Description
Lower limit (Minimum value)		-32768...32767	-32768	Specifies the lower measurement limit (see page 65).
Upper limit (Maximum value)		-32768...32767	32767	Specifies the upper measurement limit (see page 65).
Input filter		off on	off	Enables / Disables the input filter (see page 67).
Input limitation		off 16383 8191 4095 2047 1023 511 255	off	Defines the input ramp limitation (see page 69). NOTE: This Input limitation parameter is only accessible when the Input filter parameter is activated.
Channel 00	Channel type	± 10 V 0 to 20 mA 4 to 20 mA	± 10 V	Specifies the channel type.
Channel 01	Channel type	± 10 V 0 to 20 mA 4 to 20 mA	± 10 V	Specifies the channel type.
Channel 02	Channel type	± 10 V 0 to 20 mA 4 to 20 mA	± 10 V	Specifies the channel type.
Channel 03	Channel type	± 10 V 0 to 20 mA 4 to 20 mA	± 10 V	Specifies the channel type.

Analog Inputs

The input status is registered with a fixed offset with respect to the network cycle and is transferred in the same cycle.

Input Cycle

The electronic module is equipped with a configurable Input cycle. Filtering is deactivated for shorter cycle times.

If the Input cycle is active, then the channels are scanned in ms cycles. The time offset between the channels is 200 μ s. The conversion takes place asynchronously to the network cycle. Refer to Cycle time and I/O update time (*see page 71*).

Limit values

You can define 2 different type of limits:

- **Lower limit**
- **Upper limit**

The **Lower limit** value range is between -32768 to 32767. This value is applied on every channel of the module being configured.

NOTE: the **Lower limit** cannot be greater than the **Upper limit**.

Channel Configuration	Digital Value Behavior	Comments
$\pm 10V$	-10 V = -32768 +10 V = +32767	If the Lower limit value is configured between -32768 and +32767, the digital value is limited to the Lower limit value.
0 to 20 mA	0 mA = 0 20 mA = +32767	If the Lower limit value is configured between -32768 and 0, the digital value is limited to 0. If the Lower limit value is configured between 0 and 32 767, the digital value is limited to the Lower limit value.
4 to 20 mA	0 mA = 0 4 mA = 6554 20 mA = +32767	The module is configured to display the value between 0 and 32767 for 0...20 mA input range. If the input range is between 4 mA and 20 mA, the digital value is configured to display between 6554 and 32767. If the input range is between 0 mA and 4 mA, the digital value is configured to display between 0 and 6554. The Lower limit value is the same as other configuration channel in the range 0...20 mA.

The **Upper limit** value range is between -32768 to 32767 in $\pm 10 V$ configuration and 0 to 32767 in 0...20 mA and 4...20 mA configuration. This value is applied on every channel of the module being configured.

NOTE: The **Upper limit** value cannot be less than the **Lower limit** value.

Channel Configuration	Digital Value Behavior	Comments
± 10V	-10 V = -32768 +10 V = +32767	If the Upper limit value is configured between -32768 and +32767, the digital value is limited to the Upper limit value.
0 to 20 mA	0 mA = 0 20 mA = +32767	If the Upper limit value is configured between -32768 and 0, the digital value stays at 0, hence, the Upper limit value must be set to a positive value. If the Upper limit value is configured between 1 and +32767, the digital value is limited to the Upper limit value.
4 to 20 mA	0 mA = 0 4 mA = 6554 20 mA = +32767	If the Upper limit value is configured between -32768 and 0, the digital value is limited to 0. If the Upper limit value is configured between 0 and 32767, the digital value is limited to the Upper limit value.

Filter Level

The input value is evaluated according to the filter level. An input ramp limitation can then be applied using this evaluation.

Formula for the evaluation of the input value:

$$Value_{new} = Value_{old} - \frac{Value_{old}}{Filterlevel} + \frac{Inputvalue}{Filterlevel}$$

The following examples show the function of the input ramp limitation based on an input jump and a disturbance.

Example 1: The input value makes a jump from 8,000 to 16,000. The diagram displays the evaluated value with the following settings:

Input ramp limitation = 0

Filter level = 2 or 4

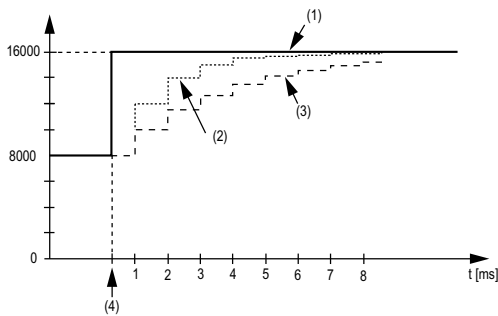

- 1 Input value
- 2 Evaluated value: Filter level 2
- 3 Evaluated value: Filter level 4
- 4 Input jump

Example 2: A disturbance is imposed on the input value. The diagram shows the evaluated value with the following settings:

Input ramp limitation = 0

Filter level = 2 or 4

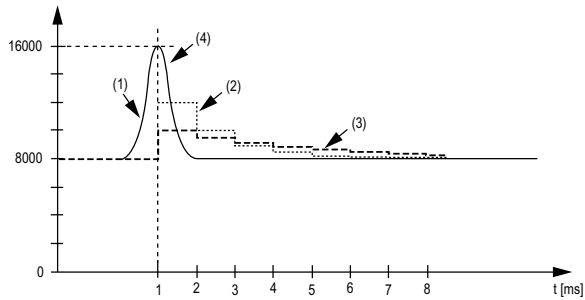

- 1 Input value.
- 2 Evaluated value: Filter level 2
- 3 Evaluated value: Filter level 4
- 4 Disturbance (Spike)

Input Ramp Limitation

Input ramp limitation can only take place when a filter is used. Input ramp limitation is executed before filtering takes place.

The amount of the change in the input value is checked to make sure the specified limits are not exceeded. If the values are exceeded, the adjusted input value is equal to the old value \pm the limit value.

The input ramp limitation is well suited for suppressing disturbances (spikes). The following examples show the function of the input ramp limitation based on an input jump and a disturbance.

Example 1: The input value makes a jump from 8,000 to 17,000. The diagram displays the adjusted input value for the following settings:

Input ramp limitation = 2047

Filter level = 2

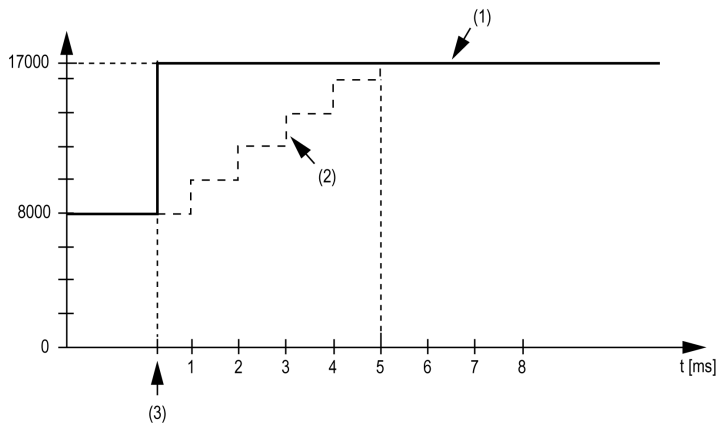

- 1 Input value
- 2 Internal adjusted input value before filter
- 3 Input jump

Example 2: A disturbance is imposed on the input value. The diagram shows the adjusted input value with the following settings:

Input ramp limitation = 2047

Filter level = 2

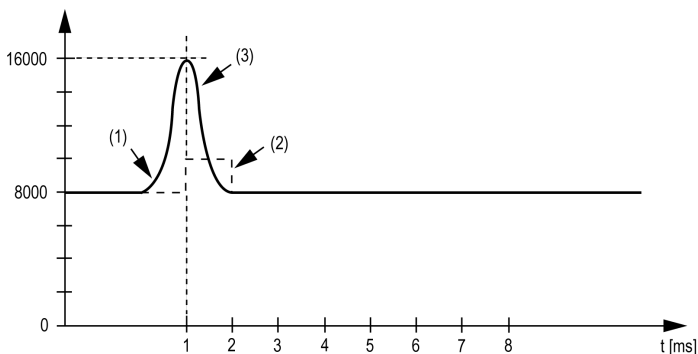

- 1 Input value
- 2 Internal adjusted input value before filter
- 3 Disturbance (Spike)

Status Input Register

The **Posx_StatusInput** (where x is the analog input electronic module position) byte describes the status of each input channel:

Bit	Description	Bits value
0-1	Channel 00 status	00: No error detected
2-3	Channel 01 status	01: Below lower limit value ¹
4-5	Channel 02 status	10: Above upper limit value
6-7	Channel 03 status	11: Wire break ²

¹
Current signal 0...20 mA
Default setting: The input value has a lower limit. Underflow monitoring is, therefore, not necessary.
After lower limit value changes: The input value is limited to the set value. The status bit is set when the lower limit value is passed.

²
Detects only if channel is configured to ± 10V

Cycle Time and I/O Update Time

The table below gives the module characteristics allowing the TM5 Bus Cycle Time configuration:

Characteristic	Value (μs)	
	Without filter	With filter
Minimum cycle time	100	500
Minimum I/O update time	300	1000

For further information, refer to TM5 Manager Configuration ([see page 23](#)).

Analog Output 4AO ± 10 V

Overview

The Analog Output 4AO ± 10 V electronic module is equipped with 4 12-bit outputs.

For further information, refer to the description of this electronic module in the Compact I/O Modules Hardware Guide (see *Modicon TM5, Compact I/O Modules, Hardware Guide*).

I/O Configuration

No parameter settings are required in the **I/O Configuration** tab for the Analog Output 4AO ± 10 V electronic module.

Cycle Time and I/O Update Time

The table gives the module characteristics allowing the TM5 Bus Cycle Time configuration:

Characteristic	Value (μ s)
Minimum cycle time	250
Minimum I/O update time	< 300

For further information, refer to TM5 Manager Configuration (see [page 23](#)).

Analog Output 4AO 0-20 mA

Overview

The Analog Output 4AO 0-20 mA electronic module is equipped with 4 12-bit outputs.

For further information, refer to the description of this electronic module in the Compact I/O Modules Hardware Guide (see *Modicon TM5, Compact I/O Modules, Hardware Guide*).

I/O Configuration

No parameter settings are required in the **I/O Configuration** tab for the Analog Output 4AO 0-20 mA electronic module.

Cycle Time and I/O Update Time

The table gives the module characteristics allowing the TM5 Bus Cycle Time configuration:

Characteristic	Value (μ s)
Minimum cycle time	250
Minimum I/O update time	< 300

For further information, refer to TM5 Manager Configuration (see [page 23](#)).

Analog Output 2AO ±10 V / 0-20 mA

Overview

The Analog Output 2AO ±10 V / 0-20 mA electronic module is equipped with 2 12-bit outputs. For further information, refer to the description of this electronic module in the Compact I/O Modules Hardware Guide (see *Modicon TM5, Compact I/O Modules, Hardware Guide*).

I/O Configuration

The table below describes the 2AO ±10 V / 0-20 mA electronic module parameters configuration:

Parameter		Value	Default Value	Description
Channel 00	Channel type	± 10V 0 to 20mA	± 10V	Specifies the channel type.
Channel 01	Channel type	± 10V 0 to 20mA	± 10V	Specifies the channel type.

Cycle Time and I/O Update Time

The table below gives the module characteristics allowing the TM5 Bus Cycle Time configuration:

Characteristic	Value (µs)
Minimum cycle time	250
Minimum I/O update time	< 300

For further information, refer to TM5 Manager Configuration (see [page 23](#)).

Chapter 3

TM5 Digital I/O Electronic Modules

Introduction

This chapter provides information to configure digital I/O expansion electronic modules.

To add expansion electronic modules, and to access the configuration screens, refer to Adding an expansion electronic module ([see page 26](#)).

What Is in This Chapter?

This chapter contains the following topics:

Topic	Page
TM5SDI2D, TM5SDI4D and TM5SDI6D	76
TM5SDI2A, TM5SDI4A and TM5SDI6U	79
TM5SDI12D	81
TM5SDI16D	83
TM5SDI2DF	85
TM5SDO2T, TM5SDO4T, TM5SDO6T, TM5SDO12T, and TM5SDO16T	90
TM5SDO4TA and TM5SDO8TA	93
TM5SDO2R and TM5SDO4R	95
TM5SDO2S	97
TM5SDM12DT	99
TM5SMM6D2L	101

TM5SDI2D, TM5SDI4D and TM5SDI6D

Introduction

The TM5SDI2D, TM5SDI4D and TM5SDI6D expansion electronic modules are 24 Vdc digital input electronic modules with 2, 4 and 6 inputs respectively.

For further information, refer to the hardware guide:

Reference	Refer to
TM5SDI2D	TM5SDI2D Electronic Module 2DI 24 Vdc Sink 3 Wires (see <i>Modicon TM5, Digital I/O Modules, Hardware Guide</i>)
TM5SDI4D	TM5SDI4D Electronic Module 4DI 24 Vdc Sink 3 Wires (see <i>Modicon TM5, Digital I/O Modules, Hardware Guide</i>)
TM5SDI6D	TM5SDI6D Electronic Module 6DI 24 Vdc Sink 2 Wires (see <i>Modicon TM5, Digital I/O Modules, Hardware Guide</i>)

I/O Configuration Tab

To configure the TM5SDI2D, TM5SDI4D and TM5SDI6D electronic modules, select the **I/O configuration** tab.

This table describes the configuration the module parameters:

Parameter	Value	Default Value	Unit	Description
Module address	0...250	Depends on the configuration	-	The address is automatically set when adding the modules. The address value depends on the order of adding the module in the SoMachine tree. The TM5ACBM15 supports the possibility to change the address.
Input filter	0...250	10 (1 ms)	0.1 ms	Specifies the filter time of all digital inputs in the range 0...250 (0...25 ms).
Bus base	TM5ACBM15 TM5ACBM11	TM5ACBM11	-	Specifies the bus base associated with the electronic module.
Terminal block	TM5ACTB06 (not for TM5SDI4D) TM5ACTB12	TM5ACTB06 (TM5ACTB12 for TM5SDI4D)	-	Specifies the terminal block associated with the electronic module.

Parameter	Value	Default Value	Unit	Description
24 V I/O segment external current (Only for TM5SDI2D and TM5SDI4D)	0...500	100 mA (for TM5SDI2D) 200 mA (for TM5SDI4D)	-	Current derived from the 24 Vdc I/O power segment to supply the sensors connected to the module. This value is used to balance current consumption on the 24Vdc I/O power segment (see <i>Modicon TM5 / TM7 Flexible System, System Planning and Installation Guide</i>). This value is used exclusively in the calculation of the Check Resources function.

For further generic descriptions, refer to I/O Configuration Tab Description (see page 26).

I/O Mapping Tab

Variables can be defined and named in the **I/O Mapping** tab. Additional information such as topological addressing is also provided in this tab.

This table describes the I/O mapping:

Variable	Channel	Type	Description
Inputs	DigitalInputs	USINT	State of all inputs (bits 6-7 = 0, not used)
	DigitalInput00	BOOL	State of input 0

	DigitalInput05 *		State of input 5

* The number of digital inputs is equal to the module input number.

For further generic descriptions, refer to I/O Mapping Tab Description (see page 26).

Cycle Time and I/O Update Time

This table gives the module characteristics allowing the TM5 bus cycle time configuration:

Characteristic	Value (μs)	
	Without Filter	With Filter
Minimum cycle time	100	150
Minimum I/O update time	100	200

For further information, refer to TM5 Manager Configuration ([see page 23](#)).

TM5SDI2A, TM5SDI4A and TM5SDI6U

Introduction

The TM5SDI2A, TM5SDI4A and TM5SDI6U expansion electronic modules are 100-240 Vac Input electronic modules with 2, 4 and 6 inputs respectively.

For further information, refer to the Hardware Guide:

Reference	Refer to
TM5SDI2A	TM5SDI2A Electronic Module 2DI 100 ... 240 Vac 3 Wires (see <i>Modicon TM5, Digital I/O Modules, Hardware Guide</i>)
TM5SDI4A	TM5SDI4A Electronic Module 4DI 100 ... 240 Vac 2 Wires (see <i>Modicon TM5, Digital I/O Modules, Hardware Guide</i>)
TM5SDI6U	TM5SDI6U Electronic Module 6DI 100 ... 120 Vac 1 Wire (see <i>Modicon TM5, Digital I/O Modules, Hardware Guide</i>)

I/O Configuration Tab

To configure the TM5SDI2A, TM5SDI4A and TM5SDI6U electronic modules, select the **I/O configuration** tab.

This table describes the modules parameters configuration:

Parameter	Value	Default Value	Unit	Description
Input filter	0...250	10 (1 ms)	0.1 ms	Specifies the filter time of all digital inputs in the range 0...250 (0...25 ms).
Bus base	TM5ACBM12	TM5ACBM12	-	Specifies the bus base associated with the electronic module.
Terminal block	TM5ACTB32	TM5ACTB32	-	Specifies the terminal block associated with the electronic module.

For further generic descriptions, refer to I/O Configuration Tab Description ([see page 26](#)).

I/O Mapping Tab

Variables can be defined and named in the **I/O Configuration** tab. Additional information such as topological addressing is also provided in this tab.

This table describes the I/O Mapping:

Variable	Channel	Type	Description
Inputs	DigitalInputs	USINT	State of all inputs
	DigitalInput00	BOOL	State of input 0

	DigitalInput05 *		State of input 5
PowerSupply	BOOL	Status bit associated to external power supply: <ul style="list-style-type: none"> ● 0: no AC external power supply or < 85 Vac ● 1: AC external power supply OK 	

* The number of DigitalInput bit is equal to the module input number.

For further generic descriptions, refer to I/O Mapping Tab Description ([see page 26](#)).

Cycle Time and I/O Update Time

This table gives the module characteristics allowing the TM5 Bus Cycle Time configuration:

Characteristic	Value (µs)	
	Without filter	With filter
Minimum cycle time	100	150
Minimum I/O update time	100	200

For further information, refer to TM5 Manager Configuration ([see page 23](#)).

TM5SDI12D

Introduction

The TM5SDI12D expansion electronic module is a 24 Vdc Digital Inputs electronic module with 12 inputs.

For further information, refer to TM5SDI12D Electronic Module 12DI 24 Vdc Sink 1 Wire (see *Modicon TM5, Digital I/O Modules, Hardware Guide*).

I/O Configuration Tab

To configure the TM5SDI12D electronic module, select the **I/O Configuration** tab.

This table describes the modules parameters configuration:

Parameter	Value	Default Value	Unit	Description
Module address	0...250	Depends on the configuration	-	The address is automatically set when adding the modules. The address value depends on the order of adding the module in the SoMachine tree. The TM5ACBM15 supports the possibility to change the address.
Input filter	0...250	10 (1 ms)	0.1 ms	Specifies the filter time of all digital inputs in the range 0...250 (0...25 ms).
Bus base	TM5ACBM15 TM5ACBM11	TM5ACBM11	-	Specifies the bus base associated with the electronic module.
Terminal block	TM5ACTB12	TM5ACTB12	-	Specifies the terminal block associated with the electronic module.

Parameter	Value	Default Value	Unit	Description
24 V I/O segment external current	0...500	100 mA	-	Current derived from the 24 Vdc I/O power segment to supply the sensors connected to the module. This value is used to balance current consumption on the 24Vdc I/O power segment (see <i>Modicon TM5 / TM7 Flexible System, System Planning and Installation Guide</i>). This value is used exclusively in the calculation of the Check Resources function.

For further generic descriptions, refer to I/O Configuration Tab Description (see page 26).

I/O Mapping Tab

Variables can be defined and named in the **I/O Mapping** tab. Additional information such as topological addressing is also provided in this tab.

This table describes the I/O Mapping:

Variable	Channel	Type	Description
Inputs	DigitallInputs	USINT	State of all inputs
	DigitallInput00	BOOL	State of input 0

	DigitallInput11		State of input 11

For further generic descriptions, refer to I/O Mapping Tab Description (see page 26).

Cycle Time and I/O Update Time

This table gives the module characteristics allowing the TM5 Bus Cycle Time configuration:

Characteristic	Value (µs)	
	Without filter	With filter
Minimum cycle time	100	150
Minimum I/O update time	100	200

For further information, refer to TM5 Manager Configuration (see page 23).

TM5SDI16D

Introduction

The TM5SDI16D expansion electronic module is a 24 Vdc Digital Inputs electronic module with 16 inputs.

For further information, refer to TM5SDI16D Electronic Module 16DI 24 Vdc Sink 1 Wire (see *Modicon TM5, Digital I/O Modules, Hardware Guide*).

I/O Configuration Tab

To configure the TM5SDI16D electronic module, select the **I/O Configuration** tab.

This table describes the modules parameters configuration:

Parameter	Value	Default Value	Unit	Description
Module address	0...250	Depends on the configuration	-	The address is automatically set when adding the modules. The address value depends on the order of adding the module in the SoMachine tree.
Input filter	0...250	10 (1 ms)	0.1 ms	Specifies the filter time of all digital inputs in the range 0...250 (0...25 ms).
Bus base	TM5ACBM11 TM5ACBM15	TM5ACBM11	-	Specifies the bus base associated with the electronic module.
Terminal block	TM5ACTB16	TM5ACTB16	-	Specifies the terminal block associated with the electronic module.

For further generic descriptions, refer to I/O Configuration Tab Description (see [page 26](#)).

I/O Mapping Tab

Variables can be defined and named in the **I/O Mapping** tab. Additional information such as topological addressing is also provided in this tab.

This table describes the I/O Mapping:

Variable	Channel	Type	Description
Inputs	DigitalInputs	USINT	State of all inputs
	DigitalInput00	BOOL	State of input 0

	DigitalInput15		State of input 15

For further generic descriptions, refer to I/O Mapping Tab Description ([see page 26](#)).

Cycle Time and I/O Update Time

This table gives the module characteristics allowing the TM5 Bus Cycle Time configuration:

Characteristic	Value (µs)	
	Without filter	With filter
Minimum cycle time	100	150
Minimum I/O update time	100	200

For further information, refer to TM5 Manager Configuration ([see page 23](#)).

TM5SDI2DF

Introduction

The TM5SDI2DF expansion electronic module is a 24 Vdc input electronic module with 2 fast inputs.

For further information, refer to TM5SDI2DF Electronic Module 2DI 24 Vdc Sink 3-Wire.

I/O Configuration Tab

To configure the TM5SDI2DF electronic module, select the **I/O Configuration** tab.

This table describes the module parameters configuration:

Parameter		Value	Default Value	Unit	Description
Function model		Default Additional function input latch	Default	-	Additional function input latch: the Status00...Status03 are added to the I/O Mapping tab.
General	Module Address	0...250	0	-	Address of the module on the expansion bus TM5.
	Input filter	0...250	10	0.1 ms	Specifies the filter time of all digital inputs in the range 0...250 (0...25 ms).
	Bus Base	TM5ACBM11 TM5ACBM15	TM5ACBM11	-	Specifies the bus base associated with the electronic module.
	Terminal Block	TM5ACTB06 TM5ACTB12	TM5ACTB06	-	Specifies the terminal block associated with the electronic module.
	24V I/O segment external current	0...500	100 mA	-	Adjusts the Power Current to supply the sensors connected to the module.
Counter00 Counter01	Counter mode	Event counter Gate measurement	Event counter	-	Counter mode (see page 86)
	Clock frequency	48	48	Mhz	Specifies the frequency of the internal clock.

For further generic descriptions, refer to I/O Configuration Tab Description ([see page 26](#)).

I/O Mapping Tab

Variables can be defined and named in the **I/O Mapping** tab. Additional information such as topological addressing is also provided in this tab.

This table describes the I/O Mapping:

Variable	Channel	Type	Description
Inputs	DigitalInputs	USINT	State of all inputs
		BOOL	State of input 0
		BOOL	State of input 1
	Counter00	UINT	Event counter or gate measurement
	Counter01	UINT	Event counter or gate measurement

For further generic descriptions, refer to I/O Mapping Tab Description ([see page 26](#)).

Counter Mode

2 counter modes can be used with the TM5SDI2DF electronic module:

- Event counter operation - consists of transferring the counter status, registered with a fixed offset with respect to the bus cycle, and is transferred in the same cycle.

NOTE: The rising edges are registered on the counter input.

- Gate measurement - consists of using an internal frequency to register the necessary time to reach the gate input.

The following figure describes the gate measuring principle:

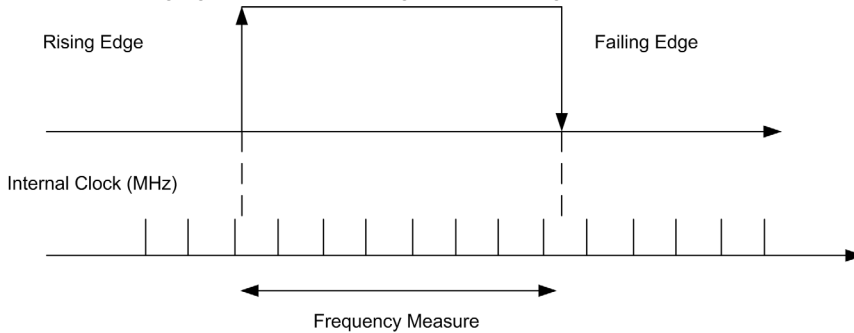

The TM5SDI2DF value is defined by the following equation:

$$SP = \frac{VT}{CF}$$

Where:

SP = Size of Pulse to be measured.

VT = Value of TM5SDI2DF.

CF = Clock Frequency.

For example: For a Clock Frequency at 3 Mhz and a Size of Pulse to be measured = 15 ms, the value of TM5SDI2DF is near 46000.

NOTE:

- Only one of the counter channels can be used for gate measurement at any one time.
- The time between rising and falling edges for the gate input is registered using an internal frequency. The result is verified for overflow (FFFF hex).
- The recovery time between measurements must be > 100 μs.
- The measurement result is transferred with the falling edge to the result memory.

The following table gives the maximum Size of Pulse to be measured depending on the Count Frequency parameter:

Maximum Size of Pulse	Clock Frequency
13.653125 ms	48 MHz
27.30625 ms	24 MHz
54.6125 ms	12 MHz
109.225 ms	6 MHz
218.45 ms	3 MHz
436.9 ms	1.5 MHz
873.8 ms	0.75 MHz
1747.6 ms	0.375 MHz
3542.432432 ms	0.185 MHz

For example: For a Clock Frequency at 48 Mhz, the maximum Size of Pulse to be measured = 13 ms.

Additional Function Input Latch

Using this function, the positive edges of the input signal can be latched with a resolution of 200 μ s. With the “Acknowledge - input latch” function, the input latch is either reset or prevented from latching.

It works in the same way as a dominant reset RS flip-flop:

R: Status03	S: Status02	Q	Status
0	0	x	Do not change
0	1	1	Set
1	0	0	Reset
1	1	0	Reset

I/O Mapping Tab

Variables can be defined and named in the **I/O Mapping** tab. Additional information such as topological addressing is also provided in this tab.

This table describes the **I/O Mapping**:

Channel	Channel	Type	Default Value	Description
Inputs	DigitallInput	USINT	-	State of digital inputs (bits 2...7: not used)
	DigitalInput00	BOOL	-	State of digital input 0
	DigitalInput01	BOOL	-	State of digital input 1
	Counter00	UINT	-	Counter 0 value
	Counter01	UINT	-	Counter 1 value
	Status02	USINT	-	
	DigitalInput00Latch	BOOL	-	Positive edge latched state of input 0
	DigitalInput01Latch			Positive edge latched state of input 1

Channel	Channel	Type	Default Value	Description
Outputs	Status00	USINT	-	
	Not used	BOOL	-	Not used
	...			
	Not used			
	ResetCounter00			
	Status01	USINT	-	
	Not used	BOOL	-	Not used
	...			
	Not used			
	ResetCounter01			
	Status03	USINT	-	
	DigitalInput00LatchQuitt	BOOL	-	Acknowledge latch state input 0
	DigitalInput01LatchQuitt			Acknowledge latch state input 1

For further generic descriptions, refer to I/O Mapping Tab Description ([see page 26](#)).

Cycle Time and I/O Update Time

This table gives the module characteristics allowing the TM5 Bus Cycle Time configuration:

Characteristic	Value
Minimum cycle time	100 µs
Minimum I/O update time	100 µs

For further information, refer to TM5 Manager Configuration ([see page 23](#)).

TM5SDO2T, TM5SDO4T, TM5SDO6T, TM5SDO12T, and TM5SDO16T

Introduction

The TM5SDO2T, TM5SDO4T, TM5SDO6T, TM5SDO12T and TM5SDO16T expansion electronic modules are 24 Vdc Digital Outputs electronic modules with 2, 4, 6, 12 or 16 outputs respectively.

For further information, refer to the Hardware Guide:

Reference	Refer to
TM5SDO2T	TM5SDO2T Electronic Module 2DO 24 Vdc Tr 0.5 A 3 Wires (see <i>Modicon TM5, Digital I/O Modules, Hardware Guide</i>)
TM5SDO4T	TM5SDO4T Electronic Module 4DO 24 Vdc Tr 0.5 A 3 wires (see <i>Modicon TM5, Digital I/O Modules, Hardware Guide</i>)
TM5SDO6T	TM5SDO6T Electronic Module 6DO 24 Vdc Tr 0.5 A 2 wires (see <i>Modicon TM5, Digital I/O Modules, Hardware Guide</i>)
TM5SDO12T	TM5SDO12T Electronic Module 12DO 24 Vdc Tr 0.5 A 1 wire (see <i>Modicon TM5, Digital I/O Modules, Hardware Guide</i>)
TM5SDO16T	TM5SDO16T Electronic Module 16DO 24 Vdc Tr 0.5 A 1 wire (see <i>Modicon TM5, Digital I/O Modules, Hardware Guide</i>)

I/O Configuration Tab

To configure the TM5SDO2T, TM5SDO4T, TM5SDO6T, TM5SDO12T and TM5SDO16T electronic modules, select the **I/O Configuration** tab.

This table describes the modules parameters configuration:

Parameter	Value	Default Value	Description
Module address	0...250	Depends on the configuration	The address is automatically set when adding the modules. The address value depends on the order of adding the module in the SoMachine tree. The TM5ACBM15 supports the possibility to change the address.
Output status information	On Off	On	Enable/Disable the read of the output status. On: the StatusDigitalOutputs word is added to the I/O Mapping tab.
Bus base	TM5ACBM15 TM5ACBM11	TM5ACBM11	Specifies the bus base associated with the electronic module.
Terminal block*	TM5ACTB06 TM5ACTB12 TM5ACTB16	TM5ACTB06 TM5ACTB12 TM5ACTB16	Specifies the terminal block associated with the electronic module.
24 V I/O segment external current	0...1500	700 mA	Current derived from the 24 Vdc I/O power segment to supply the sensors connected to the module. This value is used to balance current consumption on the 24Vdc I/O power segment (<i>see Modicon TM5 / TM7 Flexible System, System Planning and Installation Guide</i>). This value is used exclusively in the calculation of the Check Resources function.

* Terminal block values and default values depend on the module reference.

For further generic descriptions, refer to I/O Configuration Tab Description ([see page 26](#)).

I/O Mapping Tab

Variables can be defined and named in the **I/O Mapping** tab. Additional information such as topological addressing is also provided in this tab.

This table describes the I/O Mapping:

Variable	Channel	Type	Default value	Description
Inputs	StatusDigitalOutputs	USINT	-	Status word of all outputs
	StatusDigitalOutput00	BOOL	-	Status bit associated to each output: ● 0: OK ● 1: error detected
	...			
	StatusDigitalOutput15 *			
Outputs	DigitalOuputs	USINT	-	Command word of all outputs
	DigitalOuput00	BOOL	None TRUE FALSE	Command bit of output 0

	DigitalOuput15 *			Command bit of output 15

* The number of DigitalOuput bit is equal to the module output number.

For further generic descriptions, refer to I/O Mapping Tab Description ([see page 26](#)).

Cycle Time and I/O Update Time

This table gives the module characteristics allowing the TM5 Bus Cycle Time configuration:

Characteristic	Value (µs)
Minimum cycle time	100
Minimum I/O update time	100

For further information, refer to TM5 Manager Configuration ([see page 23](#)).

TM5SDO4TA and TM5SDO8TA

Introduction

The TM5SDO4TA and TM5SDO8TA expansion electronic modules are 24 Vdc Digital Output electronic modules with 4 and 8 outputs respectively.

For further information, refer to the Hardware Guide:

Reference	Refer to
TM5SDO4TA	TM5SDO4TA Electronic Module 4DO 24 Vdc Tr 2 A 3 Wires (see <i>Modicon TM5, Digital I/O Modules, Hardware Guide</i>)
TM5SDO8TA	TM5SDO8TA Electronic Module 8DO 24 Vdc Tr 2 A 1 Wire (see <i>Modicon TM5, Digital I/O Modules, Hardware Guide</i>)

I/O Configuration Tab

To configure the TM5SDO4TA and TM5SDO8TA electronic modules, select the **I/O Configuration** tab.

This table describes the modules parameters configuration:

Parameter	Value	Default Value	Description
Module address	0...250	Depends on the configuration	The address is automatically set when adding the modules. The address value depends on the order of adding the module in the SoMachine tree. The TM5ACBM15 supports the possibility to change the address.
Output status information	On Off	On	Enable/Disable the read of the output status. On: the StatusDigitalOutputs word is added to the I/O Mapping tab
Bus base	TM5ACBM15 TM5ACBM11	TM5ACBM11	Specifies the bus base associated with the electronic module.
Terminal block	TM5ACTB12	TM5ACTB12	Specifies the terminal block associated with the electronic module.
Power supply (Only for TM5SDO8TA)	On Off	Off	Enable/Disable the read of the power supply status.
24 V I/O segment external current (Only for TM5SDO4TA)	0...4500	2200 mA	Current derived from the 24 Vdc I/O power segment to supply the sensors connected to the module. This value is used to balance current consumption on the 24Vdc I/O power segment (see <i>Modicon TM5 / TM7 Flexible System, System Planning and Installation Guide</i>). This value is used exclusively in the calculation of the Check Resources function.

For further generic descriptions, refer to I/O Configuration Tab Description ([see page 26](#)).

I/O Mapping Tab

Variables can be defined and named in the **I/O Mapping** tab. Additional information such as topological addressing is also provided in this tab.

This table describes the I/O Mapping:

Variable	Channel	Type	Default Value	Description
Inputs	StatusDigitalOutputs	USINT	-	Status word of all outputs
	StatusDigitalOutput00	BOOL	-	Status bit associated to each output: <ul style="list-style-type: none"> ● 0: OK ● 1:error detected
	...			
StatusDigitalOutput07 *				
Outputs	DigitalOuputs	USINT	-	Command word of all outputs
	DigitalOuput00	BOOL	None TRUE FALSE	Command bit of output 0

	DigitalOuput07 *			Command bit of output 7

* The number of DigitalOuput bit is equal to the module output number.

For further generic descriptions, refer to I/O Mapping Tab Description ([see page 26](#)).

Cycle Time and I/O Update Time

This table gives the module characteristics allowing the TM5 Bus Cycle Time configuration:

Characteristic	Value (µs)
Minimum cycle time	100
Minimum I/O update time	100

For further information, refer to TM5 Manager Configuration ([see page 23](#)).

TM5SDO2R and TM5SDO4R

Introduction

The TM5SDO2R and TM5SDO4R expansion electronic modules are 30 Vdc Digital Outputs electronic modules with 2 and 4 outputs respectively.

For further information, refer to the Hardware Guide:

Reference	Refer to
TM5SDO2R	TM5SDO2R Electronic Module 2DO 30 Vdc/230 Vac 5A Relay C/O (see <i>Modicon TM5, Digital I/O Modules, Hardware Guide</i>)
TM5SDO4R	TM5SDO4R Electronic Module 4DO 30 Vdc / 230 Vac 5 A Relay N/O (see <i>Modicon TM5, Digital I/O Modules, Hardware Guide</i>)

I/O Configuration Tab

To configure the TM5SDO2R and TM5SDO4R electronic modules, select the **I/O Configuration** tab.

This table describes the modules parameters configuration:

Parameter	Value	Default Value	Description
Module address	0...250	Depends on the configuration	The address is automatically set when adding the modules. The address value depends on the order of adding the module in the SoMachine tree. The TM5ACBM15 supports the possibility to change the address.
Bus base	TM5ACBM15 TM5ACBM11	TM5ACBM11	Specifies the bus base associated with the electronic module.
Terminal block	TM5ACTB12	TM5ACTB12	Specifies the terminal block associated with the electronic module.

For further generic descriptions, refer to I/O Configuration Tab Description ([see page 26](#)).

I/O Mapping Tab

Variables can be defined and named in the **I/O Mapping** tab. Additional information such as topological addressing is also provided in this tab.

This table describes the I/O Mapping:

Variable	Channel	Type	Default Value	Description
Outputs	DigitalOutputs	USINT	-	Command word of all outputs
	DigitalOutput00	BOOL	None	Command bit of output 0
	...		TRUE	...
	DigitalOutput07 *		FALSE	Command bit of output 7

* The number of DigitalOutput bit is equal to the module output number.

For further generic descriptions, refer to I/O Mapping Tab Description ([see page 26](#)).

Cycle Time and I/O Update Time

This table gives the module characteristics allowing the TM5 Bus Cycle Time configuration:

Characteristic	Value (µs)
Minimum cycle time	100
Minimum I/O update time	100

For further information, refer to TM5 Manager Configuration ([see page 23](#)).

TM5SDO2S

Introduction

The TM5SDO2S expansion electronic module is a 240 Vac Digital Outputs electronic module with 2 outputs.

For further information, refer to TM5SDO2S Electronic Module 2DO 240 Vac 1 A 3 wires (see *Modicon TM5, Digital I/O Modules, Hardware Guide*).

I/O Configuration Tab

To configure the TM5SDO2S electronic module, select the **I/O Configuration** tab.

This table describes the modules parameters configuration:

Parameter	Value	Default Value	Description
Module address	0...250	Depends on the configuration	The address is automatically set when adding the modules. The address value depends on the order of adding the module in the SoMachine tree.
Bus base	TM5ACBM12	TM5ACBM12	Specifies the bus base associated with the electronic module.
Terminal block	TM5ACTB32	TM5ACTB32	Specifies the terminal block associated with the electronic module.

For further generic descriptions, refer to I/O Configuration Tab Description ([see page 26](#)).

I/O Mapping Tab

Variables can be defined and named in the **I/O Mapping** tab. Additional information such as topological addressing is also provided in this tab.

This table describes the I/O Mapping:

Variable	Channel	Type	Default value	Description
Outputs	DigitalOuputs	USINT	–	Command word of all outputs
	DigitalOuput00	BOOL	None TRUE FALSE	Command bit of output 0
	DigitalOuput01			Command bit of output 1

For further generic descriptions, refer to I/O Mapping Tab Description ([see page 26](#)).

Cycle Time and I/O Update Time

This table gives the module characteristics allowing the TM5 Bus Cycle Time configuration:

Characteristic	Value (μs)
Minimum cycle time	100
Minimum I/O update time	100

For further information, refer to TM5 Manager Configuration ([see page 23](#)).

TM5SDM12DT

Introduction

The TM5SDM12DT expansion electronic module is a 24 Vdc Digital Inputs electronic module with 8 inputs and 4 outputs.

For further information, refer to TM5SDM12DT Electronic Module 8DI/4DO Tr 1 Wire (see *Modicon TM5, Digital I/O Modules, Hardware Guide*).

I/O Configuration Tab

To configure the TM5SDM12DT electronic module, select the **I/O configuration** tab.

This table describes the modules parameters configuration:

Parameter	Value	Default Value	Unit	Description
Module address	0...250	Depends on the configuration	-	The address is automatically set when adding the modules. The address value depends on the order of adding the module in the SoMachine tree. The TM5ACBM15 supports the possibility to change the address.
Input filter	0...250	10 (1 ms)	0.1 ms	Specifies the filter time of all digital inputs in the range 0...250 (0...25 ms).
Output status information	On Off	On	-	Enable/Disable the read of the output status. On: the StatusDigitalOutputs word is added to the I/O Mapping tab.
Bus base	TM5ACBM11 TM5ACBM15	TM5ACBM11	-	Specifies the bus base associated with the electronic module.
Terminal block	TM5ACTB12	TM5ACTB12	-	Specifies the terminal block associated with the electronic module.

For further generic descriptions, refer to I/O Configuration Tab Description (see page 26).

I/O Mapping Tab

Variables can be defined and named in the **I/O Mapping** tab. Additional information such as topological addressing is also provided in this tab.

This table describes the I/O Mapping:

Variable	Channel	Type	Default Value	Description
Inputs	DigitalInputs	USINT	-	State of all inputs
	DigitalInput00	BOOL	-	State of input 0
	...			
	DigitalInput07			State of input 7
	StatusDigitalOutputs	USINT	-	Status word of all outputs (bits 4...7: not used)
	StatusDigitalOutput00	BOOL	-	Status bit associated to each output: <ul style="list-style-type: none"> ● 0: OK ● 1: error detected
...				
StatusDigitalOutput03				
Outputs	DigitalOuputs	USINT	-	Command word of all outputs (bits 4...7: not used)
	DigitalOuput00	BOOL	None TRUE FALSE	Command bit of output 0

	DigitalOuput03			Command bit of output 3

For further generic descriptions, refer to I/O Mapping Tab Description ([see page 26](#)).

Cycle Time and I/O Update Time

This table gives the module characteristics allowing the TM5 Bus Cycle Time configuration:

Characteristic	Value (µs)	
	Without filter	With filter
Minimum cycle time	100	150
Minimum I/O update time	100	200

For further information, refer to TM5 Manager Configuration ([see page 23](#)).

TM5SMM6D2L

Introduction

The TM5SMM6D2L expansion electronic modules is a mixed module with 4 digital inputs, 2 digital outputs, 1 analog input, and 1 analog output.

If you have wired your input for a voltage measurement, and you configure SoMachine for a current type of configuration, you may permanently damage the electronic module.

NOTICE

INOPERABLE EQUIPMENT

Verify that the physical wiring of the analog circuit is compatible with the software configuration for the analog channel.

Failure to follow these instructions can result in equipment damage.

For further information, refer to TM5SMM6D2L Electronic Module 4DI/2DO 24Vdc Tr 0.5A / 1AI/1AO $\pm 10V/0-20mA$ 12 Bits 1 Wire (see *Modicon TM5, Digital I/O Modules, Hardware Guide*).

I/O Configuration Tab

To configure the TM5SMM6D2L electronic module, select the **I/O Configuration** tab.

This table describes the modules parameters configuration:

Parameter		Value	Default Value	Description
General	Module address	0...250	0	The address is automatically set when adding the modules. The address value depends on the order of adding the module in the SoMachine tree. The TM5ACBM15 supports the possibility to change the address.
	Bus base	TM5ACBM11 TM5ACBM15	TM5ACBM11	Specifies the bus base associated with the electronic module.
	Terminal block	TM5ACTB12	TM5ACTB12	Specifies the terminal block associated with the electronic module.
Digital Inputs	Input filter	0...250	10	Specifies the filter time of all digital inputs in the range 0...250 (0...25 ms).
	Input latch	on off	off	This parameter allows to activate (when value is on) or deactivate (when value is off) the input latch.

Parameter		Value	Default Value	Description
Analog Inputs	Lower limit (Minimum value)	-32768...32767	-32768	Specifies the lower measurement limit (see page 103).
	Upper limit (Maximum value)	-32768...32767	32767	Specifies the upper measurement limit (see page 103).
	Channel type	±10 V 0 to 20 mA 4 to 20 mA	±10 V	Specifies the channel type.
	Input filter	off level 2 level 4 level 8 level 16 level 32 level 64 level 128	off	Definition of the filter level (see page 105).
	Input limitation	off 16383 8191 4095 2047 1023 511 255	off	Specifies the limitation of input ramp (see page 107). NOTE: Parameter available if an input filter is selected.
Digital Outputs	Output status information	on off	on	Enable/Disable the read of the output status. on: The StatusDigitalOutputs word is added to the I/O Mapping tab.
Analog Outputs	Channel type	±10 V 0 to 20 mA	±10 V	Specifies the channel type.

For further generic descriptions, refer to I/O Configuration Tab Description ([see page 26](#)).

Analog Inputs

The input status is registered with a fixed offset with respect to the network cycle and is transferred in the same cycle.

Input Cycle

The electronic module is equipped with a configurable Input cycle. Filtering is deactivated for shorter cycle times.

If the Input cycle is active, then the channels are scanned in millisecond cycles. The time offset between the channels is 200 μ s. The conversion takes place asynchronously to the network cycle. Refer to Cycle time and I/O update time ([see page 110](#))

Limit Values

You can define 2 different types of limits:

- **Lower limit**
- **Upper limit**

The **Lower limit** value range is between -32768 and 32767. This value is applied on every channel of the module being configured.

NOTE: the **Lower limit** cannot be greater than the **Upper limit**.

Channel Configuration	Digital Value Behavior	Comments
± 10 V	-10 V = -32768 +10 V = +32767	If the Lower limit value is configured between -32768 and +32767, the digital value is limited to the Lower limit value.
0...20 mA	0 mA = 0 20 mA = +32767	If the Lower limit value is configured between -32768 and 0, the digital value is limited to 0. If the Lower limit value is configured between 0 and 32767, the digital value is limited to the Lower limit value.
4...20 mA	0 mA = -8192 4 mA = 0 20 mA = +32767	If the Lower limit is configured between -32768 and -8192, the digital value is limited to -8192. If the Lower limit is configured between -8192 and 32767, the digital value is limited to the Lower limit value.

The **Upper limit** value range is between -32768 and 32767. This value is applied on every channel of the module being configured.

NOTE: The **Upper limit** value cannot be less than the **Lower limit** value.

Channel Configuration	Digital Value Behavior	Comments
± 10 V	-10 V = -32768 +10 V = +32767	If the Upper limit value is configured between -32768 and +32767, the digital value is limited to the Upper limit value.
0...20 mA	0 mA = 0 20 mA = +32767	If the Upper limit value is configured between -32768 and 0, the digital value stays at 0; hence, set the Upper limit value to a positive value. If the Upper limit value is configured between 1 and +32767, the digital value is limited to the Upper limit value.
4...20 mA	0 mA = -8192 4 mA = 0 20 mA = +32767	If the Upper limit value is configured between -32768 and -8192, the digital value is limited to -8192. If the Upper limit value is configured between -8192 and 32767, the digital value is limited to the Upper limit value.

Filter Level

The input value is evaluated according to the filter level. An input ramp limitation can then be applied using this evaluation.

Formula for the evaluation of the input value:

$$Value_{new} = Value_{old} - \frac{Value_{old}}{Filterlevel} + \frac{Inputvalue}{Filterlevel}$$

The following examples show the function of the input ramp limitation based on an input jump and a disturbance.

Example 1: The input value makes a jump from 8000 to 16000. The diagram displays the evaluated value with the following settings:

Input ramp limitation = 0

Filter level = 2 or 4

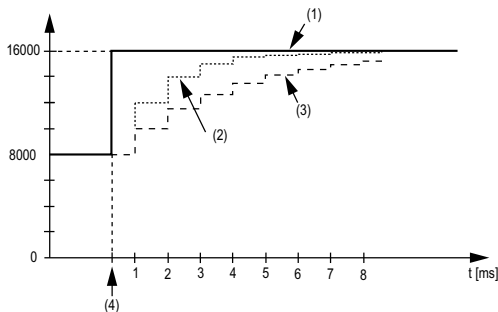

- 1 Input value.
- 2 Evaluated value: Filter level 2
- 3 Evaluated value: Filter level 4
- 4 Input jump

Example 2: A disturbance is imposed on the input value. The diagram shows the evaluated value with the following settings:

Input ramp limitation = 0

Filter level = 2 or 4

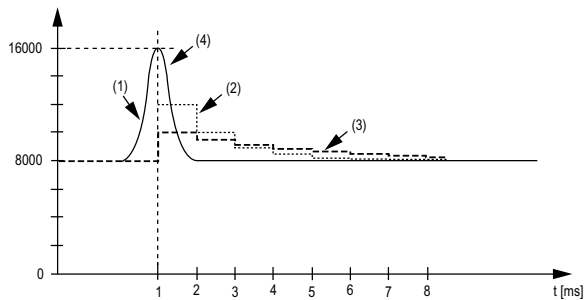

- 1 Input value
- 2 Evaluated value: Filter level 2
- 3 Evaluated value: Filter level 4
- 4 Disturbance (Spike)

Input Ramp Limitation

Input ramp limitation can only take place when a filter is used. Input ramp limitation is executed before filtering takes place.

The change in the input value is verified to make sure that the specified limits are not exceeded. If the values are exceeded, the adjusted input value is equal to the old value \pm the limit value.

The input ramp limitation is well suited for suppressing disturbances (spikes). The following examples show the function of the input ramp limitation based on an input jump and a disturbance.

Example 1: The input value makes a jump from 8,000 to 17,000. The diagram displays the adjusted input value for the following settings:

Input ramp limitation = 2047

Filter level = 2

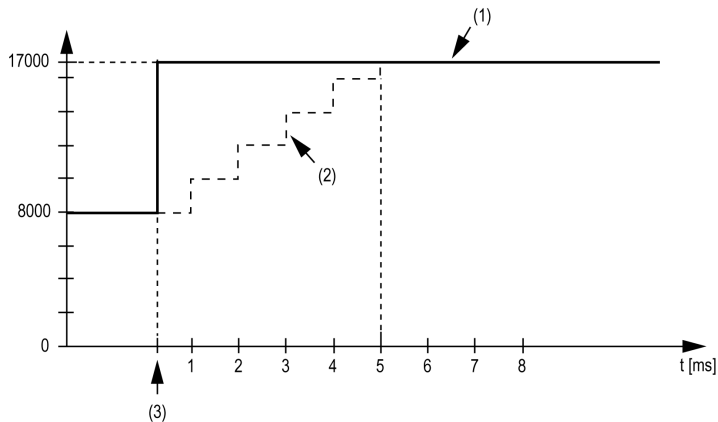

- 1 Input value
- 2 Internal adjusted input value before filter
- 3 Input jump

Example 2: A disturbance is imposed on the input value. The diagram shows the adjusted input value with the following settings:

Input ramp limitation = 2047

Filter level = 2

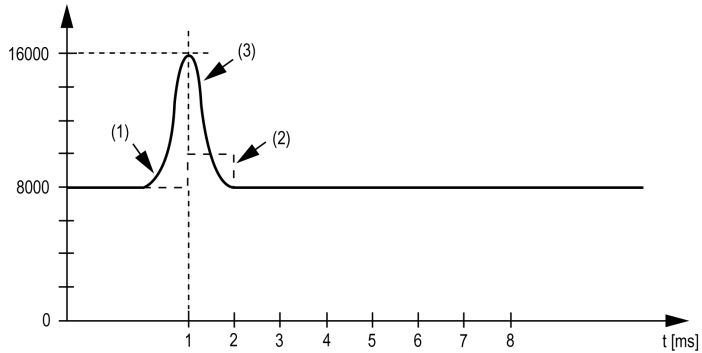

- 1 Input value
- 2 Internal adjusted input value before filter
- 3 Disturbance (Spike)

I/O Mapping Tab

Variables can be defined and named in the **I/O Mapping** tab. Additional information such as topological addressing is also provided in this tab.

This table describes the I/O Mapping:

Variable	Channel	Type	Value	Description
Inputs	Digital Inputs	USINT	-	State of all inputs.
	DigitalInput00	BOOL	-	State of input 0.

	DigitalInput03	BOOL		State of input 3.
	StatusDigitalOutput00	BOOL		Status bit associated to each output: <ul style="list-style-type: none"> ● 0: OK ● 1: error detected
	StatusDigitalOutput01	BOOL		
	AnalogInput00	INT	-	Current value of the input 0.
	DigitalInputLatch	BOOL		
	DigitalInput00Latch	BOOL		
	...			
	DigitalInput03Latch	BOOL		
	StatusInput00	USINT	-	Status of analog input channel (see description in the Status Input Register section of this chapter (see page 110)).
	Outputs	DigitalOutputs	USINT	-
DigitalOutput00		BOOL	None TRUE FALSE	Command bit of output 0.
DigitalOutput01				Command bit of output 1.
AnalogOutput00		INT	-	Command word of the output 0.
DigitalInputLatchQuit		BOOL		
DigitalInput00LatchQuit		BOOL		
...				
DigitalInput03LatchQuit		BOOL		

NOTE: The **DigitalInputLatch** and the **DigitalInputLatchQuit** are available, only if the **nputLatchI** parameter is set to **on** in the **I/O configuration** tab.

For further generic descriptions, refer to I/O Mapping Tab Description ([see page 26](#)).

Status Input Register

The **StatusInput00** byte describes the status of the analog input channel:

Bit	Description	Bits value
0-1	Channel 00 status	00: No error detected 01: Below lower limit value ¹ 10: Above upper limit value 11: Wire break
¹ Current signal 0...20 mA <u>Default setting:</u> The input value has a lower limit. Underflow monitoring is, therefore, not necessary. <u>After lower limit value changes:</u> The input value is limited to the set value. The status bit is set when the lower limit value is passed.		

Cycle Time and I/O Update Time

This table gives the module characteristics allowing the TM5 Bus Cycle Time configuration:

Characteristic	Value (µs)					
	Without filter on analog input channels	With filter on analog input channels	Without filter on digital input channels	With filter on digital input channels	On analog output channel	On digital output channels
Minimum cycle time	100	500	100	150	250	100
Minimum I/O update time	300	1000	100	200	< 300	100

For further information, refer to TM5 Manager Configuration ([see page 23](#)).

Chapter 4

TM5 Analog I/O Electronic Modules

Introduction

This chapter provides information to configure analog I/O expansion electronic modules.

To add expansion electronic modules and access to the configuration screens, refer to Adding an expansion electronic module ([see page 26](#)).

What Is in This Chapter?

This chapter contains the following topics:

Topic	Page
TM5SAI2H and TM5SAI4H	112
TM5SAI2L and TM5SAI4L	120
TM5SAI2PH and TM5SAI4PH	129
TM5SAI2TH and TM5SAI6TH	134
TM5SAO2H and TM5SAO2L	141
TM5SAO4H and TM5SAO4L	144

TM5SAI2H and TM5SAI4H

Introduction

The TM5SAI2H and TM5SAI4H expansion electronic modules are 10 Vdc Analog Input electronic modules with 2 and 4 inputs respectively.

If you have wired your input for a voltage measurement and you configure SoMachine for a current type of configuration, you may permanently damage the electronic module.

NOTICE

INOPERABLE EQUIPMENT

Verify that the physical wiring of the analog circuit is compatible with the software configuration for the analog channel.

Failure to follow these instructions can result in equipment damage.

For further information, refer to the Hardware Guide:

Reference	Refer to
TM5SAI2H	TM5SAI2H Electronic Module 2AI $\pm 10V/0-20mA$ 16 Bits (see <i>Modicon TM5, Analog I/O Modules, Hardware Guide</i>)
TM5SAI4H	TM5SAI4H Electronic Module 4AI $\pm 10V/0-20mA$ 16 Bits (see <i>Modicon TM5, Analog I/O Modules, Hardware Guide</i>)

I/O Configuration Tab

To configure the TM5SAI2H and TM5SAI4H electronic modules, select the **I/O Configuration** tab.

This table describes the modules parameters configuration:

Parameter	Parameter	Value	Default Value	Description
General	Module address	0...250	Depends on the configuration	The address is automatically set when adding the modules. The address value depends on the order of adding the module in the SoMachine tree. The TM5ACBM15 support the possibility to change the address.
	Sample time	50...10000	100 μ s	Time during which all inputs are updated.
	Channel status information	On Off	On	Enable/Disable the read of the channel status information On: the Status00 word is added to the I/O Mapping tab.
	Extended channel status information	On Off	Off	Enable/Disable the read of the extended channel status information On: the Status01 and Status02 words are added to the I/O Mapping tab.
	Bus base	TM5ACBM11 TM5ACBM15	TM5ACBM11	Specifies the bus base associated with the electronic module.
	Terminal block	TM5ACTB06 (only for TM5SAI2H) TM5ACTB12	TM5ACTB06 (for TM5SAI2H) TM5ACTB12 (for TM5SAI4H)	Specifies the terminal block associated with the electronic module.

Parameter	Parameter	Value	Default Value	Description
Channel 00	Channel on/off	On Off	On	Enable/disable the channel. Off: All the channel bit associated to the input 0 are removed in the I/O Mapping tab.
	Minimum value	-32768...32767	-32768	Limitation minimum value (see page 114)
	Maximum value	-32768...32767	32767	Limitation maximum value (see page 114)
	Gain	-2147483648... 2147483647	65536	Refer to Scaling (see page 115). 1.0 corresponds with 10000 hex.
	Offset	-2147483648... 2147483647	0	
	Channel type	±10 V 0...20 mA	±10 V	Specifies the channel type.
	Error check	On Off	On	Detects a possible error on the system.
	Minimum/ maximum value check	Off Positive Negative Positive/ Negative	Off	Activate minimum and maximum input values (see page 115). Other than Off : the Status03 and Status04 words are added to the I/O Mapping tab.
	Filter	On Off	Off	Enable/disable the input filter.
	Filter order	1...4	1	Refer to Input Cycle (see page 116).
	Filter cut off frequency	1...65535	500 Hz	NOTE: Parameter only available if Filter is selected.

For further generic descriptions, refer to I/O Configuration Tab Description ([see page 26](#)).

The same Channel00 parameters are also available for:

- Channel01 (for the TM5SAI2H)
- Channel01...03 (for the TM5SAI4H)

Limit Values

The user can specify an upper and lower limit value for each individual channel.

When activated, the input signals are monitored to see if the limit values are exceeded. The defined limit values are used for this. If the analog value goes beyond the defined range, then it is limited to the upper or lower limit value.

The result of the signal check is displayed in a corresponding status bit. If necessary, the counters are incremented by one if the value falls outside the range.

Scaling

The raw A/D converter data and the filtered A/D converter data are compared. The system measure and the user measure are grouped internally as a k/d pair to optimize the execution time. Gain and offset can be specified for each individual channel.

Minimum and Maximum Input Values

The system stores the minimum and maximum values between two trigger events. The function is started by the corresponding trigger edge. The following edges are evaluated depending on the configuration:

- Positive edge
- Negative edge
- Positive and negative edge

The trigger counter counts valid trigger events. In the event that trigger events occur faster than the sampling cycle, the triggering becomes invalid (trigger detected error counter is incremented).

The following example shows how the minimum and maximum input values are recorded:

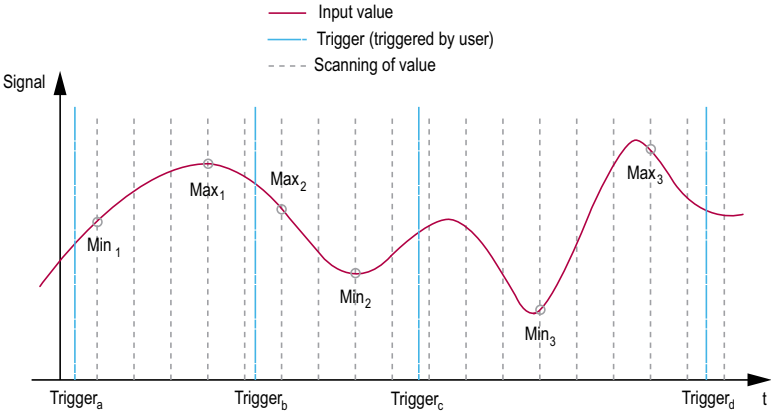

Trigger Event	Description
Trigger a	The function is started. The system notes the minimum and maximum values of the input signal. Ignore the Min./Max values registered by the status bit after the initial start.
Trigger b	The minimum value (Min1) and the maximum value (Max1) between Trigger a and Trigger b are given to the register and the new cycle is started. A status bit informs the user as soon as the values are valid.

Trigger Event	Description
Trigger c	The minimum value (Min2) and the maximum value (Max2) between Trigger b and Trigger c are given to the register and the new cycle is started. A status bit informs the user as soon as the values are valid.
Trigger d	The minimum value (Min3) and the maximum value (Max3) between Trigger c and Trigger d are given to the register and the new cycle is started. A status bit informs the user as soon as the values are valid.

Input Cycle

The electronic module has an Input cycle that can be configured separately for each individual channel. The order and cut-off frequency can be specified for each individual channel:

- Filter Order: 1...4 (default: 1)
- Filter Cut-off frequency: 1...65535 Hz (default: 500 Hz)

I/O Mapping Tab

Variables can be defined and named in the **I/O Mapping** tab. Additional information such as topological addressing is also provided in this tab.

This table describes the I/O Mapping:

Variable	Channel	Type	Default Value	Description														
Inputs	AnalogInput00	INT	-	Current value of input 0														
														
	AnalogInput03			Current value of input 3														
	Status04	USINT	-	State of all inputs (Bits 0...3 not used)														
	<table border="1"> <tr> <td>Not used</td> <td rowspan="5">BOOL</td> <td rowspan="5">-</td> <td>-</td> </tr> <tr> <td>...</td> <td>...</td> </tr> <tr> <td>MinMaxStart00Readback</td> <td>Readback MinMax Start of input 0</td> </tr> <tr> <td>...</td> <td>...</td> </tr> <tr> <td>MinMaxStart03Readback</td> <td>Readback MinMax Start of input 3</td> </tr> </table>	Not used	BOOL	-	-	MinMaxStart00Readback	Readback MinMax Start of input 0	MinMaxStart03Readback	Readback MinMax Start of input 3					
		Not used			BOOL	-	-											
												
		MinMaxStart00Readback					Readback MinMax Start of input 0											
												
	MinMaxStart03Readback	Readback MinMax Start of input 3																
	MinInput00	INT	-	Minimum value of input 0														
	MaxInput00			Maximum value of input 0														
														
	MinInput03			Minimum value of input 3														
	MaxInput03			Maximum value of input 3														
	Status00	USINT	-	State of all inputs (Bits 5...7 not used)														
	<table border="1"> <tr> <td>Channel00OK</td> <td rowspan="5">BOOL</td> <td rowspan="5">-</td> <td>State of input 0 (0=OK)</td> </tr> <tr> <td>...</td> <td>...</td> </tr> <tr> <td>Channel03OK</td> <td>State of input 3 (0=OK)</td> </tr> <tr> <td>Not used</td> <td>-</td> </tr> <tr> <td>ConversionCycle</td> <td>Status conversion cycle bit (0=OK)</td> </tr> </table>	Channel00OK	BOOL	-	State of input 0 (0=OK)	Channel03OK	State of input 3 (0=OK)	Not used	-	ConversionCycle	Status conversion cycle bit (0=OK)					
		Channel00OK			BOOL	-	State of input 0 (0=OK)											
												
		Channel03OK					State of input 3 (0=OK)											
		Not used					-											
	ConversionCycle	Status conversion cycle bit (0=OK)																
	Status01	USINT	-	State of all inputs														
	<table border="1"> <tr> <td>Channel00underflow</td> <td rowspan="6">BOOL</td> <td rowspan="6">-</td> <td>Input 0 underflow (0=OK)</td> </tr> <tr> <td>...</td> <td>...</td> </tr> <tr> <td>Channel03underflow</td> <td>Input 3 underflow (0=OK)</td> </tr> <tr> <td>Channel00overflow</td> <td>Input 0 overflow (0=OK)</td> </tr> <tr> <td>...</td> <td>...</td> </tr> <tr> <td>Channel03overflow</td> <td>Input 3 overflow (0=OK)</td> </tr> </table>	Channel00underflow	BOOL	-	Input 0 underflow (0=OK)	Channel03underflow	Input 3 underflow (0=OK)	Channel00overflow	Input 0 overflow (0=OK)	Channel03overflow	Input 3 overflow (0=OK)			
		Channel00underflow			BOOL	-	Input 0 underflow (0=OK)											
												
		Channel03underflow					Input 3 underflow (0=OK)											
		Channel00overflow					Input 0 overflow (0=OK)											
												
	Channel03overflow	Input 3 overflow (0=OK)																
	Status02	USINT	-	Out of range status of all inputs (Bits 5...7 not used)														
	<table border="1"> <tr> <td>Channel00outofrange</td> <td rowspan="3">BOOL</td> <td rowspan="3">-</td> <td>Input 0 out of range (0=OK)</td> </tr> <tr> <td>...</td> <td>...</td> </tr> <tr> <td>Channel03outofrange</td> <td>Input 3 out of range (0=OK)</td> </tr> </table>	Channel00outofrange	BOOL	-	Input 0 out of range (0=OK)	Channel03outofrange	Input 3 out of range (0=OK)									
		Channel00outofrange			BOOL	-	Input 0 out of range (0=OK)											
...		...																
Channel03outofrange	Input 3 out of range (0=OK)																	

Variable	Channel	Type	Default Value	Description
Outputs	Status03	USINT	-	Command word of all outputs (Bits 0...3: not used)
	...	BOOL	None TRUE FALSE	...
	MinMaxStart00			Command bit of Start Min/Max of input 0 (1 = Start)

MinMaxStart03	Command bit of Start Min/Max of input 3 (1 = Start)			

For further generic descriptions, refer to I/O Mapping Tab Description ([see page 26](#)).

NOTE: All the bits dedicated to channel 2 and channel 3 are not used (bit=0) for the TM5SAI2H.

Cycle Time and I/O Update Time

This table gives the module characteristics allowing the TM5 Bus Cycle Time configuration:

Characteristic	Value (µs)	
	Default priority	High priority with trace function
Minimum cycle time	200 µs	300 µs
Minimum I/O update time	No limitation on Bus cycle time	

For further information, refer to TM5 Manager Configuration ([see page 23](#)).

TM5SAI2L and TM5SAI4L

Introduction

The TM5SAI2L and TM5SAI4L expansion electronic modules are 10 Vdc Analog Input electronic modules with 2 and 4 inputs respectively.

If you have wired your input for a voltage measurement, and you configure SoMachine for a current type of configuration, you may permanently damage the electronic module.

NOTICE

INOPERABLE EQUIPMENT

Verify that the physical wiring of the analog circuit is compatible with the software configuration for the analog channel.

Failure to follow these instructions can result in equipment damage.

For further information, refer to the Hardware Guide:

Reference	Refer to
TM5SAI2L	TM5SAI2L Electronic Module 2AI $\pm 10V/0-20mA/4-20mA$ 12 Bits (see <i>Modicon TM5, Analog I/O Modules, Hardware Guide</i>)
TM5SAI4L	TM5SAI4L Electronic Module 4AI $\pm 10V/0-20mA/4-20mA$ 12 Bits (see <i>Modicon TM5, Analog I/O Modules, Hardware Guide</i>)

I/O Configuration Tab

To configure the TM5SAI2L and TM5SAI4L electronic modules, select the **I/O Configuration** tab.

This table describes the modules parameters configuration:

Parameter		Value	Default Value	Description
General	Module address	0...250	Depends on the configuration	The address is automatically set when adding the modules. The address value depends on the order of adding the module in the SoMachine tree. The TM5ACBM15 support the possibility to change the address.
	Lower limit	-32768...32767	-32767	Specifies the lower measurement limit (<i>see page 123</i>).
	Upper limit	-32768...32767	32767	Specifies the upper measurement limit (<i>see page 123</i>).
	Input filter	Off level 2 level 4 level 8 level 16 level 32 level 64 level 128	Off	Definition of the filter level (<i>see page 124</i>).
	Input ramp limitation	Off 16383 8191 4095 2047 1023 511 255	Off	Specifies the limitation of input ramp (<i>see page 126</i>). NOTE: Parameter available if an input filter is selected.
	Bus base	TM5ACBM11 TM5ACBM15	TM5ACBM11	Specifies the bus base associated with the electronic module.
	Terminal block	TM5ACTB06 (only for TM5SAI2L) TM5ACTB12	TM5ACTB06 (for TM5SAI2L) TM5ACTB12 (for TM5SAI4L)	Specifies the terminal block associated with the electronic module.
	Channel 00	Channel type	±10 V 0...20 mA 4...20 mA	±10 V
Channel 01	Channel type	±10 V 0...20 mA 4...20 mA	±10 V	Specifies the channel type.

Parameter		Value	Default Value	Description
Channel 02	Channel type	±10 V 0...20 mA 4...20 mA	±10 V	Specifies the channel type.
Channel 03	Channel type	±10 V 0...20 mA 4...20 mA	±10 V	Specifies the channel type.

For further generic descriptions, refer to I/O Configuration Tab Description ([see page 26](#)).

NOTE: The channel 02 and channel 03 parameters are not available for the TM5SAI2L.

Analog Inputs

The input status is registered with a fixed offset with respect to the network cycle and is transferred in the same cycle.

Input Cycle

The electronic module is equipped with a configurable Input cycle. Filtering is deactivated for shorter cycle times.

If the Input cycle is active, then the channels are scanned in ms cycles. The time offset between the channels is 200 µs. The conversion takes place asynchronously to the network cycle. Refer to Cycle time and I/O update time ([see page 128](#))

Limit values

You can define 2 different type of limits:

- **Lower limit**
- **Upper limit**

The **Lower limit** value range is between -32768 to 32767. This value is applied on every channel of the module being configured.

NOTE: the **Lower limit** cannot be greater than the **Upper limit**.

Channel Configuration	Digital Value Behavior	Comments
± 10V	-10 V = -32768 +10 V = +32767	If the Lower limit value is configured between -32768 and +32767, the digital value is limited to the Lower limit value.
0...20 mA	0 mA = 0 20 mA = +32767	If the Lower limit value is configured between -32768 and 0, the digital value is limited to 0. If the Lower limit value is configured between 0 and 32 767, the digital value is limited to the Lower limit value.
4...20 mA	0 mA = -8192 4 mA = 0 20 mA = +32767	If the Lower limit is configured between -32768 and -8192, the digital value is limited to -8192. If the Lower limit is configured between -8192 and 32767, the digital value is limited to the Lower limit value.

The **Upper limit** value range is between -32768 to 32767. This value is applied on every channel of the module being configured.

NOTE: The **Upper limit** value cannot be less than the **Lower limit** value.

Channel Configuration	Digital Value Behavior	Comments
± 10V	-10 V = -32768 +10 V = +32767	If the Upper limit value is configured between -32768 and +32767, the digital value is limited to the Upper limit value.
0...20 mA	0 mA = 0 20 mA = +32767	If the Upper limit value is configured between -32768 and 0, the digital value stays at 0; hence, set the Upper limit value to a positive value. If the Upper limit value is configured between 1 and +32767, the digital value is limited to the Upper limit value.
4...20 mA	0 mA = -8192 4 mA = 0 20 mA = +32767	If the Upper limit value is configured between -32768 and -8192, the digital value is limited to -8192. If the Upper limit value is configured between -8192 and 32767, the digital value is limited to the Upper limit value.

Filter Level

The input value is evaluated according to the filter level. An input ramp limitation can then be applied using this evaluation.

Formula for the evaluation of the input value:

$$Value_{new} = Value_{old} - \frac{Value_{old}}{Filterlevel} + \frac{Inputvalue}{Filterlevel}$$

The following examples show the function of the input ramp limitation based on an input jump and a disturbance.

Example 1: The input value makes a jump from 8000 to 16000. The diagram displays the evaluated value with the following settings:

Input ramp limitation = 0

Filter level = 2 or 4

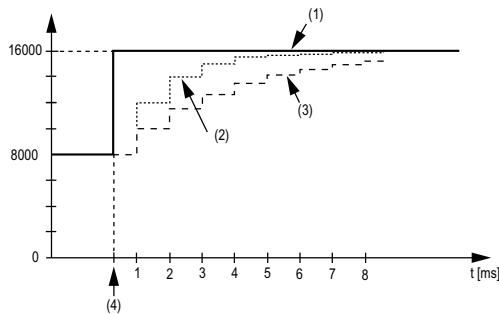

- 1 Input value.
- 2 Evaluated value: Filter level 2
- 3 Evaluated value: Filter level 4
- 4 Input jump

Example 2: A disturbance is imposed on the input value. The diagram shows the evaluated value with the following settings:

Input ramp limitation = 0

Filter level = 2 or 4

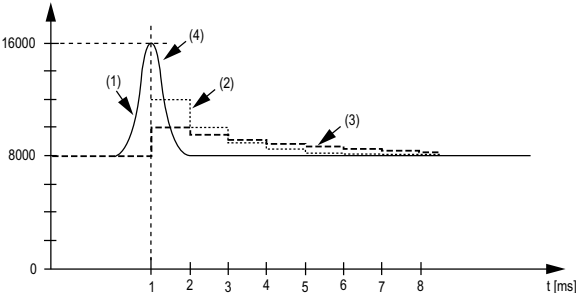

- 1 Input value
- 2 Evaluated value: Filter level 2
- 3 Evaluated value: Filter level 4
- 4 Disturbance (Spike)

Input Ramp Limitation

Input ramp limitation can only take place when a filter is used. Input ramp limitation is executed before filtering takes place.

The amount of the change in the input value is verified to make sure the specified limits are not exceeded. If the values are exceeded, the adjusted input value is equal to the old value \pm the limit value.

The input ramp limitation is well suited for suppressing disturbances (spikes). The following examples show the function of the input ramp limitation based on an input jump and a disturbance.

Example 1: The input value makes a jump from 8,000 to 17,000. The diagram displays the adjusted input value for the following settings:

Input ramp limitation = 2047

Filter level = 2

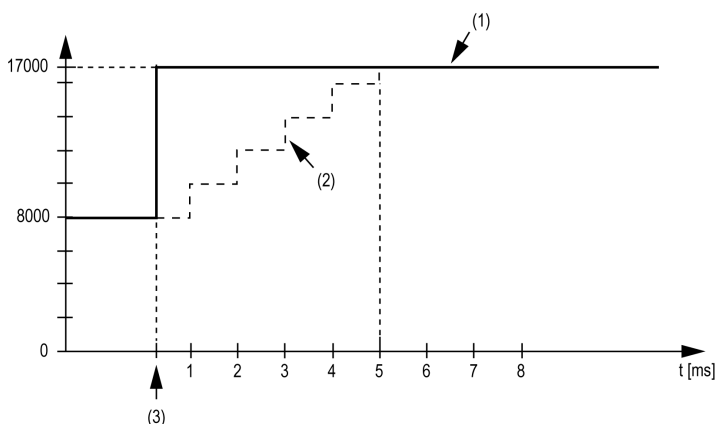

- 1 Input value
- 2 Internal adjusted input value before filter
- 3 Input jump

Example 2: A disturbance is imposed on the input value. The diagram shows the adjusted input value with the following settings:

Input ramp limitation = 2047

Filter level = 2

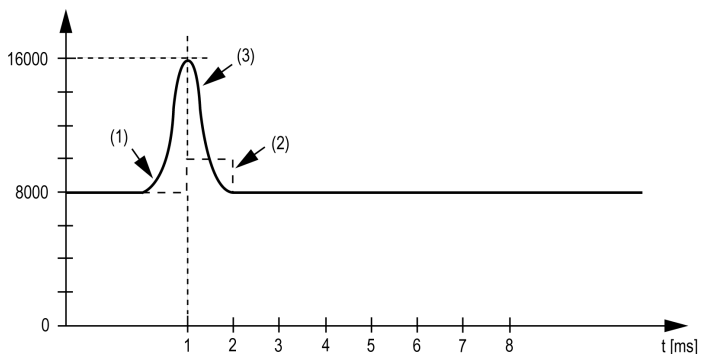

- 1 Input value
- 2 Internal adjusted input value before filter
- 3 Disturbance (Spike)

I/O Mapping Tab

Variables can be defined and named in the **I/O Mapping** tab. Additional information such as topological addressing is also provided in this tab.

This table describes the I/O Mapping:

Channel		Type	Default value	Description
Inputs	AnalogInput00	INT	-	Current value of the input 0

	AnalogInput03			Current value of the input 3
	StatusInput00	USINT	-	Status of analog input channels (see description below)

For further generic descriptions, refer to I/O Mapping Tab Description ([see page 26](#)).

NOTE: The bytes dedicated to channel 2 and channel 3 are not available for the TM5SAI2L.

Status Input Register

The **StatusInput00** byte describes the status of each input channel:

Bit	Description	Bits value
0-1	Channel 00 status	00: No error detected 01: Below lower limit value ¹ 10: Above upper limit value 11: Wire break ²
2-3	Channel 01 status	
4-5	Channel 02 status	
6-7	Channel 03 status	
¹ Channel Configuration 4...20 mA ² Channel Configuration ± 10V <u>Default setting:</u> The input value has a lower limit. Underflow monitoring is, therefore, not necessary. <u>After lower limit value changes:</u> The input value is limited to the set value. The status bit is set when the lower limit value is passed.		

NOTE: The bit dedicated to channel 2 and channel 3 are not used (bit=0) for the TM5SAI2L.

Cycle Time and I/O Update Time

This table gives the module characteristics allowing the TM5 Bus Cycle Time configuration:

Characteristic	Value (µs)	
	Without filter	With filter
Minimum cycle time	100	500
Minimum I/O update time	300	1000

For further information, refer to TM5 Manager Configuration ([see page 23](#)).

TM5SAI2PH and TM5SAI4PH

Introduction

The TM5SAI2PH and TM5SAI4PH expansion electronic modules are Analog Resistor Temperature electronic modules with 2 and 4 Inputs respectively.

NOTICE

INOPERABLE EQUIPMENT

Verify that the physical wiring of the analog circuit is compatible with the software configuration for the analog channel.

Failure to follow these instructions can result in equipment damage.

For further information, refer to the Hardware Guide:

Reference	Refer to
TM5SAI2PH	TM5SAI2PH Electronic Module 2AI PT100/PT1000 16 Bits (see <i>Modicon TM5, Analog I/O Modules, Hardware Guide</i>)
TM5SAI4PH	TM5SAI4PH Electronic Module 4AI PT100/PT1000 16 Bits (see <i>Modicon TM5, Analog I/O Modules, Hardware Guide</i>)

I/O Configuration Tab

To configure the TM5SAI2PH and TM5SAI4PH electronic modules, select the **I/O Configuration** tab.

This table describes the modules parameters configuration:

Parameter		Value	Default Value	Description
Function Model		3 wire connection 2 wire connection	3 wire connection	Specifies 3 wire connection or 2 wire connection.
General	Module address	0...250	Depends on the configuration	The address is automatically set when adding the modules. The address value depends on the order of adding the module in the SoMachine tree. The TM5ACBM15 supports the possibility to change the address.
	I/O cycle counter	Off On	Off	Enable or disable I/O cycle counter. On: the I/OCycleCounter word is added in the I/O Mapping tab.
	Input filter	66.7 40 33.3 20 16.7 10 2 1	20 ms	Specifies the filter time on the module.
	Bus base	TM5ACBM11 TM5ACBM15	TM5ACBM11	Specifies the bus base associated with the electronic module.
	Terminal block	TM5ACTB06 (only for TM5SAI2PH) TM5ACTB12	TM5ACTB06 (for TM5SAI2PH) TM5ACTB12 (for TM5SAI4PH)	Specifies the terminal block associated with the electronic module.
Channel 00	Sensor type	PT100 PT1000 0.1...4500 ohm, 0.1 ohm/bit, 0.05...2250 ohm, 0.05 ohm/bit off	PT100	Specifies the sensor type (<i>see page 132</i>). Off: the Temperature00 channel is removed from the I/O Mapping tab.

Parameter		Value	Default Value	Description
Channel 01	Sensor type	PT100 PT1000 0.1...4500 ohm, 0.1 ohm/bit, 0.05...2250 ohm, 0.05 ohm/bit off	PT100	Specifies the sensor type (see page 132). Off: the Temperature01 channel is removed from the I/O Mapping tab.
Channel 02	Sensor type	PT100 PT1000 0.1...4500 ohm, 0.1 ohm/bit, 0.05...2250 ohm, 0.05 ohm/bit off	PT100	Specifies the sensor type (see page 132). Off: the Temperature02 channel is removed from the I/O Mapping tab.
Channel 03	Sensor type	PT100 PT1000 0.1...4500 ohm, 0.1 ohm/bit, 0.05...2250 ohm, 0.05 ohm/bit off	PT100	Specifies the sensor type (see page 132). Off: the Temperature03 channel is removed from the I/O Mapping tab.

For further generic descriptions, refer to I/O Configuration Tab Description ([see page 26](#)).

NOTE: The channel 02 and channel03 parameters are not available for the TM5SAI2PH.

NOTE: To economize cycle time, do not activate a channel when there is no sensor connected.

Analog Inputs

The converted analog values are output by the electronic module in the registers. Different resistance or temperature measurements result in different value ranges and data types.

Timing Setting

The timing setting for data acquisition is made using the converter hardware. All activated inputs are converted during each conversion cycle.

Conversion Time

The conversion time for the channels depends on their use. For the formulas listed in the table, 'n' corresponds to the number of channels that are agitated.

Channel Uses	Conversion Time
1 channel	1 x Input Filter time
n channels with the same sensor type	n x (Input Filter time + 20 ms)
n channels with different sensor types	n x (2 x Input Filter time + 20 ms)

Reduce Conversion Time

If an input is not necessary, it can be deactivated by setting the sensor type to Off, thereby reducing the refresh time.

The time saved is: Timesaving = 2 x 20 ms + Input Filter time

The Input Filter time is the conversion time for the remaining channels.

Sensor Type and Channel Deactivation

The electronic module is designed for temperature and resistance measurement. The sensor type must be specified because of the different adjustment values for temperature and resistance. To save time, individual channels can be deactivated by setting the sensor type to Off.

This table shows the sensor types:

Sensor Types	Digital Value	Temperature °C (°F)	Resolution
Sensor type PT100	-2000...8500	-200...850 (-328...1562)	0.1°C(0.18°F)
Sensor type PT1000	-2000...8500	-200...850 (-328...1562)	0.1°C (0.18°F)
Resistance measurement 0.1...4500 Ohm	1...45000	–	0.1 Ohm
Resistance measurement 0.05...2250 Ohm	1...45000	–	0.05 Ohm

I/O Mapping Tab

Variables can be defined and named in the **I/O Mapping** tab. Additional information such as topological addressing is also provided in this tab.

This table describes the I/O Mapping:

Variable	Channel	Type	Default Value	Description
Inputs	Temperature00	INT	-	Current value of the input 0

	Temperature03			Current value of the input 3
	IOCycleCounter	USINT	-	I/O cycle counter
StatusInput00		USINT	-	Status of analog input channels (see description below)

For further generic descriptions, refer to I/O Mapping Tab Description ([see page 26](#)).

NOTE: The bytes dedicated to channel 2 and channel 3 are not available for the TM5SAI2PH.

Status Input Register

The **StatusInput** byte describes the status of each input channel:

Bit	Description	Bits Value
0-1	Channel 00 status	00: No error detected
2-3	Channel 01 status	01: Below minimum value
4-5	Channel 02 status	10: Above maximum value
6-7	Channel 03 status	11: Broken wire detected

NOTE: The bit dedicated to channel 2 and channel 3 are not used (bit=0) for the TM5SAI2PH.

Limit Analog Value

In addition to the status information, the analog value is set to the values listed below, by default, when a detected error occurs. The analog value is limited to the new values if the limit values were changed.

Detected ErrorType	Temperature Measurement Digital Value for Detected Error	Resistance Measurement Digital Value for Detected Error
Wire break	+32767 (7FFF hex)	65535 (FFFF hex)
Above upper limit value	+32767 (7FFF hex)	65535 (FFFF hex)
Below lower limit value	-32767 (8001 hex)	0 (0 hex)
Invalid value	-32768 (8000 hex)	65535 (FFFF hex)

Cycle Time and I/O Update Time

This table gives the module characteristics allowing the TM5 Bus Cycle Time configuration:

Characteristic	Value (μ s)	
	1 Input	n Inputs
Minimum cycle time	100	
Minimum I/O update time	Equal to the filter time	$n * (200 \text{ ms} + \text{filter time})$

For further information, refer to TM5 Manager Configuration ([see page 23](#)).

TM5SAI2TH and TM5SAI6TH

Introduction

The TM5SAI2TH and TM5SAI6TH expansion electronic modules are Analog Temperature Sensor with 2 and 6 Inputs respectively.

NOTICE

INOPERABLE EQUIPMENT

Verify that the physical wiring of the analog circuit is compatible with the software configuration for the analog channel.

Failure to follow these instructions can result in equipment damage.

For further information, refer to the Hardware Guide:

Reference	Refer to
TM5SAI2TH	TM5SAI2TH Electronic Module 2AI Thermocouple J/K/N/S 16 Bits (see <i>Modicon TM5, Analog I/O Modules, Hardware Guide</i>)
TM5SAI6TH	TM5SAI6TH Electronic Module 6AI Thermocouple J/K/N/S 16 Bits (see <i>Modicon TM5, Analog I/O Modules, Hardware Guide</i>)

I/O Configuration Tab

To configure the TM5SAI2TH and TM5SAI6TH electronic modules, select the **I/O Configuration** tab.

This table describes the modules parameters configuration:

Parameter	Value	Default Value	Description
Function model	Internal compensation temperature External compensation temperature	Internal compensation temperature	Refer to External Compensation Temperature (see page 137).

Parameter		Value	Default Value	Description
General	Module address	0...250	Depends on the configuration	The address is automatically set when adding the modules. The address value depends on the order of adding the module in the SoMachine tree. The TM5ACBM15 supports the possibility to change the address.
	I/O cycle counter	Off On	Off	Enable/disable I/O cycle counter. On: the IO Cycle Counter word is added to the I/O Mapping tab.
	Input filter	66.7 40 33.3 20 16.7 10 2 1	20 ms	Specifies the filter time on the module.
	Sensor type	J K N S ±32767 µV, 1 µV/bit ±65534 µV, 2 µV/bit	J	Specifies the sensor type (see page 138).
	Enable channel 00	On Off	On	Selectively enabling of not used channels reduces the electronic module cycle time. Off: the Temperature00 word is removed from the I/O Mapping tab.
	...			
	Enable channel 05	On Off	On	Selectively enabling of not used channels reduces the electronic module cycle time. Off: the Temperature05 word is removed from the I/O Mapping tab.
	Bus base	TM5ACBM11 TM5ACBM15	TM5ACBM11	Specifies the bus base associated with the electronic module.
	Terminal block	TM5ACTB06 TM5ACTB12	TM5ACTB06	Specifies the terminal block associated with the electronic module.

For further generic descriptions, refer to I/O Configuration Tab Description ([see page 26](#)).

NOTE: The channel 02... channel05 parameters are not available for the TM5SAI2TH.

NOTE: To economize cycle time, do not activate a channel when there is no sensor connected.

Analog Inputs

The converted analog values are output by the electronic module in the registers. The sensor type configured affects the value ranges.

Raw Value Measurement

If a sensor type other than J, K, N, or S is used, the terminal temperature must be measured on at least one input. Based on this value, the user must perform a terminal temperature compensation.

Timing Setting

The timing setting for data acquisition is made using the converter hardware. All switched on inputs are converted during each conversion cycle. A terminal temperature measurement also takes place.

If an input is not necessary, it can be deactivated by setting the channel to Off, thereby reducing the refresh time. The measurement of the terminal temperature is deactivated.

Conversion Time

The conversion time depends on the number of channels used. For the formulas listed in the table, 'n' corresponds to the number of channels that are activated.

Channel Uses	Conversion Time
n channels	$(n \times (2 \times \text{Input Filter time} + 200 \mu\text{s}))$
1 channel	Corresponds to the Input Filter time

Terminal Temperature (Cold Junction) Compensation

General information

When using thermocouples, it is necessary to measure the temperature at the terminal connections of the TM5SAIxTH in order to calculate an accurate absolute temperature at the measuring point of the thermocouple.

NOTE: At least one terminal temperature sensor is required to determine the temperature measured by the connected thermocouples. Otherwise, a value of 7FFF hex is calculated for all the connected thermocouples.

The accuracy of the temperature measurement of the connected thermocouples is a function of the number of terminal temperature sensors connected to the block.

A terminal temperature compensation junction is useful for the following applications:

- When there is a large distance between the controller and point of measurement.
- To increase precision.

Bridging large distances

When there is a large distance between the controller and the point of measurement, use a terminal temperature compensation junction. The thermocouple voltage is supplied via copper cable from the terminal temperature compensation junction to the terminal on the TM5SAIxTH. The temperature measured at the terminal temperature compensation junction is stored in the I/O area of the TM5SAIxTH electronic module. The TM5SAIxTH electronic module calculates the thermocouple temperature internally from the measured voltage and the reference junction temperature value (per channel).

Increased precision

To increase the precision, use a terminal temperature compensation junction. The construction of the terminal temperature compensation junction is the same as described above. The installation of a terminal temperature compensation junction is especially helpful in the following cases:

- There is a slice next to the TM5SAIxTH that requires more than 1 W.
- There is no slice next to the TM5SAIxTH.
- With strongly fluctuating ambient conditions (draft, temperature).

NOTE: If the J, K, N and S types are used, you must select the external compensation.

Sensor Type and Channel Deactivation

The electronic module is designed for various sensor types. The sensor type must be specified because of the different adjustment values. The default setting for all channels is ON. To save time, individual channels can be deactivated.

This table shows the code corresponding sensor types:

Sensor Types
Sensor type J: -210...1200 °C (-346...2192 °F), digital value: -2100...12000
Sensor type K: -270...1372 °C (-454...2501 °F), digital value: -2700...13720
Sensor type N: -270...1300 °C (-454...2372 °F), digital value: -2700...13000
Sensor type S: -50...1768 °C (-58...3214 °F), digital value: -500...17680
Raw value without linearization and terminal temperature compensation. Resolution 1 µV for a measurement range of ±32.767 mV.
Raw value without linearization and terminal temperature compensation. Resolution 2 µV for a measurement range of ±65.534 mV.

I/O Mapping Tab

Variables can be defined and named in the **I/O Mapping** tab. Additional information such as topological addressing is also provided in this tab.

This table describes the I/O Mapping:

Variable	Channel	Type	Default Value	Description
Inputs	Temperature00	INT	-	Value of the input 0

	Temperature05			Value of the input 5
	IOCycleCounter	USINT	-	IO cycle counter
	StatusInput00	USINT	-	Status of analog input channels (see description below)
Outputs	ExternalCompensationTemperature	INT	-	External compensation temperature

For further generic descriptions, refer to I/O Mapping Tab Description ([see page 26](#)).

NOTE: The channel 2...5 parameters are not available for the TM5SAI2TH.

Status Input Register

The status byte describes the status of each input channel:

Status	Bit	Description	Bits Value
StatusInput00	0-1	Channel 00 status	00: No error detected 01: Below lower limit value 10: Above upper limit value 11: Broken wire detected
	2-3	Channel 01 status	
	4-5	Channel 02 status	
	6-7	Channel 03 status	
StatusInput01	0-1	Channel 04 status	00: No error detected 01: Below minimum value 10: Above maximum value 11: Broken wire detected
	2-3	Channel 05 status	
	4-5	Not used	
	6-7	Not used	

NOTE: The bit dedicated to channel 2...5 are not used (bit=0) for the TM5SAI2TH.

The **Statusinput01** byte is not available for the TM5SAI2TH.

Cycle Time and I/O Update Time

This table gives the module characteristics allowing the TM5 Bus Cycle Time configuration:

Characteristic	Value (μ s)	
	1 Input	n Inputs
Minimum cycle time	150	
Minimum I/O update time	Equal to the filter time	$n * (2 * \text{filter time} + 200 \text{ ms})$

For further information, refer to TM5 Manager Configuration ([see page 23](#)).

TM5SAO2H and TM5SAO2L

Introduction

The TM5SAO2H and TM5SAO2L expansion electronic modules are analog output electronic modules with 2 outputs, ± 10 Vdc / 0 to 20 mA.

If you have wired your output for a voltage measurement, and you configure SoMachine for a current type of configuration, you may permanently damage the electronic module.

<i>NOTICE</i>
INOPERABLE EQUIPMENT Verify that the physical wiring of the analog circuit is compatible with the software configuration for the analog channel. Failure to follow these instructions can result in equipment damage.

For further information, refer to the Hardware Guide:

Reference	Refer To
TM5SAO2H	TM5SAO2H Electronic Module 2AO ± 10 V/0-20mA 16 Bits (see <i>Modicon TM5, Analog I/O Modules, Hardware Guide</i>)
TM5SAO2L	TM5SAO2L Electronic Module 2AO ± 10 V/0-20mA 12 Bits (see <i>Modicon TM5, Analog I/O Modules, Hardware Guide</i>)

I/O Configuration Tab

To configure the TM5SAO2H and TM5SAO2L electronic modules, select the **I/O Configuration** tab.

This table describes the modules parameters configuration:

Parameter		Value	Default Value	Description
General	Module address	0...250	Depends on the configuration	The address is automatically set when adding the modules. The address value depends on the order of adding the module in the SoMachine tree. The TM5ACBM15 supports the possibility to change the address.
	Bus base	TM5ACBM11 TM5ACBM15	TM5ACBM11	Specifies the bus base associated with the electronic module.
	Terminal block	TM5ACTB06 TM5ACTB12	TM5ACTB06	Specifies the terminal block associated with the electronic module.
Channel00	Channel type	±10 V 0...20 mA	±10 V	Specifies the channel type.
Channel01	Channel type	±10 V 0...20 mA	±10 V	Specifies the channel type.

For further generic descriptions, refer to I/O Configuration Tab Description ([see page 26](#)).

I/O Mapping Tab

Variables can be defined and named in the **I/O Mapping** tab. Additional information such as topological addressing is also provided in this tab.

This table describes the I/O Mapping:

Variable	Channel	Type	Description
Outputs	AnalogOutput00	INT	Command word of the output 0
	AnalogOutput01		Command word of the output 1

For further generic descriptions, refer to I/O Mapping Tab Description ([see page 26](#)).

Cycle Time and I/O Update Time

This table gives the module characteristics allowing the TM5 Bus Cycle Time configuration:

Characteristic	Value (µs)	
	TM5SAO2H	TM5SAO2L
Minimum cycle time	200	250
Minimum I/O update time	200	< 300

For further information, refer to TM5 Manager Configuration ([see page 23](#)).

TM5SAO4H and TM5SAO4L

Introduction

The TM5SAO4H and TM5SAO4L electronic modules are analog outputs electronic modules with 4 outputs, ± 10 Vdc / 0 to 20 mA.

If you have wired your output for a voltage measurement, and you configure SoMachine a current type of configuration, you may permanently damage the electronic module.

NOTICE

INOPERABLE EQUIPMENT

Verify that the physical wiring of the analog circuit is compatible with the software configuration for the analog channel.

Failure to follow these instructions can result in equipment damage.

For further information, refer to the Hardware Guide:

Reference	Refer To
TM5SAO4H	TM5SAO4H Electronic Module 4AO ± 10 V/0-20mA 16 Bits (see <i>Modicon TM5, Analog I/O Modules, Hardware Guide</i>)
TM5SAO4L	TM5SAO4L Electronic Module 4AO ± 10 V/0-20mA 12 Bits (see <i>Modicon TM5, Analog I/O Modules, Hardware Guide</i>)

I/O Configuration Tab

To configure the TM5SAO4H and TM5SAO4L electronic modules, select the **I/O Configuration** tab.

This table describes the modules parameters configuration:

Parameter		Value	Default Value	Description
General	Module address	0...250	Depends on the configuration	The address is automatically set when adding the modules. The address value depends on the order of adding the module in the SoMachine tree. The TM5ACBM15) supports the possibility to change the address.
	Bus base	TM5ACBM11 TM5ACBM15	TM5ACBM11	Specifies the bus base associated with the electronic module.
	Terminal block (not available for TM5SAO4L)	TM5ACTB12	TM5ACTB06	Specifies the terminal block associated with the electronic module.
Channel00 ... Channel03	Channel type	±10 V 0...20 mA	±10 V	Specifies the channel type.

For further generic descriptions, refer to I/O Configuration Tab Description ([see page 26](#)).

I/O Mapping Tab

Variables can be defined and named in the **I/O Mapping** tab. Additional information such as topological addressing is also provided in this tab.

This table describes the I/O Mapping:

Channel		Type	Description
Outputs	AnalogOutput00	INT	Command word of the output 0
	AnalogOutput01		Command word of the output 1
	AnalogOutput02		Command word of the output 2
	AnalogOutput03		Command word of the output 3

For further generic descriptions, refer to I/O Mapping Tab Description ([see page 26](#)).

Cycle Time and I/O Update Time

This table gives the module characteristics allowing the TM5 Bus Cycle Time configuration:

Characteristic	Value (μs)	
	TM5SAO4H	TM5SAO4L
Minimum cycle time	200	250
Minimum I/O update time	200	< 400

For further information, refer to TM5 Manager Configuration ([see page 23](#)).

Chapter 5

TM5 Analog Strain Gauge Electronic Module

Overview

This chapter describes the configuration of the TM5SEAISG electronic module.

To add an expansion electronic module and to access the configuration screens, refer to Adding an expansion electronic module ([see page 26](#)).

What Is in This Chapter?

This chapter contains the following topics:

Topic	Page
TM5SEAISG	148
Configuring a Strain Gauge Electronic Module	149
Module Configuration	152
Effective Resolution	153

TM5SEAISG

Introduction

The TM5SEAISG is an analog electronic module which allows to convert the output of a 4-wire or 6-wire full-bridge strain gauge to a numeric value.

For further information, refer to the TM5SEAISG Analog Strain Gauge Input Electronic Module (see *Modicon TM5, Analog I/O Modules, Hardware Guide*) and the TM5 IoDrvTM5SEAISG Strain Gauge Library Guide. (see *Modicon TM5, Strain Gauge IoDrvTM5SEAISG, Library Guide*)

Configuring a Strain Gauge Electronic Module

First Step

Add the TM5SEAISG module to the **TM5 Manager** of your controller.

I/O Configuration Tab

To configure the TM5SEAISG electronic modules, double-click the module and select the **I/O Configuration** tab.

The table describes the module parameter configuration:

Parameter		Value	Default Value	Description
General	Module address	0...250	Depends on the configuration	The address is automatically set when adding the modules. The address value depends on the order of adding the module in the SoMachine tree. The TM5ACBM15 bus base allows you to change the address.
	Bus base	TM5ACBM11 TM5ACBM15	TM5ACBM11	Specifies the bus base associated with the electronic module.
	Terminal block	TM5ACTB12	TM5ACTB12	Specifies the terminal block associated with the electronic module.
Module Configuration	ADC cycle time	50...2000	400	Specifies the cycle time (in μ s) for the ADC (Analog/Digital converter).

For further generic descriptions, refer to I/O Configuration Tab Description ([see page 26](#)).

I/O Mapping Tab

Variables can be defined and named in the **I/O Mapping** tab. Additional information such as topological addressing is also provided in this tab.

The table describes the I/O Mapping:

Channel		Type	Default Value	Description
Inputs	StatusInput00	USINT	–	Status of analog input channel
	AnalogInput00	DINT	–	Current value of the input 0. This is the raw value read by the TM5SEAISG.
Outputs	ConfigOutput00	USINT	–	Commands the ADC configuration (see page 151).

For further generic descriptions, refer to I/O Mapping Tab Description ([see page 27](#)).

Status Input Register

The table describes the **StatusInput00** status register:

Status	Bit	Bits Value
StatusInput00	0	0: ADC value is valid 1: ADC value is not valid
	1	0: No error detected 1: Broken wire detected
	2	This bit is only relevant in synchronous mode. 0: ADC runs synchronously with the TM5 Bus 1: ADC is not run synchronous with the TM5 Bus
	3-7	Reserved

Analog Input Register

The **AnalogInput00** channel contains the raw value of the ADC for the full-bridge strain gauge with 24 bit resolution.

The table describes the **AnalogInput00** values:

Value	Description
FF80 0001...007F FFFF hex	Valid value
007F FFFF hex	Overflow
FF80 0001 hex	Underflow
FF80 0000 hex	Invalid value

ADC Configuration Register

The table describes the **ConfigOutput00** ADC configuration register:

Bit	Value	Description	Value
0-3	0000 hex	Data rate (samples per second):	2.5
	0001 hex		5
	0010 hex		10
	0011 hex		15
	0100 hex		25
	0101 hex		30
	0110 hex		50
	0111 hex		60
	1000 hex		100
	1001 hex		500
	1010 hex		1000
	1011 hex		2000
	1100 hex		3750
	1101 hex		7500
	1110 hex		Synchronous mode (<i>see page 152</i>)
1111 hex	Reserved		
4-6	000 hex	Bridge factor	16 mV/Vdc
	001 hex		8 mV/Vdc
	010 hex		4 mV/Vdc
	011 hex		2 mV/Vdc
	100 hex		256 mV/Vdc
	101 hex		128 mV/Vdc
	110 hex		64 mV/Vdc
	111 hex		32 mV/Vdc
7	0 hex	Reserved (must be 0)	

Module Configuration

Description

The module has 2 functioning modes:

- Synchronous
- Asynchronous

Synchronous Mode

The ADC is synchronously read with the TM5 Bus when:

- The bits 0...3 of the ADC Configuration Register **ConfigOutput00** are set with the value 1110 hex.
- The ADC cycle time is $\geq 1/4$ the TM5 Bus cycle time. For further information, refer to Analog Input Register ([see page 150](#)).
- The ADC cycle time is a multiple integer of the configured cycle time of the TM5 Bus.

NOTE: AnalogInput00 is set to FF80 0000 hex if the electronic module is configured with values outside these limits.

Asynchronous Mode

When the ADC is asynchronously read with the TM5 bus, the electronic module attempts to maintain to the set ADC cycle time as closely as possible without being synchronized to the TM5 Bus and the bit 2 of *StatusInput00* is set to 1 (see Status Input Register table ([see page 150](#))).

The following table describes the jitter, down time and settling time:

Characteristics		Values
Jitter	ADC cycle times <1500 μ s	$\pm 1 \mu$ s max.
	ADC cycle times >1500 μ s	$\pm 4 \mu$ s max.
Down time on the TM5 Bus		50 μ s + (TM5 Bus cycle time/128)
Settling time ¹		150 x TM5 Bus cycle time
¹ The settling time is the time between the falling edge of the valid bit (bit 0 in the status register) and the falling edge of the ADC synchronous bit (bit 2 in the status register).		

Effective Resolution

Overview

Through the Sigma-Delta conversion method of the analog signals on the TM5SEAISG, there is, in principal, an effective resolution of the displayed value.

If the ADC of the TM5SEAISG always outputs a 24 bit value, the attainable resolution according to calculation is always smaller than the 24 bit converter resolution. The effective resolution depends on the data rate and the bridge factor defined in the **ConfiguOutput00** ADC configuration register.

For example, a data rate of 2.5 Hz and a bridge factor of 2 mV/Vdc result in an effective resolution of 18.7 bits. Therefore, the amount of information in the low-order bits (marked in gray) is only natural in theory and is subject to heavy disturbances.

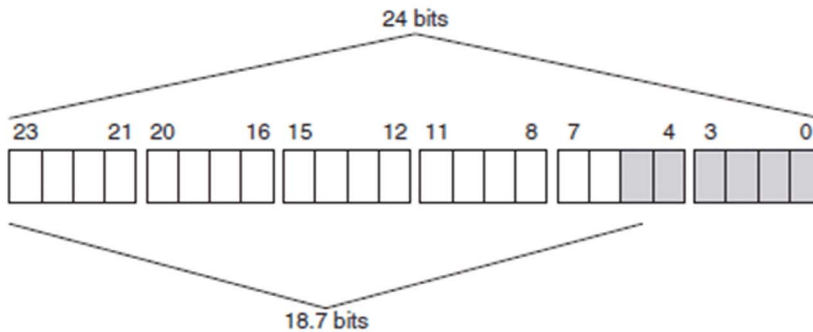

Strain Gauge Value

The **AnalogInput00** channel contains the raw value of the ADC for the full-bridge strain gauge with 24 bit resolution.

The tables below provides the effective resolution (in bits) of the full-bridge strain gauge value depending on the electronic module configuration (data rate, bridge factor). Refer to ADC Configuration Register ([see page 151](#)).

	Bridge factor			
	± 16 mV/Vdc	± 8 mV/Vdc	± 4 mV/Vdc	± 2 mV/Vdc
Data rate (Hz)	Bits	Bits	Bits	Bits
2.5	21.3	20.8	19.7	18.7
5	20.7	20.3	19.3	18.3
10	20.4	19.9	18.9	17.9
15	20.1	19.3	18.7	17.7
25	19.7	19.2	18.5	17.5
30	19.6	19.0	18.1	17.1
50	19.4	18.8	17.9	16.9
60	19.3	18.8	17.8	16.8
100	19.1	18.5	17.4	16.4
500	18.0	17.3	16.3	15.3
1000	17.2	16.5	15.6	14.6
2000	16.6	16.1	15.3	14.3
3750	16.2	15.7	14.7	13.7
7500	15.8	15.3	14.4	13.4

	Bridge factor			
	± 256 mV/Vdc	± 128 mV/Vdc	± 64 mV/Vdc	± 32 mV/Vdc
Data rate (Hz)	Bits	Bits	Bits	Bits
2.5	23	22.6	22.1	21.7
5	22.3	22.4	21.9	21.3
10	22.3	22	21.6	21
15	22	21.7	21.3	20.7
25	21.8	21.4	21.1	20.5
30	21.7	21.3	20.8	20.4
50	21.3	21.1	20.5	19.9
60	21.3	20.9	20.4	19.8

	Bridge factor			
	$\pm 256 \text{ mV/Vdc}$	$\pm 128 \text{ mV/Vdc}$	$\pm 64 \text{ mV/Vdc}$	$\pm 32 \text{ mV/Vdc}$
Data rate (Hz)	Bits	Bits	Bits	Bits
100	20.9	20.7	20.2	19.6
500	20.1	19.6	19.1	18.6
1000	19	18.6	18.1	17.5
2000	18.5	18.1	17.8	17
3750	18.1	17.8	17.3	16.6
7500	17.7	17.3	16.9	16.2

Chapter 6

TM5 Expert I/O Electronic Modules

Introduction

This chapter provides information to configure expert I/O expansion electronic modules.

To add expansion electronic modules and access to the configuration screens, refer to Adding an expansion electronic module ([see page 26](#)).

What Is in This Chapter?

This chapter contains the following topics:

Topic	Page
TM5SE1IC02505	158
TM5SE1IC01024	162
TM5SE2IC01024	166
TM5SE1SC10005	170

TM5SE1IC02505

Introduction

The TM5SE1IC02505 expansion electronic module is a 5 Vdc or 24 Vdc Expert Inputs electronic module with 1 input channel for ABR incremental encoder.

The encoder signal is counted as shown below:

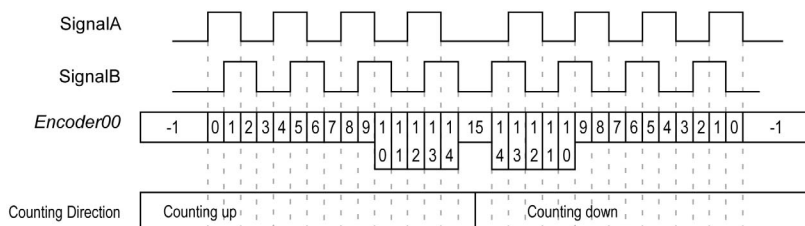

For further information, refer to TM5SE1IC02505 Electronic Module 1 HSC INC 250 kHz 5 Vdc (see *Modicon TM5, Expert Modules (High Speed Counter), Hardware Guide*).

I/O Configuration Tab

To configure the TM5SE1IC02505 electronic module, select the **I/O Configuration** tab.

This table describes the module parameters configuration:

Parameter		Value	Default Value	Description
Function model		16-bit counter 32-bit counter	16-bit counter	Define the counter value range: <ul style="list-style-type: none"> ● 16-bit: -32768...+32767 ● 32-bit: -2147483648...+2147483647
General	Module address	0...250	Depends on configuration	The address is automatically set when adding the modules. The address value depends on the order of adding the module in the SoMachine tree. The TM5ACBM15 supports the possibility to change the address.
	Bus base	TM5ACBM11 TM5ACBM15	TM5ACBM11	Specifies the bus base associated with the electronic module.
	Terminal block	TM5ACTB12	TM5ACTB12	Specifies the terminal block associated with the electronic module.
	24 V I/O segment external current	0...300 mA	300 mA	24 V I/O segment external current on TM5 power supply bus. Refer to System Planning and Installation Guide.

Parameter		Value	Default Value	Description
Counter00	Preset value	-32768...32767 (16-bit) - 2147483648...2147483647 (32-bit)	0	Homing preset value for counter; the value set here is applied to the counter value upon completion of the referencing process.
	Reference pulse	Negative edge Positive edge	Negative edge	Selects edge of reference pulse for homing.
	Reference enable switch	Off On (active low) On (active high)	Off	Digital input 00 used as reference enable switch.

For further generic descriptions, refer to I/O Configuration Tab Description ([see page 26](#)).

I/O Mapping Tab

Variables can be defined and named in the **I/O Mapping** tab. Additional information such as topological addressing is also provided in this tab.

This table describes the **I/O Mapping**:

Channel		Type	Default value	Description
Inputs	PowerSupply	USINT	-	Status encoder supply (bits 2...7: not used)
	PowerSupply00	BOOL	-	Status encoder supply 24 Vdc (0=OK)
	PowerSupply01			Status encoder supply 5 Vdc (0=OK)
	DigitalInput	USINT	-	State of all digital inputs (bits 6...7: not used)
	SignalA	BOOL	-	Encoder Signal A
	SignalB	BOOL		Encoder Signal B
	SignalR	BOOL		Encoder Reference Impulse
	DigitalInput00	BOOL		State of digital input 0
	DigitalInput01	BOOL		State of digital input 1
	Encoder00	INT	-	Incremental encoder
	StatusInput00	USINT	-	Status incremental encoder 00 (see below)
Outputs	ReferenceModeEncoder00	USINT	-	Reference mode incremental encoder 00

For further generic descriptions, refer to I/O Mapping Tab Description ([see page 26](#)).

StatusInput00 Register

This register contains information regarding whether the referencing process is off, active, or complete.

This table describes the **StatusInput00** register:

Bit	Description
0-1	Always 0.
2	When the referencing is ON, this bit is always 1 after the first reference impulse. When the referencing is OFF, this bit is always 0.
3	When the referencing is ON, this bit toggles after each completed reference. When the referencing is OFF, this bit is always 0.
4	This bit is always 1 after the first reference impulse.
5...7	Free-running counter, increased with each reference impulse.

Example:

Register Value		Description
00000000 bin	00 hex	Referencing off or already in progress.
00111100 bin	3C hex	First reference complete, reference value applied in the Encoder00 register.
xxx11100 bin	xB hex	Bits 5...7 are changed sequentially with each reference impulse.
xxx1x100 bin	xx hex	Bits changed continuously with the continuous referencing setting. With every reference impulse, the reference value is applied to the Encoder00 register.

ReferenceModeEncoder00 Register

This register determines the encoder reference mode.

This table describes the **ReferenceModeEncoder00** register:

Bit	Value	Description
0-1	00	Referencing OFF
	01	One-time reference (single shot)
	11	Continuous referencing
2...5	0000	Bit permanently set = 0
6-7	00	Referencing OFF
	11	Bit permanently set = 1

Example:

Register Value		Description
00000000 bin	00 hex	Referencing OFF
11000001 bin	C1 hex	One-time reference (single shot). When starting over after the referencing process is complete, set this register to 00 hex. Then wait until the StatusInput00 also takes on the value x0 hex.
11000011 bin	C3 hex	Continuous referencing: referencing occurs at every reference pulse.

Cycle Time and I/O Update Time

This table gives the module characteristics allowing the TM5 Bus Cycle Time configuration:

Characteristic	Value
Minimum cycle time	128 μ s
Maximum cycle time	16 ms
Minimum I/O update time	128 μ s

For further information, refer to TM5 Manager Configuration ([see page 23](#)).

TM5SE1IC01024

Introduction

The TM5SE1IC01024 expansion electronic module is a 24 Vdc Expert input electronic module with 1 input channel for ABR incremental encoder.

For further information, refer to TM5SE1IC01024 Electronic Module 1 HSC INC 100 kHz 24 Vdc (see *Modicon TM5, Expert Modules (High Speed Counter), Hardware Guide*).

I/O Configuration Tab

To configure the TM5SE1IC01024 electronic module, select the **I/O Configuration** tab.

This table describes the module parameters configuration:

Parameter		Value	Default Value	Description
Function model		16-bit counter 32-bit counter	16-bit counter	Define the counter value range: <ul style="list-style-type: none"> ● 16-bit: -32768...+32767 ● 32-bit: -2147483648...+2147483647
General	Module address	0...250	Depends on configuration	The address is automatically set when adding the modules. The address value depends on the order of adding the module in the SoMachine tree. The TM5ACBM15 supports the possibility to change the address.
	Bus base	TM5ACBM11 TM5ACBM15	TM5ACBM11	Specifies the bus base associated with the electronic module.
	Terminal block	TM5ACTB12	TM5ACTB12	Specifies the terminal block associated with the electronic module.
	24 V I/O segment external current	0...300 mA	300 mA	24 V I/O segment external current on TM5 power supply bus. Refer to System Planning and Installation Guide.
Counter00	Preset value	-32768...32767 (16-bit) -2147483648...2147483647 (32-bit)	0	Homing preset value for counter, the value set here is applied to the counter value upon completion of the referencing process.
	Reference pulse	Negative edge Positive edge	Negative edge	Selects edge of reference pulse for homing.
	Reference enable switch	Off On (active low) On (active high)	Off	Digital input 01 used as reference enable switch.

For further generic descriptions, refer to I/O Configuration Tab Description (see [page 26](#)).

I/O Mapping Tab

Variables can be defined and named in the **I/O Mapping** tab. Additional information such as topological addressing is also provided in this tab.

This table describes the **I/O Mapping**:

Variable	Channel	Type	Default Value	Description
Inputs	PowerSupply	USINT	-	Status encoder supply (bits 1...7: not used)
	PowerSupply00	BOOL	-	Status encoder supply (0=OK)
	DigitalInput	USINT	-	State of all digital inputs
	SignalA	BOOL	-	Encoder Signal A
	SignalB	BOOL		Encoder Signal B
	SignalR	BOOL		Encoder Signal R
	DigitalInput00	BOOL		State of digital input 0
	Encoder00	INT (16 bit counter) DINT (32 bit counter)	-	Incremental encoder
	StatusInput00	USINT	-	Status incremental encoder 00 (see below)
	Outputs	ReferenceModeEncoder00	USINT	-

For further generic descriptions, refer to I/O Mapping Tab Description ([see page 26](#)).

StatusInput00 Register

This register contains information regarding whether the referencing process is off, active, or complete.

This table describes the **StatusInput00** register:

Bit	Description
0-1	Always 0
2	Bit is always 1 after the first reference impulse
3	Toggle after each completed reference
4	Bit is always 1 after the first reference impulse
5...7	Free-running counter, increased with each reference impulse

Example:

Register Value		Description
00000000 bin	00 hex	Referencing off or already in progress
00111100 bin	3C hex	First reference complete, reference value applied in the Encoder00 register
xxx11100 bin	xB hex	Bits 5...7 are changed sequentially with each reference impulse
xxx1x100 bin	xx hex	Bits changed continuously with the setting continuous referencing. With every reference impulse, the reference value is applied to the Encoder00 register.

ReferenceModeEncoder00 Register

This register determines the encoder reference mode.

This table describes the **ReferenceModeEncoder00** register:

Bit	Value	Description
0-1	00	Referencing OFF
	01	One-time reference (single shot)
	11	Continuous referencing
2...5	0000	Bit permanently set = 0
6-7	00	Referencing OFF
	11	Bit permanently set = 1

Example:

Register Value		Description
00000000 bin	00 hex	Referencing OFF
11000001 bin	C1 hex	One-time reference (single shot) When starting over after the referencing process is complete, set this register to 00 hex. Then wait until the StatusInput00 also takes on the value 00 hex. Only then can the value C1 hex be written.
11000011 bin	C3 hex	Continuous referencing, referencing occurs at every reference pulse.

Cycle Time and I/O Update Time

This table gives the module characteristics allowing the TM5 Bus Cycle Time configuration:

Characteristic	Value
Minimum cycle time	128 μ s
Maximum cycle time	16 ms
Minimum I/O update time	128 μ s

For further information, refer to TM5 Manager Configuration ([see page 23](#)).

TM5SE2IC01024

Introduction

The TM5SE2IC01024 expansion electronic module is a 24 Vdc Expert input electronic module with 2 input channels for ABR incremental encoder.

For further information, refer to TM5SE2IC01024 Electronic Module 2 HSC INC 100 kHz 24 Vdc (see *Modicon TM5, Expert Modules (High Speed Counter), Hardware Guide*).

I/O Configuration Tab

To configure the TM5SE2IC01024 electronic module, select the **I/O Configuration** tab.

This table describes the module parameters configuration:

Parameter		Value	Default Value	Description
Function model		16-bit counter 32-bit counter	16-bit counter	Define the counter value range: <ul style="list-style-type: none"> ● 16-bit: -32768...+32767 ● 32-bit: -2147483648...+2147483647
General	Module address	0...250	Depends on configuration	The address is automatically set when adding the modules. The address value depends on the order of adding the module in the SoMachine tree. The TM5ACBM15 supports the possibility to change the address.
	Bus base	TM5ACBM11 TM5ACBM15	TM5ACBM11	Specifies the bus base associated with the electronic module.
	Terminal block	TM5ACTB12	TM5ACTB12	Specifies the terminal block associated with the electronic module.
	24 V I/O segment external current	0...600 mA	600 mA	24 V I/O segment external current on TM5 power supply bus. Refer to System Planning and Installation Guide.
Counter00	Preset value	-32768...32767 (16-bit) -2147483648...2147483647 (32-bit)	0	Homing preset value for counter, the value set here is applied to the counter value upon completion of the referencing process.
	Reference pulse	Negative edge Positive edge	Negative edge	Selects edge of reference pulse for homing.
	Reference enable switch	Off On (active low) On (active high)	Off	Digital input 00 used as reference enable switch.

Parameter		Value	Default Value	Description
Counter01	Preset value	-32768...32767 (16-bit) -2147483648...2147483647 (32-bit)	0	Homing preset value for counter, the value set here is applied to the counter value upon completion of the referencing process.
	Reference pulse	Negative edge Positive edge	Negative edge	Selects edge of reference pulse.
	Reference enable switch	Off On (active low) On (active high)	Off	Digital input 01 used as reference enable switch.

For further generic descriptions, refer to I/O Configuration Tab Description ([see page 26](#)).

I/O Mapping Tab

Variables can be defined and named in the **I/O Mapping** tab. Additional information such as topological addressing is also provided in this tab.

This table describes the **I/O Mapping**:

Variable	Channel	Type	Default Value	Description
Inputs	PowerSupply	USINT	-	Status encoder supply (bits 1...7: not used)
	PowerSupply00	BOOL	-	Status encoder supply (0=OK)
	DigitallInput	USINT	-	State of all digital inputs
	SignalA	BOOL	-	Encoder Signal A
	SignalB	BOOL	-	Encoder Signal B
	SignalR	BOOL	-	Encoder Signal R
	DigitallInput00	BOOL	-	State of digital input 0
	SignalA	BOOL	-	Encoder Signal A
	SignalB	BOOL	-	Encoder Signal B
	SignalR	BOOL	-	Encoder Signal R
	DigitallInput01	BOOL	-	State of digital input 1
	Encoder00	INT	-	Incremental encoder
	StatusInput00	USINT	-	Status incremental encoder 00 (see below)
	Encoder01	INT	-	Incremental encoder
	StatusInput01	USINT	-	Status incremental encoder 01 (see below)

Variable	Channel	Type	Default Value	Description
Outputs	ReferenceModeEncoder00	USINT	-	Reference mode incremental encoder 00
	ReferenceModeEncoder01	USINT	-	Reference mode incremental encoder 01

For further generic descriptions, refer to I/O Mapping Tab Description ([see page 26](#)).

StatusInput0x Register

This register contains information regarding whether the referencing process is off, active, or complete.

This table describes the **StatusInput0x** register:

Bit	Description
0-1	Always 0
2	Bit is always 1 after the first reference impulse
3	Toggle after each completed reference
4	Bit is always 1 after the first reference impulse
5...7	Free-running counter, increased with each reference impulse

Example:

Register Value		Description
00000000 bin	00 hex	Referencing off or already in progress.
00111100 bin	3C hex	First reference complete, reference value applied in the Encoder0x register.
xxx11100 bin	xB hex	Bits 5...7 are changed sequentially with each reference impulse.
xxx1x100 bin	xx hex	Bits changed continuously with the setting continuous referencing. With every reference impulse, the reference value is applied to the Encoder0x register.

ReferenceModeEncoder0x Register

This register determines the encoder reference mode.

This table describes the **ReferenceModeEncoder0x** register:

Bit	Value	Description
0-1	00	Referencing OFF
	01	One-time reference (single shot)
	11	Continuous referencing
2...5	0000	Bit permanently set = 0
6-7	00	Referencing OFF
	11	Bit permanently set = 1

Example:

Register Value		Description
00000000 bin	00 hex	Referencing OFF
11000001 bin	C1 hex	One-time reference (single shot) When starting over after the referencing process is complete, set this register to 00 hex. Then wait until the StatusInput0x also takes on the value 00 hex. Only then can the value C1 hex be written.
11000011 bin	C3 hex	Continuous referencing, referencing occurs at every reference pulse.

Cycle Time and I/O Update Time

This table gives the module characteristics allowing the TM5 Bus Cycle Time configuration:

Characteristic	Value
Minimum cycle time	128 μ s
Maximum cycle time	16 ms
Minimum I/O update time	128 μ s

For further information, refer to TM5 Manager Configuration ([see page 23](#)).

TM5SE1SC10005

Introduction

The TM5SE1SC10005 expansion electronic module is a 5 Vdc or 24 Vdc Expert Inputs electronic module with 1 input channel for SSI absolute encoder.

For further information, refer to TM5SE1SC10005 Electronic Module 1 HSC SSI 1 Mb 5 Vdc (see *Modicon TM5, Expert Modules (High Speed Counter), Hardware Guide*).

I/O Configuration Tab

To configure the TM5SE1SC10005 electronic module, select the **I/O Configuration** tab.

This table describes the module parameters configuration:

Parameter	Value	Default Value	Description	
General	Module address	0...250	Depends on configuration	The address is automatically set when adding the modules. The address value depends on the order of adding the module in the SoMachine tree. The TM5ACBM15 supports the possibility to change the address.
	Bus base	TM5ACBM11 TM5ACBM15	TM5ACBM11	Specifies the bus base associated with the electronic module.
	Terminal block	TM5ACTB12	TM5ACTB12	Specifies the terminal block associated with the electronic module.
	24 V I/O segment external current	0...300 mA	300 mA	24 V I/O segment external current on TM5 power supply bus. Refer to System Planning and Installation Guide.
Counter 00	Clock rate	1 MHz 500 kHz 250 kHz 125 kHz	1 MHz	Define the clock rate.
	Data format	Binary Gray	Binary	Data format of SSI encoder.
	Total SSI bit length	0...32	8	Number of bits sent by the SSI encoder per frame.
	Valid SSI bit length	0...32	8	Significant part of the SSI encoder frame. Only the least significant part of the total SSI encoder frame is valid. The complementary most significant part of the frame is ignored and read as 0.
	Monoflop check	High level Low level Ignore	High level	Data line level is verified before starting data emission (see description below).

For further generic descriptions, refer to I/O Configuration Tab Description ([see page 26](#)).

Monoflop Check Parameter

The **Monoflop check** parameter is used to test the data line level before starting data transmission: the clock starts only if the data line level is equal to the specified level.

This level is programmable, you can choose to perform the test or not.

If you test the level, you can select its value (0 or 1) via the interface.

The data line level is verified from T_m after the last rising edge of the clock line

In the example 1, the **Monoflop check** parameter must be configured to high level. This ensures that the clock generation is postponed until the data line goes high.

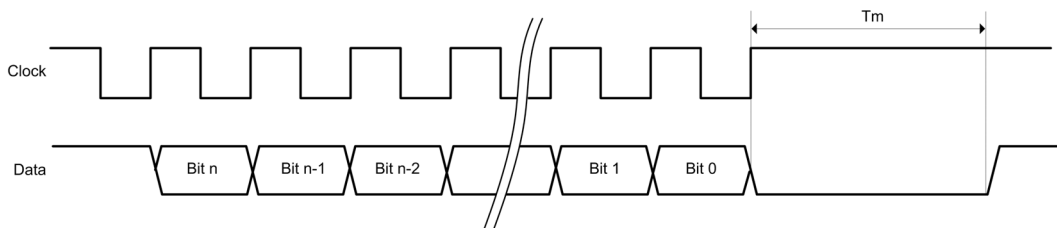

In the example 2 the **Monoflop check** parameter must be configured to low level. This ensures that the clock generation is postponed until the data line goes low.

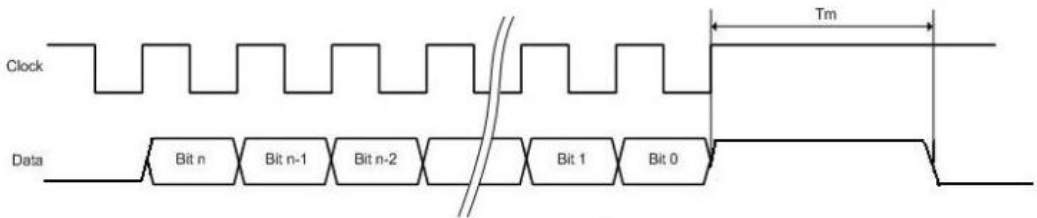

I/O Mapping Tab

Variables can be defined and named in the **I/O Mapping** tab. Additional information such as topological addressing is also provided in this tab.

This table describes the **I/O Mapping**:

Variable	Channel	Type	Default Value	Description	
Inputs	PowerSupply	USINT	-	Status encoder supply (bits 2...7: not used)	
	PowerSupply00	BOOL	-	Status encoder supply 24 Vdc (0=OK)	
	PowerSupply01	BOOL	-	Status encoder supply 5 Vdc (0=OK)	
	DigitalInput	USINT	-	State of all digital inputs (bits 0...3, 6-7: not used)	
	Reserved	BOOL	-	Not used	
	...				
	Reserved				
	DigitalInput00				State of digital input 0
	DigitalInput01				State of digital input 1
	Encoder00	UDINT	-	Encoder position value	

For further generic descriptions, refer to I/O Mapping Tab Description ([see page 26](#)).

Cycle Time and I/O Update Time

This table gives the module characteristics allowing the TM5 Bus Cycle Time configuration:

Characteristic	Value
Minimum cycle time	128 µs
Maximum cycle time	16 ms
Minimum I/O update time	128 µs

For further information, refer to TM5 Manager Configuration ([see page 23](#)).

Chapter 7

TM5 Transmitter - Receiver Electronic Modules

Introduction

This chapter provides information to configure transmitter - receiver expansion electronic modules.

To add expansion electronic modules and access to the configuration screens, refer to Adding an expansion electronic module ([see page 26](#)).

What Is in This Chapter?

This chapter contains the following topics:

Topic	Page
TM5SBET1	174
TM5SBET7	176
TM5SBER2	178

TM5SBET1

Introduction

The TM5SBET1 expansion electronic module is a Transmitter electronic module which transmits the TM5 data bus

For further information, refer to TM5SBET1 Transmitter Electronic Module (see *Modicon TM5, Transmitter and Receiver Modules, Hardware Guide*).

I/O Configuration Tab

To configure the TM5SBET1 electronic module, select the **I/O configuration** tab.

This table describes the modules parameters configuration:

Parameter		Value	Default Value	Description
General	Module address	0...250	Depends on the configuration	The address is automatically set when adding the modules. The address value depends on the order of adding the module in the SoMachine tree. The TM5ACBM15 supports the possibility to change the address.
	Module status information	On Off	On	Enable/Disable the read of the module information On: the StatusInputs word is added to the I/O Mapping tab.
	Voltage information	Off On	Off	Enable/Disable the read of the additional current/voltage information On: the SupplyVoltage word is added to the I/O Mapping tab.
	Bus base	TM5ACBM11 TM5ACBM15	TM5ACBM11	Specifies the bus base associated with the electronic module.
	Terminal block	TM5ACTB06 TM5ACTB12	TM5ACTB06	Specifies the terminal block associated with the electronic module.

For further generic descriptions, refer to I/O Configuration Tab Description (see [page 26](#)).

I/O Mapping Tab

Variables can be defined and named in the **I/O Mapping** tab. Additional information such as topological addressing is also provided in this tab.

This table describes the I/O Mapping:

Variable	Channel	Type	Default Value	Description
Inputs	StatusInputs	USINT	-	Status of the module (bits 2...7: not used)
	StatusInput00	BOOL	-	Bus power supply warning: <ul style="list-style-type: none"> ● 0 = OK ● 1 = low voltage <4.7 V
	Not used			Not used (bit=0)
	StatusInput01			I/O power supply warning: <ul style="list-style-type: none"> ● 0 = OK ● 1 = I/O power supply < 20.4 V
Supply/Voltage	USINT	-	Bus voltage with a resolution of 0.1 V	

For further generic descriptions, refer to I/O Mapping Tab Description ([see page 26](#)).

Cycle Time and I/O Update Time

This table gives the module characteristics allowing the TM5 Bus Cycle Time configuration:

Characteristic	Value (µs)
Minimum cycle time	100
Minimum I/O update time	2000

For further information, refer to TM5 Manager Configuration ([see page 23](#)).

TM5SBET7

Introduction

The TM5SBET7 expansion electronic module is a Transmitter electronic module which transmits the TM7 data bus and provides the TM7 power bus to the TM7 expansion I/O blocks.

For further information, refer to TM5SBET7 Transmitter Electronic Module (see *Modicon TM5, Transmitter and Receiver Modules, Hardware Guide*).

I/O Configuration Tab

To configure the TM5SBET7 electronic module, select the **I/O configuration** tab.

This table describes the modules parameters configuration:

Parameter		Value	Default Value	Description
General	Module address	0...250	0	The address is automatically set when adding the modules. The address value depends on the order of adding the module in the SoMachine tree. The TM5ACBM15 supports the possibility to change the address.
	Module status information	On Off	On	Enable/Disable the read of the module information On: the StatusInputs word is added to the I/O Mapping tab.
	Current/ Voltage information	Off On	Off	Enable/Disable the read of the additional current/voltage information On: the SupplyVoltage and SupplyCurrent words are added to the I/O Mapping tab.
	Bus base	TM5ACBM11 TM5ACBM15	TM5ACBM11	Specifies the bus base associated with the electronic module.
	Terminal block	TM5ACTB12	TM5ACTB12	Specifies the terminal block associated with the electronic module.

For further generic descriptions, refer to I/O Configuration Tab Description (see page 26).

I/O Mapping Tab

Variables can be defined and named in the **I/O Mapping** tab. Additional information such as topological addressing is also provided in this tab.

This table describes the I/O Mapping:

Variable	Channel	Type	Default value	Description
Inputs	StatusInputs	USINT	-	Status of the module (bits 2..7: not used)
	StatusInput00	BOOL	-	Bus power supply warning: <ul style="list-style-type: none"> ● 0 = OK ● 1 = over current > 0.4 A or low voltage <18 V
	Not used			Not used (bit=0)
	StatusInput01			I/O power supply warning: <ul style="list-style-type: none"> ● 0 = OK ● 1 = I/O power supply < 20.4 V
	SupplyCurrent	USINT	-	Bus current with a resolution of 0.01 A
	SupplyVoltage	USINT	-	Bus voltage with a resolution of 0.1 V

For further generic descriptions, refer to I/O Mapping Tab Description ([see page 26](#)).

Cycle Time and I/O Update Time

This table gives the module characteristics allowing the TM5 Bus Cycle Time configuration:

Characteristic	Value (µs)
Minimum cycle time	100
Minimum I/O update time	2000

For further information, refer to TM5 Manager Configuration ([see page 23](#)).

TM5SBER2

Introduction

The TM5SBER2 expansion electronic module is a Receiver electronic module which receives the TM5 data bus.

For further information, refer to TM5SBER2 Receiver Electronic Module (see *Modicon TM5, Transmitter and Receiver Modules, Hardware Guide*).

I/O Configuration Tab

To configure the TM5SBER2 electronic module, select the **I/O configuration** tab.

This table describes the modules parameters configuration:

Parameter		Value	Default Value	Description
General	Module address	0..250	Depends on the configuration	The address is automatically set when adding the modules. The address value depends on the order of adding the module in the SoMachine tree. The TM5ACBM15 supports the possibility to change the address.
	Module status information	On Off	On	Enable/Disable the read of the module information On: the StatusInputs word is added to the I/O Mapping tab.
	Current/Voltage information	Off On	Off	Enable/Disable the read of the additional current/voltage information On: the SupplyCurrent and SupplyVoltage words are added to the I/O Mapping tab.
	Bus base	TM5ACBM01R TM5ACBM05R	TM5ACBM01R	Specifies the bus base associated with the electronic module.
	Terminal block	TM5ACTB12PS	TM5ACTB12PS	Specifies the terminal block associated with the electronic module.

For further generic descriptions, refer to I/O Configuration Tab Description (see [page 26](#)).

I/O Mapping Tab

Variables can be defined and named in the **I/O Mapping** tab. Additional information such as topological addressing is also provided in this tab.

This table describes the I/O Mapping:

Variable	Channel	Type	Default Value	Description
Inputs	StatusInputs	USINT	-	Status of the module (bits 3..7: not used)
	StatusInput00	BOOL	-	Bus power supply warning: <ul style="list-style-type: none"> ● 0 = OK ● 1 = over current >2.3 A or low voltage <4.7 V
	Not used			Not used (bit=0)
	StatusInput01			I/O power supply warning: <ul style="list-style-type: none"> ● 0 = OK ● 1 = I/O power supply < 20.4 V
	SupplyCurrent	USINT	-	Bus current with a resolution of 0.1 A
	SupplyVoltage	USINT	-	Bus voltage with a resolution of 0.1 V

For further generic descriptions, refer to I/O Mapping Tab Description ([see page 26](#)).

Cycle Time and I/O Update Time

This table gives the module characteristics allowing the TM5 Bus Cycle Time configuration:

Characteristic	Value (µs)
Minimum cycle time	100
Minimum I/O update time	2000

For further information, refer to TM5 Manager Configuration ([see page 23](#)).

Chapter 8

TM5 Power Supply Electronic Modules

Introduction

This chapter provides information to configure power supply expansion electronic modules.

To add expansion electronic modules and access to the configuration screens, refer to Adding an expansion electronic module ([see page 26](#)).

What Is in This Chapter?

This chapter contains the following topics:

Topic	Page
TM5SPS1	182
TM5SPS1F	184
TM5SPS2	186
TM5SPS2F	188

TM5SPS1

Introduction

The TM5SPS1 expansion electronic module is a 24 Vdc power supply electronic module for internal I/O supply.

I/O Configuration Tab

To configure the TM5SPS1 electronic module, select the **I/O configuration** tab.

This table describes the modules parameters configuration:

Parameter	Value	Default Value	Description
General			
Module address	0...250	Depends on the configuration.	Specifies the electronic module address (only with TM5ACBM05R).
Module status information	On Off	On	Additional status information On: the StatusInputs word is added to the I/O Mapping tab.
Voltage information	Off On	Off	Additional current/voltage information On: the SupplyVoltage word is added to the I/O Mapping tab.
Bus base	TM5ACBM01R TM5ACBM05R	TM5ACBM01R	Specifies the bus base associated with the electronic module.
Terminal block	TM5ACTB12PS	TM5ACTB12PS	Specifies the terminal block associated with the electronic module.

For further generic descriptions, refer to I/O Configuration Tab Description ([see page 26](#)).

I/O Mapping Tab

Variables can be defined and named in the **I/O Mapping** tab. Additional information such as topological addressing is also provided in this tab.

This table describes the I/O Mapping:

Variable	Channel	Type	Default Value	Description
Inputs	StatusInputs	USINT	-	Status of the module (bits 3..7: not used)
	StatusInput00	BOOL	-	Bus power supply warning: <ul style="list-style-type: none"> ● 0 = OK ● 1 = low voltage <4.7 V
	Not used			Not used (bit=0)
	StatusInput01			I/O power supply warning: <ul style="list-style-type: none"> ● 0 = OK ● 1 = I/O power supply < 20.4 V
	SupplyVoltage	USINT	-	Bus voltage with a resolution of 0.1 V

For further generic descriptions, refer to I/O Mapping Tab Description ([see page 26](#)).

Cycle Time and I/O Update Time

This table gives the module characteristics allowing the TM5 Bus Cycle Time configuration:

Characteristic	Value (µs)
Minimum Cycle Time	100
Minimum I/O update time	2000

For further information, refer to TM5 Manager Configuration ([see page 23](#)).

TM5SPS1F

Introduction

The TM5SPS1F expansion electronic module is a 24 Vdc power supply electronic module for internal I/O supply with a fuse.

I/O Configuration Tab

To configure the TM5SPS1F electronic module, select the **I/O configuration** tab.

This table describes the modules parameters configuration:

Parameter		Value	Default Value	Description
General	Module address	0...250	Depends on the configuration	Specifies the electronic module address (only with TM5ACBM05R).
	Module status information	On Off	On	Additional status information On: the StatusInputs word is added to the I/O Mapping tab.
	Voltage information	Off On	Off	Additional voltage information On: the SupplyVoltage word is added to the I/O Mapping tab.
	Bus base	TM5ACBM01R TM5ACBM05R	TM5ACBM01R	Specifies the bus base associated with the electronic module.
	Terminal block	TM5ACTB12PS	TM5ACTB12PS	Specifies the terminal block associated with the electronic module.

For further generic descriptions, refer to I/O Configuration Tab Description ([see page 26](#)).

I/O Mapping Tab

Variables can be defined and named in the **I/O Mapping** tab. Additional information such as topological addressing is also provided in this tab.

This table describes the I/O Mapping:

Variable	Channel	Type	Default Value	Description
Inputs	StatusInputs	USINT	-	Status of the module (bits 3..7: not used)
	StatusInput00	BOOL	-	Bus power supply warning: <ul style="list-style-type: none"> ● 0 = OK ● 1 = low voltage <4.7 V
	StatusInput01			Fuse status: <ul style="list-style-type: none"> ● 0 = OK ● 1 = fuse is blown or missing
	StatusInput02			I/O power supply warning: <ul style="list-style-type: none"> ● 0 = OK ● 1 = I/O power supply < 20.4 V
SupplyVoltage	USINT	-	Bus voltage with a resolution of 0.1 V	

For further generic descriptions, refer to I/O Mapping Tab Description ([see page 26](#)).

Cycle Time and I/O Update Time

This table gives the module characteristics allowing the TM5 Bus Cycle Time configuration:

Characteristic	Value (µs)
Minimum Cycle Time	100
Minimum I/O update time	2000

For further information, refer to TM5 Manager Configuration ([see page 23](#)).

TM5SPS2

Introduction

The TM5SPS2 expansion electronic module is a 24 Vdc power supply electronic module for internal I/O supply.

I/O Configuration Tab

To configure the TM5SPS2 electronic module, select the **I/O configuration** tab.

This table describes the modules parameters configuration:

Parameter	Value	Default Value	Description	
General	Module address	0...250	Depends on the configuration	Specifies the electronic module address (only with TM5ACBM05R).
	Module status information	On Off	On	Additional status information On: the StatusInputs word is added to the I/O Mapping tab.
	Current/voltage information	Off On	Off	Additional current/voltage information On: the SupplyCurrent and SupplyVoltage words are added to the I/O Mapping tab.
	Bus base	TM5ACBM01R TM5ACBM05R	TM5ACBM01R	Specifies the bus base associated with the electronic module.
	Terminal block	TM5ACTB12PS	TM5ACTB12PS	Specifies the terminal block associated with the electronic module.

For further generic descriptions, refer to I/O Configuration Tab Description ([see page 26](#)).

I/O Mapping Tab

Variables can be defined and named in the **I/O Mapping** tab. Additional information such as topological addressing is also provided in this tab.

This table describes the I/O Mapping:

Variable	Channel	Type	Default Value	Description
Inputs	StatusInputs	USINT	-	Status of the module (bits 3...7: not used)
	StatusInput00	BOOL	-	Bus power supply warning: <ul style="list-style-type: none"> ● 0 = OK ● 1 = over current > 2.3 A or low voltage < 4.7 V
	Not used			-
	StatusInput01			I/O power supply warning: <ul style="list-style-type: none"> ● 0 = OK ● 1 = I/O power supply < 20.4 V
	SupplyCurrent	USINT	-	Bus current with a resolution of 0.1 A
	SupplyVoltage	USINT	-	Bus voltage with a resolution of 0.1 V

For further generic descriptions, refer to I/O Mapping Tab Description ([see page 26](#)).

Cycle Time and I/O Update Time

This table gives the module characteristics allowing the TM5 Bus Cycle Time configuration:

Characteristic	Value (µs)
Minimum cycle time	100
Minimum I/O update time	2000

For further information, refer to TM5 Manager Configuration ([see page 23](#)).

TM5SPS2F

Introduction

The TM5SPS2F expansion electronic module is a 24 Vdc power supply electronic module for internal I/O supply with a fuse.

I/O Configuration Tab

To configure the TM5SPS2F electronic module, select the **I/O configuration** tab.

This table describes the modules parameters configuration:

Parameter	Value	Default Value	Description	
General	Module address	0...250	Depends on the configuration Specifies the electronic module address (only with TM5ACBM05R).	
	Module status information	On Off	On Additional status information On: the StatusInputs word is added to the I/O Mapping tab.	
	Current/voltage information	Off On	Off Additional current/voltage information On: the SupplyCurrent and SupplyVoltage words are added to the I/O Mapping tab.	
	Bus base	TM5ACBM01R TM5ACBM05R	TM5ACBM01R	Specifies the bus base associated with the electronic module.
	Terminal block	TM5ACTB12PS	TM5ACTB12PS	Specifies the terminal block associated with the electronic module.

For further generic descriptions, refer to I/O Configuration Tab Description ([see page 26](#)).

I/O Mapping Tab

Variables can be defined and named in the **I/O Mapping** tab. Additional information such as topological addressing is also provided in this tab.

This table describes the I/O Mapping:

Variable	Channel	Type	Default Value	Description
Inputs	StatusInputs	USINT	-	Status of the module (bits 3..7: not used)
	StatusInput00	BOOL	-	Bus power supply warning: <ul style="list-style-type: none"> ● 0 = OK ● 1 = over current > 2.3 A or low voltage < 4.7 V
	Not used			-
	StatusInput01			I/O power supply warning: <ul style="list-style-type: none"> ● 0 = OK ● 1 = I/O power supply < 20.4 V
	SupplyCurrent	USINT	-	Bus current with a resolution of 0.1 A
	SupplyVoltage	USINT	-	Bus voltage with a resolution of 0.1 V

For further generic descriptions, refer to I/O Mapping Tab Description ([see page 26](#)).

Cycle Time and I/O Update Time

This table gives the module characteristics allowing the TM5 Bus Cycle Time configuration:

Characteristic	Value (µs)
Minimum cycle time	100
Minimum I/O update time	2000

For further information, refer to TM5 Manager Configuration ([see page 23](#)).

Chapter 9

TM5 Common Distribution Electronic Modules

Introduction

This chapter provides information to configure common distribution expansion electronic modules.

To add expansion electronic modules and access to the configuration screens, refer to Adding an expansion electronic module ([see page 26](#)).

What Is in This Chapter?

This chapter contains the following topics:

Topic	Page
TM5SPDG12F	192
TM5SPDD12F	194
TM5SPDG5D4F	196
TM5SPDG6D6F	198
TM5SD000	200

TM5SPDG12F

Introduction

The TM5SPDG12F expansion electronic module is a 12 x Ground potential distribution electronic module with a fuse.

I/O Configuration Tab

To configure the TM5SPDG12F electronic module, select the **I/O configuration** tab.

This table describes the modules parameters configuration:

Parameter		Value	Default Value	Description
General	Module address	0...250	Depends on the configuration	Specifies the electronic module address (only with TM5ACBM15).
	Bus base	TM5ACBM11 TM5ACBM15	TM5ACBM11	Specifies the bus base associated with the electronic module.
	Terminal block	TM5ACTB12	TM5ACTB12	Specifies the terminal block associated with the electronic module.
	24 V I/O segment external current	0...6300	0 mA	24 V I/O segment external current on TM5 power supply bus. Refer to System Planning and Installation Guide.

For further generic descriptions, refer to I/O Configuration Tab Description ([see page 26](#)).

I/O Mapping Tab

Variables can be defined and named in the **I/O Mapping** tab. Additional information such as topological addressing is also provided in this tab.

This table describes the I/O Mapping:

Variable	Channel	Type	Description
Inputs	StatusInputs	USINT	Status of the module (bits 1...7: not used)
	StatusFuse	BOOL	Fuse status: <ul style="list-style-type: none"> ● 0 = OK ● 1 = fuse is blown or missing

For further generic descriptions, refer to I/O Mapping Tab Description ([see page 26](#)).

Cycle Time and I/O Update Time

This table gives the module characteristics allowing the TM5 Bus Cycle Time configuration:

Characteristic	Value (μs)
Minimum cycle time	100
Minimum I/O update time	100

For further information, refer to TM5 Manager Configuration ([see page 23](#)).

TM5SPDD12F

Introduction

The TM5SPDD12F expansion electronic module is a 12 x 24 Vdc potential distribution electronic module with a fuse.

I/O Configuration Tab

To configure the TM5SPDD12F electronic module, select the **I/O configuration** tab.

This table describes the modules parameters configuration:

Parameter		Value	Default Value	Description
General	Module address	0...250	Depends on the configuration	Specifies the electronic module address (only with TM5ACBM15).
	Bus base	TM5ACBM11 TM5ACBM15	TM5ACBM11	Specifies the bus base associated with the electronic module.
	Terminal block	TM5ACTB12	TM5ACTB12	Specifies the terminal block associated with the electronic module.
	24 V I/O segment external current	0...6300	0 mA	24 V I/O segment external current on TM5 power supply bus. Refer to System Planning and Installation Guide.

For further generic descriptions, refer to I/O Configuration Tab Description ([see page 26](#)).

I/O Mapping Tab

Variables can be defined and named in the **I/O Mapping** tab. Additional information such as topological addressing is also provided in this tab.

This table describes the I/O Mapping:

Variable	Channel	Type	Description
Inputs	StatusInputs	USINT	Status of the module (bits 1...7: not used)
	StatusFuse	BOOL	Fuse status: <ul style="list-style-type: none"> ● 0 = OK ● 1 = fuse is blown or missing

For further generic descriptions, refer to I/O Mapping Tab Description ([see page 26](#)).

Cycle Time and I/O Update Time

This table gives the module characteristics allowing the TM5 Bus Cycle Time configuration:

Characteristic	Value (µs)
Minimum cycle time	100
Minimum I/O update time	100

For further information, refer to TM5 Manager Configuration ([see page 23](#)).

TM5SPDG5D4F

Introduction

The TM5SPDG5D4F expansion electronic module is a 12 x 24 Vdc potential distribution electronic module with a fuse.

I/O Configuration Tab

To configure the TM5SPDG5D4F electronic module, select the **I/O configuration** tab.

This table describes the modules parameters configuration:

Parameter		Value	Default Value	Description
General	Module address	0...250	Depends on the configuration	Specifies the electronic module address (only with TM5ACBM15).
	Edge counter	Off On	Off	Falling edge counter for power supply On: the Counter00 word is added to the I/O Mapping tab.
	Bus base	TM5ACBM11 TM5ACBM15	TM5ACBM11	Specifies the bus base associated with the electronic module.
	Terminal block	TM5ACTB12	TM5ACTB12	Specifies the terminal block associated with the electronic module.
	24 V I/O segment external current	0...6300	0 mA	24 V I/O segment external current on TM5 power supply bus. Refer to System Planning and Installation Guide.

For further generic descriptions, refer to I/O Configuration Tab Description ([see page 26](#)).

I/O Mapping Tab

Variables can be defined and named in the **I/O Mapping** tab. Additional information such as topological addressing is also provided in this tab.

This table describes the I/O Mapping:

Variable	Channel	Type	Description
Inputs	StatusInputs	USINT	Status of the module (bits 2...7: not used)
	StatusFuse	BOOL	Fuse status: <ul style="list-style-type: none"> ● 0 = OK ● 1 = fuse is blown or missing
	StatusPowerSupply		I/O power supply warning: <ul style="list-style-type: none"> ● 0 = OK ● 1 = I/O power supply < 20.4 V
	Counter00	USINT	Number of falling edges of power supply

For further generic descriptions, refer to I/O Mapping Tab Description ([see page 26](#)).

Cycle Time and I/O Update Time

This table gives the module characteristics allowing the TM5 Bus Cycle Time configuration:

Characteristic	Value (µs)
Minimum Cycle Time	100
Minimum I/O update time	100

For further information, refer to TM5 Manager Configuration ([see page 23](#)).

TM5SPDG6D6F

Introduction

The TM5SPDG6D6F expansion electronic module is a 6 x Ground and 6 x 24 Vdc potential distribution electronic module with a fuse.

I/O Configuration Tab

To configure the TM5SPDG6D6F electronic module, select the **I/O configuration** tab.

This table describes the modules parameters configuration:

Parameter		Value	Default Value	Description
General	Module address	0...250	Depends on the configuration	Specifies the electronic module address (only with TM5ACBM15).
	Edge counter	Off On	Off	Falling edge counter for power supply On: the Counter00 word is added to the I/O Mapping tab.
	Bus base	TM5ACBM11 TM5ACBM15	TM5ACBM11	Specifies the bus base associated with the electronic module.
	Terminal block	TM5ACTB12	TM5ACTB12	Specifies the terminal block associated with the electronic module.
	24 V I/O segment external current	0...6300	0 mA	24 V I/O segment external current on TM5 power supply bus. Refer to System Planning and Installation Guide.

For further generic descriptions, refer to I/O Configuration Tab Description ([see page 26](#)).

I/O Mapping Tab

Variables can be defined and named in the **I/O Mapping** tab. Additional information such as topological addressing is also provided in this tab.

This table describes the I/O Mapping:

Variable	Channel	Type	Description
Inputs	StatusInputs	USINT	Status of the module (bits 2...7: not used)
	StatusFuse	BOOL	Fuse status: <ul style="list-style-type: none"> ● 0 = OK ● 1 = fuse is blown or missing
	StatusPowerSupply		I/O power supply warning: <ul style="list-style-type: none"> ● 0 = OK ● 1 = I/O power supply < 20.4 V
	Counter00	USINT	Number of falling edges of power supply

For further generic descriptions, refer to I/O Mapping Tab Description ([see page 26](#)).

Cycle Time and I/O Update Time

This table gives the module characteristics allowing the TM5 Bus Cycle Time configuration:

Characteristic	Value (μ s)
Minimum cycle time	100
Minimum I/O update time	100

For further information, refer to TM5 Manager Configuration ([see page 23](#)).

TM5SD000

Introduction

The TM5SD000 expansion electronic module is a dummy electronic module.

I/O Configuration Tab

To configure the TM5SD000 electronic module, select the **I/O configuration** tab.

This table describes the modules parameters configuration:

Parameter		Value	Default Value	Description
General	Module address	0...250	Depends on the configuration	Specifies the electronic module address (only with TM5ACBM15).
	Bus base	TM5ACBM11 TM5ACBM12 TM5ACBM15	TM5ACBM11	Specifies the bus base associated with the electronic module.
	Terminal block	TM5ACTB06 TM5ACTB12 TM5ACTB32	TM5ACTB06	Specifies the terminal block associated with the electronic module.

For further generic descriptions, refer to I/O Configuration Tab Description ([see page 26](#)).



!

%I

According to the IEC standard, %I represents an input bit (for example, a language object of type digital IN).

%Q

According to the IEC standard, %Q represents an output bit (for example, a language object of type digital OUT).

A

ADC

(analog/digital converter)

analog input

Converts received voltage or current levels into numerical values. You can store and process these values within the logic controller.

analog output

Converts numerical values within the logic controller and sends out proportional voltage or current levels.

B

bus base

A mounting device that is designed to seat an electronic module on a DIN rail and connect it to the TM5 bus for M258 and LMC058 logic controllers. Each base bus extends the integrated TM5 data and electronic power buses as well as the 24 Vdc I/O power segment. The electronic modules are added to the TM5 system through their insertion on the base bus.

C

compact I/O module

An inseparable group of 5 analog and/or digital I/O electronic modules in a single reference.

configuration

The arrangement and interconnection of hardware components within a system and the hardware and software parameters that determine the operating characteristics of the system.

controller

Automates industrial processes (also known as programmable logic controller or programmable controller).

D

digital I/O

(*digital input/output*) An individual circuit connection at the electronic module that corresponds directly to a data table bit. The data table bit holds the value of the signal at the I/O circuit. It gives the control logic digital access to I/O values.

E

electronic module

In a programmable controller system, most electronic modules directly interface to the sensors, actuators, and external devices of the machine/process. This electronic module is the component that mounts in a bus base and provides electrical connections between the controller and the field devices. Electronic modules are offered in a variety of signal levels and capacities. (Some electronic modules are not I/O interfaces, including power distribution modules and transmitter/receiver modules.)

expansion bus

An electronic communication bus between expansion I/O modules and a controller.

F

firmware

Represents the BIOS, data parameters, and programming instructions that constitute the operating system on a controller. The firmware is stored in non-volatile memory within the controller.

flash memory

A non-volatile memory that can be overwritten. It is stored on a special EEPROM that can be erased and reprogrammed.

H**hex**

(*hexadecimal*)

I**I/O**

(*input/output*)

input filter

A special function that helps reject extraneous signals on input lines due to such things as contact bounce and inducted electrical transients. Inputs provide a level of input filtering using the hardware. Additional filtering with software is also configurable through the programming or the configuration software.

M**minimum I/O update time**

The time needed by the module or block to update I/O on the bus. If the bus cycle time is shorter than this minimum value, the I/O is updated on the bus at the next bus cycle time.

ms

(*millisecond*)

N**network**

A system of interconnected devices that share a common data path and protocol for communications.

P**PDM**

(*power distribution module*) A module that distributes either AC or DC field power to a cluster of I/O modules.

T

task

A group of sections and subroutines, executed cyclically or periodically for the MAST task or periodically for the FAST task.

A task possesses a level of priority and is linked to inputs and outputs of the controller. These I/O are refreshed in relation to the task.

A controller can have several tasks.

terminal block

(*terminal block*) The component that mounts in an electronic module and provides electrical connections between the controller and the field devices.

V

variable

A memory unit that is addressed and modified by a program.



0-9

12In, 15
2AO ± 10 V / 0-20 mA, 15
4AI ± 10 V, 15
4AI ± 10 V / 0-20 mA / 4-20 mA, 15
4AI 0-20 mA / 4-20 mA, 15
4AO ± 10 V, 15
4AO 0-20 mA, 15
4In, 15
4Out, 15
6In, 15
6Out, 15
6Rel, 15

A

analog I/O module
 TM5SAI2H, 112
 TM5SAI2L, 120
 TM5SAI2PH, 129
 TM5SAI2TH, 134
 TM5SAI4H, 112
 TM5SAI4L, 120
 TM5SAI4PH, 129
 TM5SAI6TH, 134
 TM5SAO2H, 141
 TM5SAO2L, 141
 TM5SAO4H, 144
 TM5SAO4L, 144
 TM5SEAISG, 148

C

common distribution module
 TM5SD000, 200
 TM5SPDD12F, 194
 TM5SPDG12F, 192
 TM5SPDG5D4F, 196
 TM5SPDG6D6F, 198

compact electronic module
 analog input 4AI, 64
 analog input 4AI ± 10 V, 62
 analog input 4AI 0-20 mA / 4-20 mA, 63
 analog output 2AO, 74
 analog output 4AO ± 10 V, 72
 analog output 4AO 0-20 mA, 73
 digital input 12In, 58
 digital input 4In, 56
 digital input 6In, 57
 digital output 4Out, 59
 digital output 6Out, 60
 digital output relay 6Rel, 61
compact I/O module
 TM5C12D6T6L, 39
 TM5C12D8T, 36
 TM5C2418T, 33
 TM5C24D12R, 43
 TM5CAI8O8VL, 46
configuring, 149

D

digital I/O module

- TM5SDI12D, 81
- TM5SDI16D, 83
- TM5SDI2A, 79
- TM5SDI2D, 76
- TM5SDI4A, 79
- TM5SDI4D, 76
- TM5SDI6D, 76
- TM5SDI6U, 79
- TM5SDM12DT, 99
- TM5SDO12T, 90
- TM5SDO16T, 90
- TM5SDO2R, 95
- TM5SDO2S, 97
- TM5SDO2T, 90
- TM5SDO4R, 95
- TM5SDO4T, 90
- TM5SDO4TA, 93
- TM5SDO6T, 90
- TM5SDO8TA, 93

E

expansion modules

- add, 26
- general description, 16

expansion modules and blocks

- check resources, 23
- TM5 manager, 23

expert I/O module

- TM5SDI2DF, 85
- TM5SE1IC01024, 162
- TM5SE1IC02505, 158
- TM5SE1SC10005, 170
- TM5SE2IC01024, 166

M

mixed I/O module

- TM5SMM6D2L, 101

P

power supply module

- TM5SPS1, 182
- TM5SPS1F, 184
- TM5SPS2, 186
- TM5SPS2F, 188

S

synchronous mode, 152

T

TM5, 15

TM5 analog, 15

TM5 common distribution, 15

TM5 compact, 15

TM5 digital, 15

TM5 expert, 15

TM5 power distribution, 15

TM5 receiver, 15

TM5 transmitter, 15

TM5C12D6T6L, 15

TM5C12D8T, 15

TM5C24D12R, 15

TM5C24D18T, 15

TM5CAI8O8CL, 15

TM5CAI8O8CVL, 15

TM5CAI8O8VL, 15

TM5SAI2H, 15

TM5SAI2L, 15

TM5SAI2PH, 15

TM5SAI2TH, 15

TM5SAI4H, 15

TM5SAI4L, 15

TM5SAI4PH, 15

TM5SAI6TH, 15

TM5SAO2H, 15

TM5SAO2L, 15

TM5SAO4H, 15

TM5SAO4L, 15

TM5SBER2, 15

TM5SBET1, 15

TM5SBET7, 15

TM5SD000, 15

TM5SDI12D, 15
TM5SDI2A, 15
TM5SDI2D, 15
TM5SDI2DF, 15
TM5SDI4A, 15
TM5SDI4D, 15
TM5SDI6D, 15
TM5SDI6U, 15
TM5SDM12DT, 15
TM5SDO12T, 15
TM5SDO2R, 15
TM5SDO2S, 15
TM5SDO2T, 15
TM5SDO4R, 15
TM5SDO4T, 15
TM5SDO4TA, 15
TM5SDO6T, 15
TM5SDO8TA, 15
TM5SE1IC01024, 15
TM5SE1IC02505, 15
TM5SE1SC10005, 15
TM5SEAISG, 15
TM5SMM6D2L, 15
TM5SPDD12F, 15
TM5SPDG12F, 15
TM5SPDG5D4F, 15
TM5SPDG6D6F, 15
TM5SPS1, 15
TM5SPS1F, 15
TM5SPS2, 15
TM5SPS2F, 15
transmitter/receiver module
 TM5SBER2, 178
 TM5SBET1, 174
 TM5SBET7, 176

