



WLG12-V537

WLG

SWITCHING AUTOMATION LIGHT GRIDS

SICK
Sensor Intelligence.



Illustration may differ



Ordering information

Type	Part no.
WLG12-V537	1016045

Other models and accessories → www.sick.com/WLG

Detailed technical data

Features

Sensor principle	Photoelectric retro-reflective sensor
Minimum detectable object (MDO)	Parallel beam, 6 mm ... 12.5 mm
Beam separation	12.5 mm
Number of beams	8
Detection height	87.5 mm
Resolution (adjustable)	6 mm ... 12.5 mm ¹⁾

¹⁾ Dependence of the range.

Mechanics/electronics

Wave length	650 nm
Supply voltage V_s	DC 18 V ... 30 V ¹⁾
Power consumption sender	80 mA
Ripple	< 5 V _{pp}
Output current I_{max}	≤ 100 mA
Output load, capacitive	100 nF
Output load, Inductive	1 H
Initialization time	0.6 s
Switching output	PNP ²⁾
Output mode	Q dark switching ³⁾
Teach-in input	PNP
Dimensions (W x H x D)	62 mm x 106 mm x 46.6 mm
Connection type	Male connector M12, 5-pin
Housing material	Plastic

¹⁾ Typical value.

²⁾ \bar{Q} .

³⁾ Q = active, if at least one beam is interrupted, /Q = active, if all of the beams are free.

Indication	LED
Enclosure rating	IP67
Circuit protection	U _V connections, reverse polarity protected Output Q short-circuit protected Interference pulse suppression
Protection class	II
Weight	230 g
Front screen	PMMA

¹⁾ Typical value.

²⁾ \dot{Q} .

³⁾ Q = active, if at least one beam is interrupted, /Q = active, if all of the beams are free.

Performance

Maximum range	1.5 m
Minimum range	≥ 100 mm
Operating range	1.5 m
Response time	Parallel beam, 0.6 ms ¹⁾

¹⁾ With resistive load.

Ambient data

Enclosure rating	IP67
Shock resistance	10 g / DIN EN 60068-2-29 / 16 ms
Vibration resistance	5 g, 10 Hz ... 55 Hz (IEC 68-2-6)
EMC	EN 60947-5-2
Ambient operating temperature	-25 °C ... +55 °C
Ambient temperature, storage	-20 °C ... +70 °C

Classifications

ECl@ss 5.0	27270910
ECl@ss 5.1.4	27270910
ECl@ss 6.0	27270910
ECl@ss 6.2	27270910
ECl@ss 7.0	27270910
ECl@ss 8.0	27270910
ECl@ss 8.1	27270910
ECl@ss 9.0	27270910
ECl@ss 10.0	27270910
ECl@ss 11.0	27270910
ETIM 5.0	EC002549
ETIM 6.0	EC002549
ETIM 7.0	EC002549
UNSPSC 16.0901	39121528

Dimensional drawing (Dimensions in mm (inch))

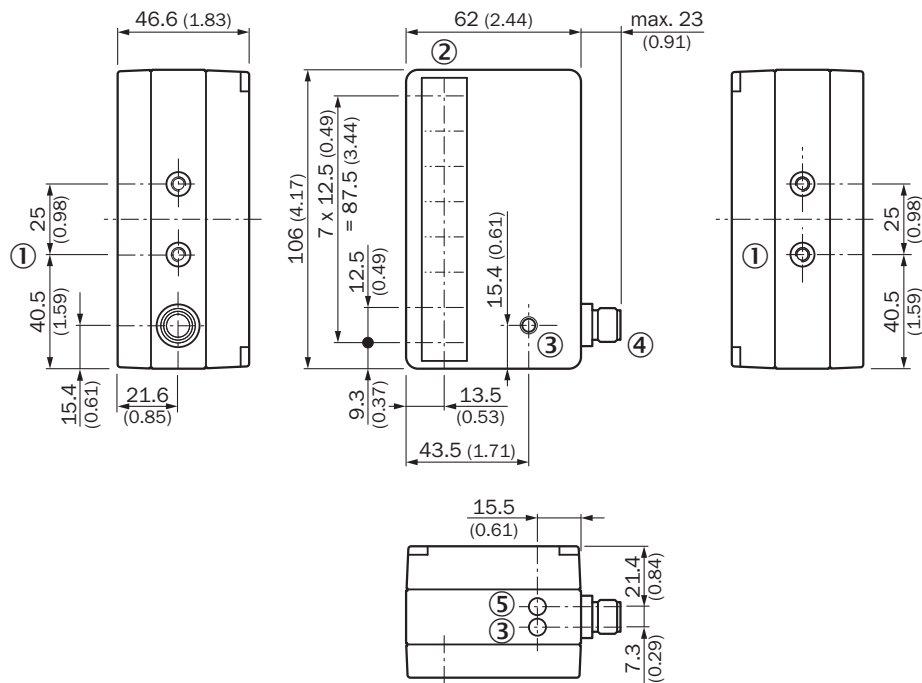

- ① M5 threaded mounting hole, 6 mm deep
- ② Optic
- ③ Multifunctional display front and top: receive indicator, output weak signal, error during teach-in
- ④ M12 male connector, 5-pin or 2 m cable
- ⑤ Operating indicator

Adjustments

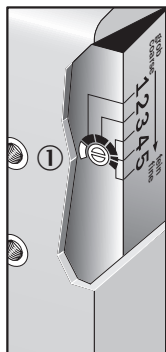

Choice of sensitivity range, dimensions in mm/m (inch)

Potentiometer setting	Resolution	Working range	Reflector
1	> 12.5 mm (0.49)	1.5 m (59.06)	2 x PL80A/PL40A
2	> 10 mm (0.39)	1.2 m (47.24)	2 x PL80A/PL40A
3	> 9 mm (0.35)	1.0 m (39.37)	PL180E01
4	> 7 mm (0.28)	0.8 m (31.50)	PL180E01
5	> 6 mm (0.24)	0.4 m (15.75)	PL180E01

- ① Potentiometer for sensitivity adjustment



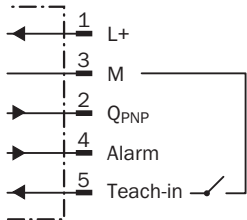
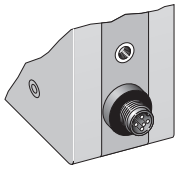

Connection type and diagram

Connection type and diagram



Recommended accessories

Other models and accessories → www.sick.com/WLG

	Brief description	Type	Part no.
Mounting brackets and plates			
	<ul style="list-style-type: none"> Description: Mounting bracket Material: Steel Items supplied: Mounting hardware included 	BEF-WN-WLG12	2017567
Plug connectors and cables			
	<ul style="list-style-type: none"> Connection type head A: Female connector, M12, 5-pin, angled, A-coded Connection type head B: Flying leads Authorizations: CE, UL Signal type: Sensor/actuator cable Cable: 5 m, 5-wire, PVC Description: Sensor/actuator cable, unshielded Application: Zones with chemicals 	YG2A15-050VB5XLEAX	2096216
	<ul style="list-style-type: none"> Connection type head A: Female connector, M12, 5-pin, straight Authorizations: UL Description: Unshielded, Head A: female connector, M12, 5-pin, straight, unshielded, for cable diameter 4 mm ... 6 mm Head B: - Connection systems: Screw-type terminals Permitted cross-section: ≤ 0.75 mm² 	DOS-1205-G	6009719
Reflectors			
	<ul style="list-style-type: none"> Description: Reflector, rectangular, screw connection Dimensions: 40 mm 180 mm Ambient operating temperature: -20 °C ... +65 °C 	PL180E01	1013289

SICK AT A GLANCE

SICK is one of the leading manufacturers of intelligent sensors and sensor solutions for industrial applications. A unique range of products and services creates the perfect basis for controlling processes securely and efficiently, protecting individuals from accidents and preventing damage to the environment.

We have extensive experience in a wide range of industries and understand their processes and requirements. With intelligent sensors, we can deliver exactly what our customers need. In application centers in Europe, Asia and North America, system solutions are tested and optimized in accordance with customer specifications. All this makes us a reliable supplier and development partner.

Comprehensive services complete our offering: SICK LifeTime Services provide support throughout the machine life cycle and ensure safety and productivity.

For us, that is “Sensor Intelligence.”

WORLDWIDE PRESENCE:

Contacts and other locations –www.sick.com