



Product designation				Power contactor
Product type designation				BF65
Contact characteristics				
Number of poles	Nr.			4
Rated insulation voltage U _i IEC/EN	V			1000
Rated impulse withstand voltage U _{imp}	kV			8
Operational frequency	min	Hz	25	
	max	Hz	400	
IEC Conventional free air thermal current I _{th}	A			100
Operational current I _e	AC-1 (≤40°C)	A	100	
	AC-1 (≤55°C)	A	80	
	AC-1 (≤70°C)	A	70	
	AC-3 (≤440V ≤55°C)	A	65	
	AC-4 (400V)	A	31	
Rated operational current AC-3 (T≤55°C)	230V	A	65	
	400V	A	65	
	415V	A	65	
	440V	A	65	
	500V	A	53	
	690V	A	47	
	1000V	A	25	
Rated operational power AC-1 (T≤40°C)	230V	kW	38	
	400V	kW	65	
	500V	kW	82	
	690V	kW	114	
IEC max current I _e in DC1 with L/R ≤ 1ms with 1 poles in series	≤24V	A	50	
	48V	A	50	
	75V	A	50	
	110V	A	8	
	220V	A	–	
IEC max current I _e in DC1 with L/R ≤ 1ms with 2 poles in series	≤24V	A	70	
	48V	A	70	
	75V	A	70	
	110V	A	60	
	220V	A	9	
IEC max current I _e in DC1 with L/R ≤ 1ms with 3 poles in series	≤24V	A	70	
	48V	A	70	
	75V	A	70	

	110V	A	60
	220V	A	90
<hr/>			
IEC max current I _e in DC1 with L/R ≤ 1ms with 4 poles in series			
	≤24V	A	70
	48V	A	70
	75V	A	70
	110V	A	70
	220V	A	110
<hr/>			
IEC max current I _e in DC3-DC5 with L/R ≤ 15ms with 1 poles in series			
	≤24V	A	35
	48V	A	25
	75V	A	25
	110V	A	3
	220V	A	–
<hr/>			
IEC max current I _e in DC3-DC5 with L/R ≤ 15ms with 2 poles in series			
	≤24V	A	45
	48V	A	40
	75V	A	40
	110V	A	30
	220V	A	5
<hr/>			
IEC max current I _e in DC3-DC5 with L/R ≤ 15ms with 3 poles in series			
	≤24V	A	55
	48V	A	50
	75V	A	50
	110V	A	35
	220V	A	52
<hr/>			
IEC max current I _e in DC3-DC5 with L/R ≤ 15ms with 4 poles in series			
	≤24V	A	60
	48V	A	60
	75V	A	60
	110V	A	50
	220V	A	65
<hr/>			
Short-time allowable current for 10s (IEC/EN60947-1)		A	640
<hr/>			
Protection fuse			
	gG (IEC)	A	125
	aM (IEC)	A	80
<hr/>			
Making capacity (RMS value)		A	650
<hr/>			
Breaking capacity at voltage			
	440V	A	520
	500V	A	425
	690V	A	376
<hr/>			
Resistance per pole (average value)		mΩ	0.8
<hr/>			
Power dissipation per pole (average value)			
	I _{th}	W	8
	AC-3	W	3.4
<hr/>			
Tightening torque for terminals			
	min	Nm	4
	max	Nm	5
	min	I _{bin}	2.95
	max	I _{bin}	3.69
<hr/>			
Tightening torque for coil terminal			
	min	Nm	0.8
	max	Nm	1

	min	I _{bin}	0.8
	max	I _{bin}	0.74
Max number of wires simultaneously connectable		Nr.	2
Conductor section			
AWG/Kcmil			
	max		2
Flexible w/o lug conductor section			
	min	mm ²	1.5
	max	mm ²	35
Flexible c/w lug conductor section			
	min	mm ²	1.5
	max	mm ²	35
Power terminal protection according to IEC/EN 60529			IP20 front
Mechanical features			
Operating position			
	normal allowable		Vertical plan ±30°
Fixing			Screw / DIN rail 35mm
Weight		g	1240
Conductor section			
AWG/kcmil conductor section			
	max		2
Operations			
Mechanical life		cycles	15000000
Electrical life		cycles	1400000
Safety related data			
Performance level B10d according to EN/ISO 13489-1			
	rated load	cycles	1400000
	mechanical load	cycles	15000000
Mirror contacts according to IEC/EN 60947-4-1			yes
EMC compatibility			yes
AC coil operating			
Rated AC voltage at 50/60Hz		V	24
AC operating voltage			
of 50/60Hz coil powered at 50Hz			
pick-up	min	%U _s	80
	max	%U _s	110
drop-out	min	%U _s	20
	max	%U _s	55
of 50/60Hz coil powered at 60Hz			
pick-up	min	%U _s	85
	max	%U _s	110
drop-out	min	%U _s	40
	max	%U _s	55
AC average coil consumption at 20°C			
of 50/60Hz coil powered at 50Hz			
	in-rush	VA	210
	holding	VA	15

of 50/60Hz coil powered at 60Hz

in-rush	VA	195
holding	VA	13

of 60Hz coil powered at 60Hz

in-rush	VA	210
holding	VA	15

Dissipation at holding $\leq 20^{\circ}\text{C}$ 50Hz

W	5
---	---

Max cycles frequency

Mechanical operation

cycles/h	3600
----------	------

Operating times

Average time for Us control

in AC

Closing NO

min	ms	12
max	ms	28

Opening NO

min	ms	8
max	ms	22

in DC

Closing NO

min	ms	40
max	ms	85

Opening NO

min	ms	20
max	ms	55

UL technical data

Full-load current (FLA) for three-phase AC motor

at 480V	A	65
at 600V	A	62

Yielded mechanical performance

for three-phase AC motor

200/208V	HP	20
220/230V	HP	25
460/480V	HP	50
575/600V	HP	60

General USE

Contactor

AC current	A	100
------------	---	-----

Short-circuit protection fuse, 600V

High fault

Short circuit current	kA	100
Fuse rating	A	200
Fuse class		J

Standard fault

Short circuit current	kA	10
Fuse rating	A	200
Fuse class		RK5

Ambient conditions

Temperature

Operating temperature

min	$^{\circ}\text{C}$	-50
max	$^{\circ}\text{C}$	70

Storage temperature

min	$^{\circ}\text{C}$	-60
-----	--------------------	-----

Max altitude	max	°C	80
		m	3000

Resistance & Protection

Pollution degree	3
------------------	---

Dimensions

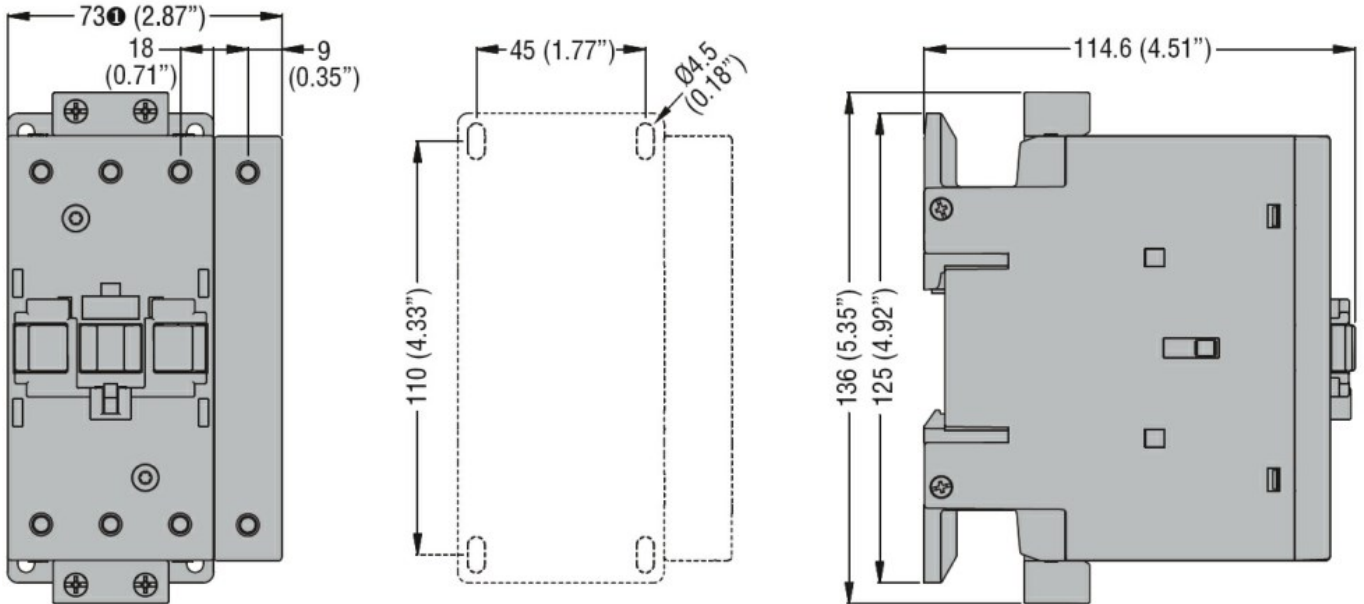

① BF80T2 82mm/3.23"

Wiring diagrams

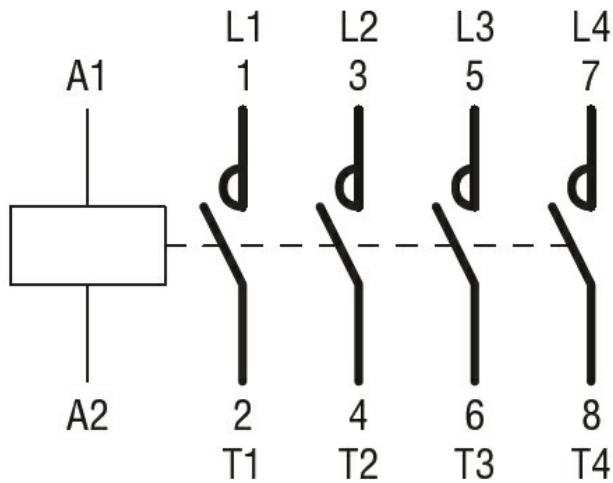

Certifications and compliance

Compliance	CSA C22.2 n° 60947-1
	CSA C22.2 n° 60947-4-1
	IEC/EN/BS 60947-1
	IEC/EN/BS 60947-4-1
	UL 60947-1
	UL 60947-4-1

Certificates	CCC
	cULus

ETIM classification

ETIM 8.0

EC000066 -
Power contactor,
AC switching