

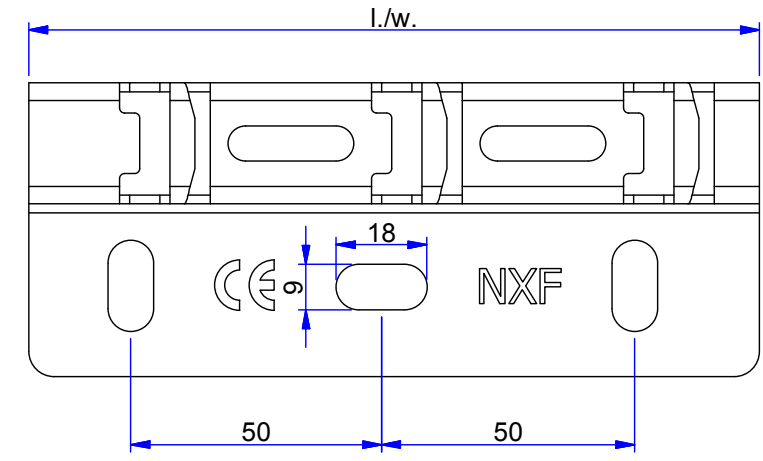

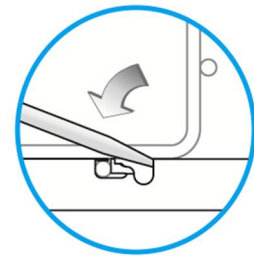

Chemin de câbles fil
(Mesh tray)

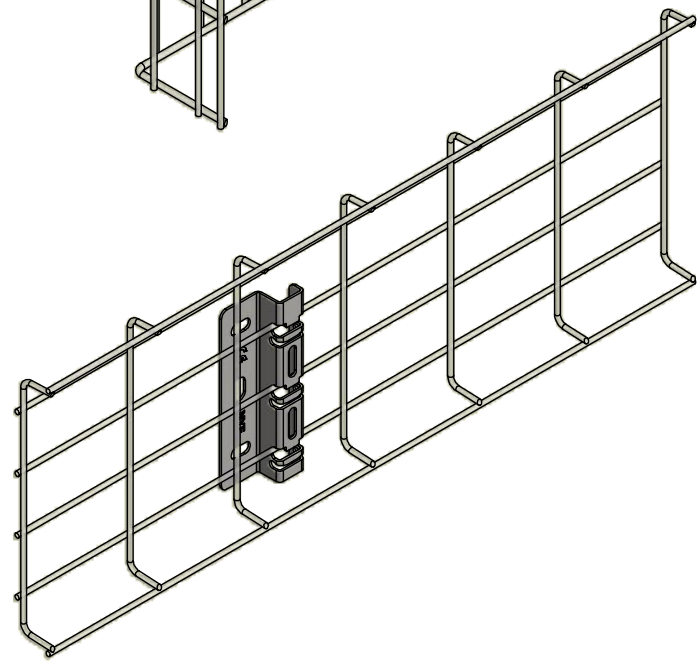
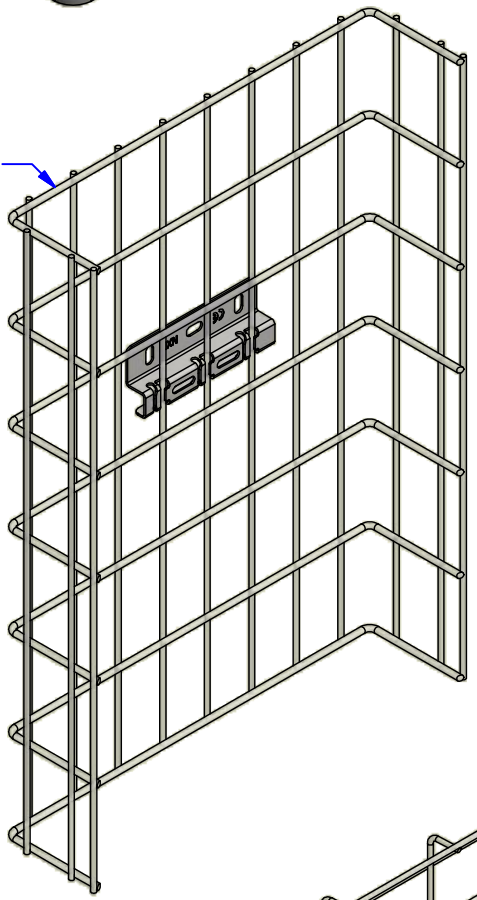

Description	Code	Masse/Weight Kg/p	Ep./Th. mm	H mm	l./w. mm
ZUF 150 U I3	555147	0,122	1,50	22	145

SS316L : Stainless steel according to NF EN 10088-2 (316L).
I3 : Tôle d'acier inoxydable suivant NF EN 10088-2 (316L).

 30 ▶ 105 mm
 50 ▶ 600 mm



www.niedaxfrance.fr

ZED FIXATION ZUF 150 U I3
 ZUF 150U CLIP-ON BRACKET SS316L



ASSISTANCE TECHNIQUE
 +33 (0)1 55 95 92 17
 pole.technique@niedax.fr

FT02884

NIEDAX
 France

