

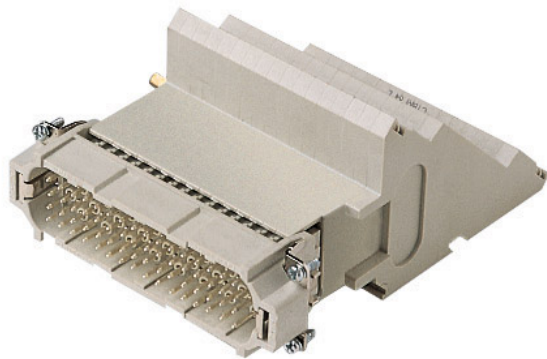

Part number

CTSM 64 R



Male insert, CTS series, spring terminal connection, 64 poles + PE, 10 A 250 V 4 kV 3, size "104.27", with incorporated terminal block, right side mounting

Product description

Product type	Insert
Series	CTS
Connection type	Spring terminal connection
Gender	Male
N. of poles	64 poles + 
Size	Size 104.27
Specification	Right side mounting With incorporated terminal block

Technical data

Current	10 A
Voltage	250 V
Rated impulse withstand voltage	4 kV
Pollution degree	3
Rated voltage according to UL/CSA	600 V
Wire cross-section	0,14 mm ² - 2,50 mm ²
AWG size	26 - 14
Contact type	Turned silver plated
IP degree of protection	IP20 without enclosure, IP66/IP69 with enclosure

Further technical details

Characteristics according to EN 61984	10A 250V 4kV 3; 10A 230/400V 4kV 2
Mating cycles	≥ 500
Insulation resistance	≥ 10 GΩ
Contact resistance	≤ 4 mΩ
Weight	541,50 g
Operating temperature range (min, max)	-40 °C ... +125 °C
UL 94 flammability rating	V-0

Material properties

Main material	Polycarbonate (PC)
Other materials	Contacts: copper alloy
Colour	RAL 7032 grey
RoHs conformity	Compliant with exemption 6(c): copper alloy containing up to 4% lead by weight
China RoHs - EFUP	50
REACH SVHC substances	Yes Lead
SCIP number	1a9c93ff-0445-4a16-81e3-1609ac5274d6

Approvals / Standards

Reference standard	EN 61984:2009-06
Certifications	CSAc, CQC, DNV, BV, EAC
UL	ECB22

General ordering information

EAN13 code	8015747041621
eCl@ss 8.1	27440205
ETIM 7.0	EC000438

Packaging Information

Sub-packaging length	145,00 mm
Sub-packaging height	89,00 mm
Sub-packaging width	120,00 mm
Sub-packaging weight	0,54 kg
Sub-packaging volume	1,55 dm ³
Sub-packaging description	Carton box
Sub-packaging quantity	1 Pcs
Sub-packaging EAN barcode	8015747041638

Part number

CTSM 64 R



Catalogue drawings

Catalogue drawings

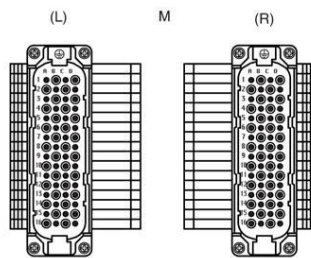
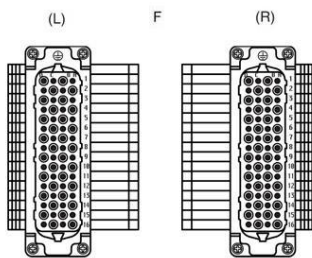
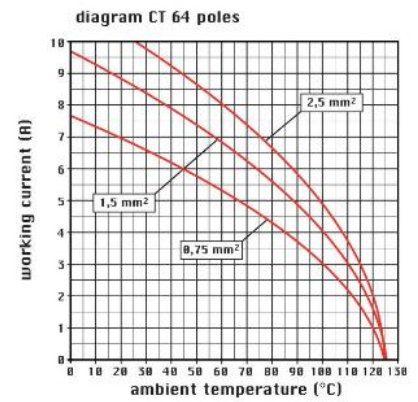
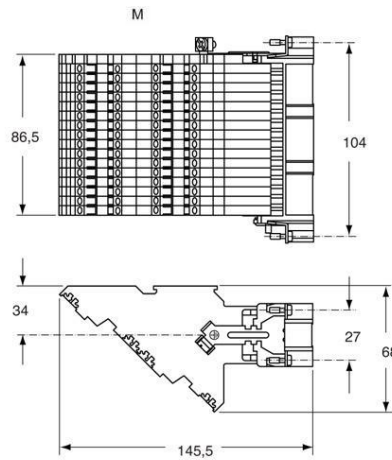
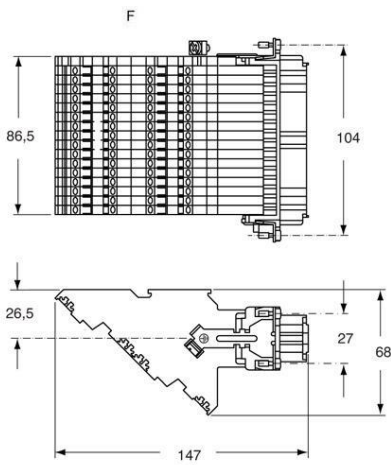

Notes

Dimensions shown in mm are not binding and may be changed without notice.

Spring terminal connection.

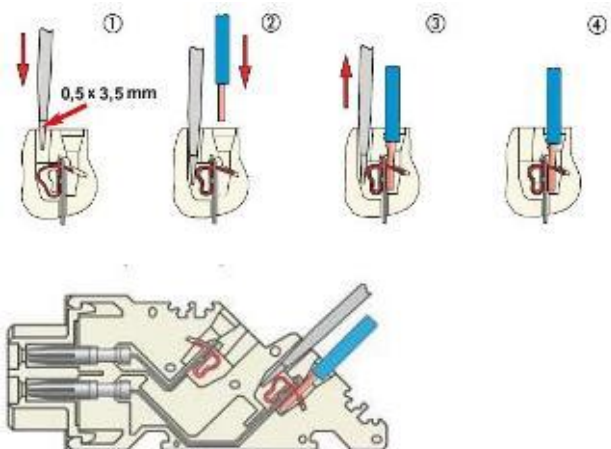

California Proposition 65 Information



WARNING

This product can expose you to lead and its compounds, known to the State of California to cause cancer and/or reproductive toxicity. For more information go to www.P65Warnings.ca.gov.

California Proposition 65 Information



WARNING

This product can expose you to lead and its compounds, known to the State of California to cause cancer and/or reproductive toxicity. For more information go to www.P65Warnings.ca.gov.
