



V3DX3-004BR21A

Ruler3000

3D MACHINE VISION

**SICK**  
Sensor Intelligence.



### Ordering information

Type	Part no.
V3DX3-004BR21A	1126984

Other models and accessories → [www.sick.com/Ruler3000](http://www.sick.com/Ruler3000)



**GiGE**  
VISION

**GEN<i>i>CAM**  
UK  
CA

### Detailed technical data

#### Features

<b>Task</b>	3D inspection Measuring, 3D
<b>Technology</b>	3D triangulation
<b>Product category</b>	Streaming, pre-calibrated
<b>Shutter technology</b>	Global-Shutter
<b>Working distance</b>	54.2 mm ... 71.8 mm
<b>Example field of view</b>	40 mm x 12 mm
<b>Exposure mode</b>	Linear HDR
<b>Illumination</b>	Integrated
<b>Illumination color</b>	Blue, laser, Visible, 450 nm, ± 10 nm
<b>Laser class</b>	3R (EN 60825-1:2014+A11:2021; IEC 60825-1:2014, Complies with the FDA performance requirements for laser products except for conformance with IEC 60825-1 Ed.3., as described in Laser Notice 56 dated May 8, 2019.)
<b>Data synchronization</b>	Free running, encoder triggered, external triggering
<b>Factory calibrated</b>	✓
<b>3D measurement</b>	✓
<b>Scatter measurement</b>	✓
<b>Reflectance measurement</b>	✓
<b>Ambient light suppression</b>	✓ <sup>1)</sup>
<b>Scheimpflug adapter, integrated</b>	✓

<sup>1)</sup> Blue bandpass filter.

<b>Width at minimum operating distance</b>	38 mm
<b>Width at maximum operating distance</b>	45 mm
<b>Maximum height range</b>	17.6 mm

<sup>1)</sup> Blue bandpass filter.

## Mechanics/electronics

<b>Connection type</b>	Voltage – I/O: M12, 17-pin male connector Gigabit Ethernet: M12, 8-pin female connector, X-coded
<b>Connector material</b>	M12: Nickel-coated brass
<b>Supply voltage</b>	24 V DC, ± 10 %
<b>Ripple</b>	< 5 V <sub>pp</sub>
<b>Power consumption</b>	≤ 12 W
<b>Current consumption</b>	≤ 1.5 A
<b>Enclosure rating</b>	IP65 IP67
<b>Protection class</b>	III
<b>Housing material</b>	Aluminum
<b>Housing color</b>	Blue
<b>Window material</b>	Float glass, anti-reflective coated
<b>Weight</b>	0.99 kg
<b>Dimensions (L x W x H)</b>	129.5 mm x 60.3 mm x 100 mm

## Performance

<b>Image sensor</b>	CMOS sensor from SICK with ROCC technology, M30
<b>Scan/frame rate</b>	46,000 3D profiles/s, In reduced ROI 7,000 3D profiles/s, full format
<b>Data points/profile</b>	3,200
<b>Repeatability</b>	0.5 μm <sup>1)</sup>
<b>Typical resolution</b>	Z resolution (height): 1.5 μm ... 2 μm, X resolution (width): 17 μm ... 20 μm

<sup>1)</sup> Height values measured for different positions in the field of view. 20 measurements are performed at each position. The repeatability value is the 3-fold of the standard deviation (3 σ) for all measurements at all positions.

## Interfaces

<b>Ethernet</b>	✓, UDP/IP
Data transmission rate	≤ 1 Gbit/s
<b>Configuration software</b>	Stream Setup
<b>Operating system</b>	Windows 10
<b>Programming interface</b>	GenAPI, GenTL, Proprietary SICK GenIStream
<b>Inputs/outputs</b>	4 x HIGH = 10 V ... 28.8 V, configurable
<b>Encoder interface</b>	RS-422 5 V, 2 x HTL single-ended

## Ambient data

<b>Shock load</b>	15 g, 3 cycles per axis
-------------------	-------------------------

<sup>1)</sup> Non-condensing.

<sup>2)</sup> Height values measured for different positions in the field of view. 20 measurements are performed at each position. The repeatability value is the 3-fold of the standard deviation (3 σ) for all measurements at all positions.

<b>Vibration load</b>	5 g, 10 Hz ... 150 Hz (EN 60068-2-6)
<b>Ambient operating temperature</b>	0 °C ... +40 °C <sup>1)</sup>
<b>Storage temperature</b>	-30 °C ... +70 °C <sup>1)</sup>
<b>Depth precision</b>	0.5 µm <sup>2)</sup>

<sup>1)</sup> Non-condensing.

<sup>2)</sup> Height values measured for different positions in the field of view. 20 measurements are performed at each position. The repeatability value is the 3-fold of the standard deviation (3 σ) for all measurements at all positions.

### Classifications

<b>ECLASS 5.0</b>	27310205
<b>ECLASS 5.1.4</b>	27310205
<b>ECLASS 6.0</b>	27310205
<b>ECLASS 6.2</b>	27310205
<b>ECLASS 7.0</b>	27310205
<b>ECLASS 8.0</b>	27310205
<b>ECLASS 8.1</b>	27310205
<b>ECLASS 9.0</b>	27310205
<b>ECLASS 10.0</b>	27310205
<b>ECLASS 11.0</b>	27310205
<b>ECLASS 12.0</b>	27310205
<b>ETIM 5.0</b>	EC001820
<b>ETIM 6.0</b>	EC001820
<b>ETIM 7.0</b>	EC001820
<b>ETIM 8.0</b>	EC001820
<b>UNSPSC 16.0901</b>	43211731

## Dimensional drawing (Dimensions in mm (inch))

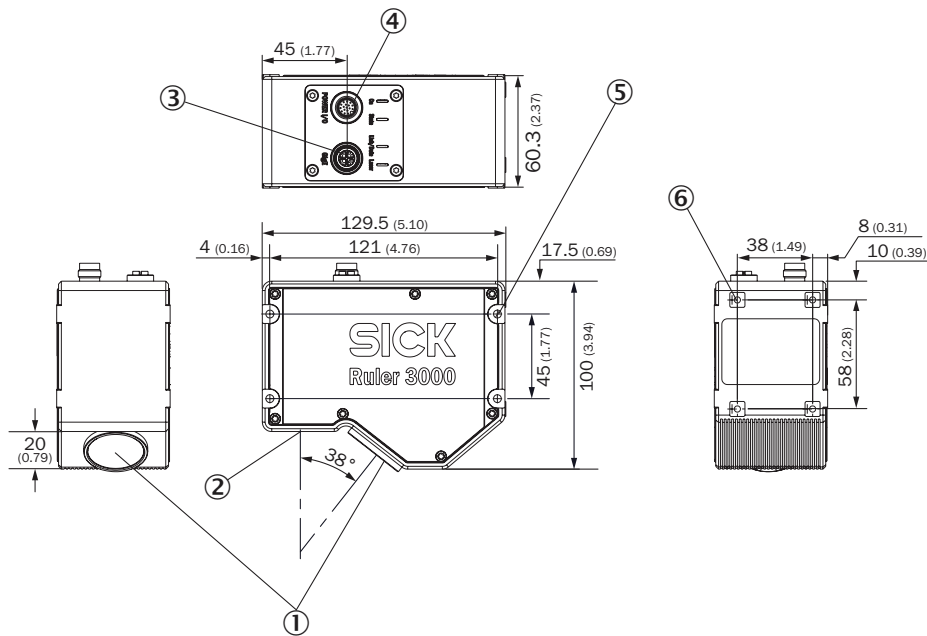

- ① Optical receiver (center)
- ② Optical sender (center)
- ③ Gigabit Ethernet (GigE) connection
- ④ Power/I/O connection
- ⑤ Threaded mounting hole M5
- ⑥ M5 threaded mounting hole, 10 mm deep

### Field of view

#### Ruler3004

Guaranteed field of view in mm

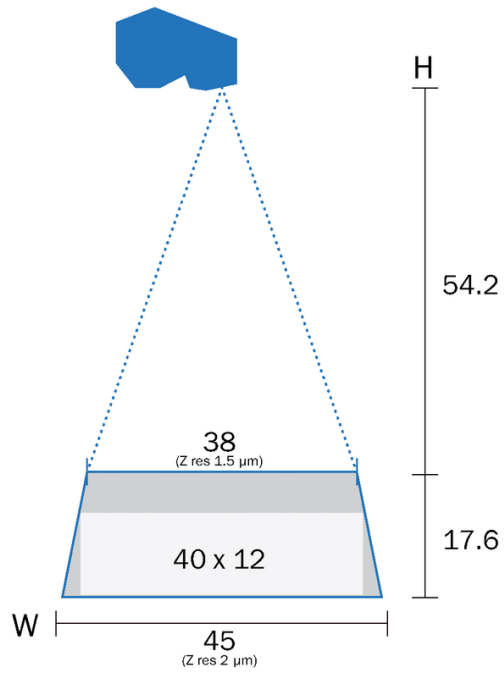

### Characteristic curve

Width of the field of view via the Z position

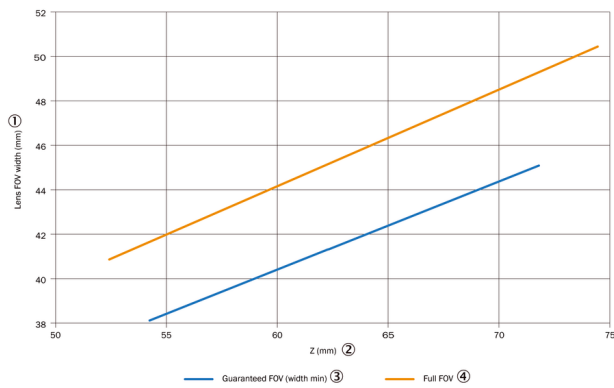

Z resolution via Z position

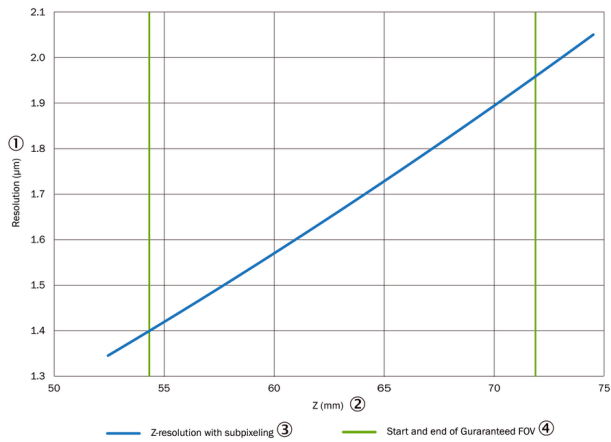

X resolution via Z position

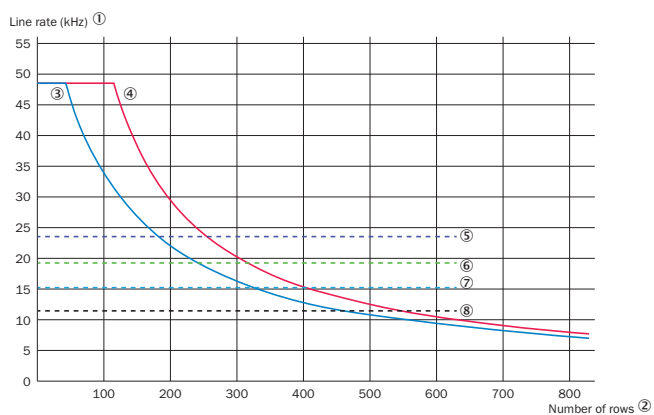
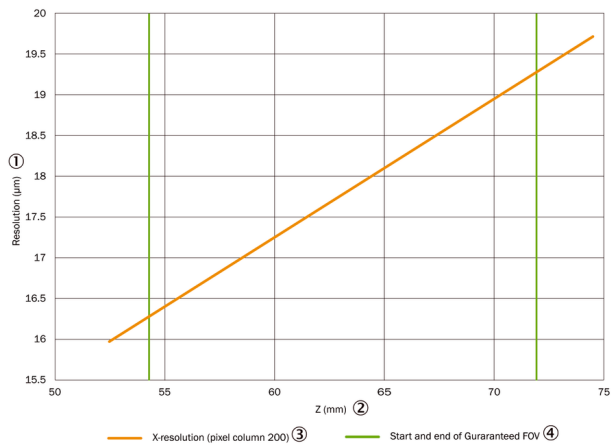



The maximum line rate is based on the number of sensor lines used

- ① Line rate (kHz)
- ② Number of lines
- ③ Ruler3000 with activated HDR
- ④ Ruler3000 without activated HDR
- ⑤ Bandwidth limit for image width 2,560, height range only
- ⑥ Bandwidth limit for image width 3,072, height range only
- ⑦ Bandwidth limit for image width 2,560, height range and reflectance
- ⑧ Bandwidth limit for image width 3,072, height range and reflectance

### Recommended accessories

Other models and accessories → [www.sick.com/Ruler3000](http://www.sick.com/Ruler3000)

	Brief description	Type	Part no.
Plug connectors and cables			
	<ul style="list-style-type: none"> <li>• <b>Connection type head A:</b> Female connector, M12, 17-pin, straight, A-coded</li> <li>• <b>Connection type head B:</b> Flying leads</li> <li>• <b>Signal type:</b> Sensor/actuator cable, serial, CANopen, digital I/Os</li> <li>• <b>Cable:</b> 3 m, 17-wire, PUR</li> <li>• <b>Description:</b> Sensor/actuator cable, serial, CANopen, digital I/Os, twisted pair, shielded</li> <li>• <b>Application:</b> Drag chain operation</li> </ul>	YF2A2D-030UV1XLEAX	6042772
	<ul style="list-style-type: none"> <li>• <b>Connection type head A:</b> Male connector, M12, 8-pin, straight, X-coded</li> <li>• <b>Connection type head B:</b> Male connector, RJ45, 8-pin, straight</li> <li>• <b>Signal type:</b> Ethernet, Gigabit Ethernet</li> <li>• <b>Cable:</b> 2 m, 8-wire, PUR, halogen-free</li> <li>• <b>Description:</b> Ethernet, Gigabit Ethernet, shielded</li> <li>• <b>Application:</b> Zones with oils and lubricants</li> </ul>	YM2X18-020EG1MRJA8	2106258

### Recommended services

Additional services → [www.sick.com/Ruler3000](http://www.sick.com/Ruler3000)

	Type	Part no.
Extended warranty		
<ul style="list-style-type: none"> <li>• <b>Product area:</b> Identification solutions, machine vision, Detection and ranging solutions, safety camera sensors, Safety laser scanners, Safety radar sensors</li> <li>• <b>Range of services:</b> The services correspond to the scope of the statutory manufacturer warranty (SICK general terms of delivery).</li> <li>• <b>Duration:</b> Five-year warranty from delivery date.</li> </ul>	Extended warranty for a total of five years from delivery date	1680671



## SICK AT A GLANCE

SICK is one of the leading manufacturers of intelligent sensors and sensor solutions for industrial applications. A unique range of products and services creates the perfect basis for controlling processes securely and efficiently, protecting individuals from accidents and preventing damage to the environment.

We have extensive experience in a wide range of industries and understand their processes and requirements. With intelligent sensors, we can deliver exactly what our customers need. In application centers in Europe, Asia and North America, system solutions are tested and optimized in accordance with customer specifications. All this makes us a reliable supplier and development partner.

Comprehensive services complete our offering: SICK LifeTime Services provide support throughout the machine life cycle and ensure safety and productivity.

For us, that is “Sensor Intelligence.”

## WORLDWIDE PRESENCE:

Contacts and other locations –[www.sick.com](http://www.sick.com)