



## Features

Use: Indoor  
Type of installation: TRACK  
Emission: ADJUSTABLE  
Optics: SPOT  
Beam: 15 - 38°  
Colour: BLACK  
Dimming: DALI  
Emergency: NO  
L: 275mm  
A: Ø55mm  
H: 150mm  
Warranty: 5 years

## Tech data

Luminaire input power: 20W  
IP: 20  
Insulation class: II  
Supply voltage: 220-240V 50/60Hz  
SELV: Si

## Source

Light source: LED  
Source power: 20W  
Source luminous flux: 1830lm  
Colour temperature: 3000K  
CRI: >90  
LED lifespan: 30000h L70 B20

## Compliance

CEI EN 60598-1:2015 + A11:2009. IEC 60598-2:2015 2-1

## Standards

Photobiological risk: RISK GROUP 1 Certified fixture in RISK GROUP 1 (Low Risk)-The fixture does not pose a hazard due to normal behavioral limitations on exposure - in accordance with CEI EN 62471:2010-01, IEC TR 62778:2014.

CAM edilizia: The product complies with the requirements for public buildings, ministerial decree of 23rd June 2022 n.256.

[View more product info](#)

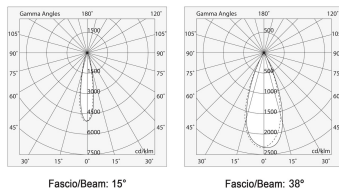
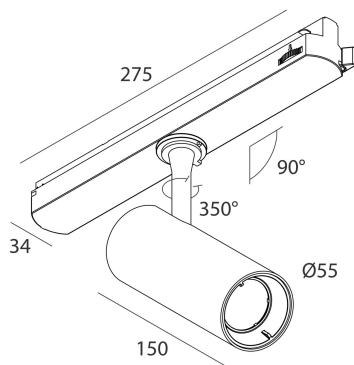

**SCREENS**

---



DALÌ : LENTE 55° PER 20W

**106113.00**

**COMPLETION ACCESSORIES**

---



DALÌ : INSERTO ORO OPACO PER 20W

**106109.15**



DALÌ : HONEYCOMB PER 20W

**106111.02**