

Part number

# TAPC 24.40



Surface mounting housing, T-TYPE/C series,  
with 2 levers, M40 cable entry, size "104.27"

#### Product description

<b>Product type</b>	Surface mounting housing
<b>Series</b>	T-TYPE/C
<b>Closing type</b>	With 2 levers
<b>Size</b>	Size 104.27
<b>Cable entry</b>	With cable entry M40

#### Technical data

**IP degree of protection** IP66 / IP69

#### Further technical details

<b>Weight</b>	190,50 g
<b>Operating temperature range (min, max)</b>	-50°C ... +70°C

#### Material properties

<b>Main material</b>	Polypropylene (PP)
<b>Other materials</b>	Lever: Polypropylene (PP) Gasket: Silicone rubber
<b>Colour</b>	RAL 7012 grey, RAL 5005 blue
<b>RoHs conformity</b>	Compliant
<b>China RoHs - EFUP</b>	E
<b>REACH SVHC substances</b>	No

#### General ordering information

<b>EAN13 code</b>	8015747211994
<b>eCl@ss 8.1</b>	27440202
<b>ETIM 7.0</b>	EC000437

#### Packaging Information

<b>Packaging length</b>	330,00 mm
<b>Packaging height</b>	220,00 mm
<b>Packaging width</b>	310,00 mm
<b>Packaging weight</b>	4,21 kg
<b>Packaging volume</b>	22,51 dm <sup>3</sup>
<b>Packaging description</b>	Carton box
<b>Packaging quantity</b>	20 Pcs
<b>Packaging EAN code</b>	8015747212144
<b>Sub-packaging weight</b>	1,05 kg
<b>Sub-packaging description</b>	Plastic packaging
<b>Sub-packaging quantity</b>	5 Pcs
<b>Sub-packaging EAN barcode</b>	8015747212151

Part number

# TAPC 24.40



## Catalogue drawings

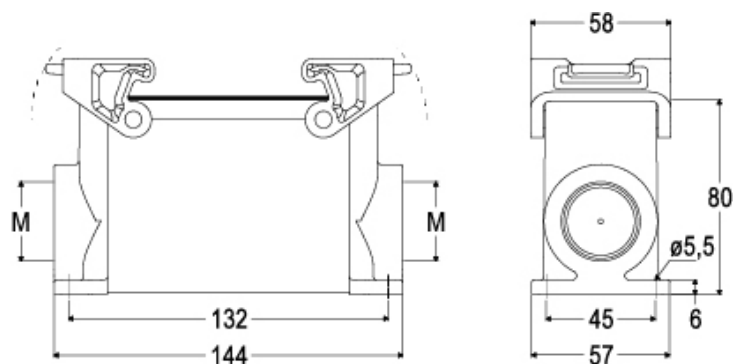

## Notes

Dimensions shown in mm are not binding and may be changed without notice.

---