

E.straw / Strawberry, source d'eau chaude - États-Unis



Réversible	Fonctionnement	Pression maximale de service	Température maximale de service	Connexions
Oui	Eau chaude	5 bar	110 °C	2 x F 1/2" et 2 x F 1/2" pour le purgeur

Matériel :

Unique corps chauffant en acier peint, épaisseur 7 mm.

Fixation :

Consoles, purgeur, clé hexagonale, vis et chevrons pour parois en dur, instructions de montage fournies. (Le kit est conforme à la norme VDI 6036 - classe 4).

Emballage :

Le radiateur est protégé par carton et un film plastique. Le tout est entièrement recyclable. Notice d'instruction incluse.

Traitement de surface :

Peinture époxy-polyester écologique (processus certifié selon DIN 55900-1,-2).

Rendements thermiques certifiés auprès de laboratoires agréés selon la norme EN442.

Teintes :

Radiateur et accessoires : couleur standard Blanc RAL 9016 R02. Pour radiateurs et accessoires d'autres couleurs surcoût de 30 %.

Série E.straw

CODE RAL 9016 R02	CODE couleur nuancier ⁽¹⁾	Hauteur (mm)	Largeur L (mm)	Entraxe l (mm)	Poids à vide (kg)	Surface (m ²)	Capacité (Lt)	Puissance thermique EN 442 Δt = 50 °C (75/65/20 °C) Watt
EST1120R02	ajouter au code blanc la lettre C + réf. couleur	1220	520	50	16,2	0,9	1,3	508

⁽¹⁾ Code EST1120 à compléter par la lettre C + le code couleur alphanumérique (1 lettre 2 chiffres – cf. nuancier en dernières pages).

Kit de raccordement (raccordements fournis)

Kit robinets et coude pour raccords cuivre (Ø 12/14/15) et raccords PER (Ø 16).

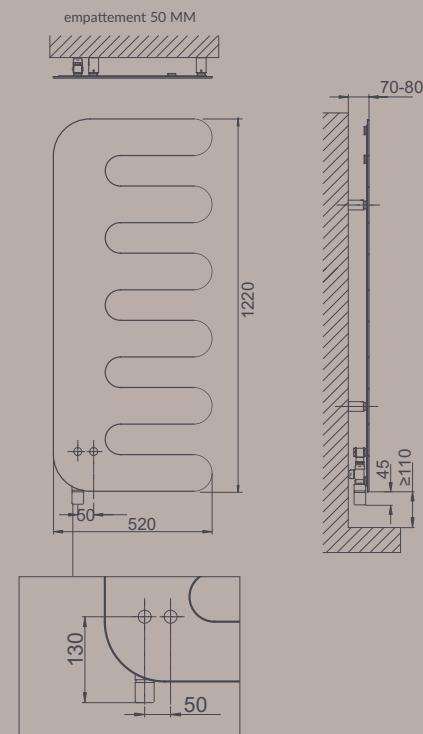

Nuancier RAL /

STANDARD



RAL 9010 - R01
Pure White



RAL 9016 - R02
Traffic White

GLOSSY

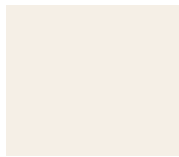

RAL 9001 - R14
Cream



S20
Jasmine

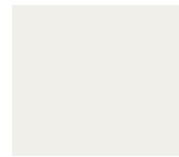

S03
Pergamon



S16
Canary



RAL 1013 - R40
Pearl White



S10
Anemone



RAL 1021 - R05
Yellow Rape



RAL 1004 - R06
Gold

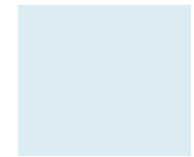

H04
Ice



H42
Blue Grotto



H09
Lake



RAL 5015 - R11
Blue Sky



RAL 5017 - R18
Overseas Blue



RAL 5022 - R19
Blue Night



RAL 9005 - R13
Jet Black



H24
Mango



H25
Tangerine



RAL 2004 - R16
Pure Orange



H27
Bright Red



RAL 3003 - R08
Ruby Red



RAL 4008 - R25
Purple



H53
Bright Lilac



H55
Pink Panther

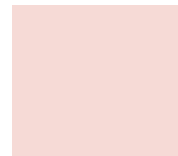

S13
Rosa Sussurrato

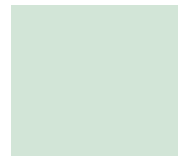

RAL 6019 - R26
Weissgrün



H30
Green Apple



RAL 6002 - R20
Green Leaf

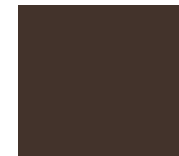

RAL 8017 - R09
Dark Brown



S17
Bahama Beige



H08
Dove



H56
Lavic Stone



S07
Graphite



RAL 7030 - R22
Stone Grey



S02
Manhattan



RAL 7001 - R21
Silver Grey

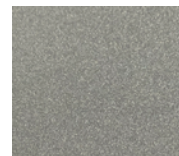

R27
Metal Grey

MATT



T01
Matt Black

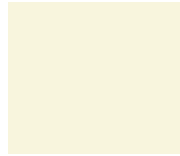

T10
Matt Beige



T11
Matt White



T12
Matt Light Grey



T13
Matt Grey



T14
Matt Brown



T15
Tela



T16
London Grey 7016

WAVY



W01
Notturmo



W02
Carbon

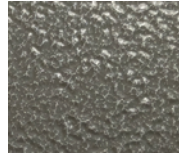

W03
Dolomite



W05
Snowflake



R31
Ivory

MELANGE

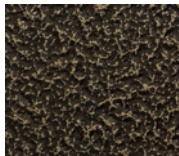

M01
Gold Black



M02
Black Brown

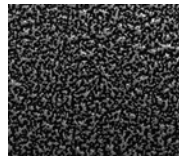

M04
Black Silver 2



M06
Gold White

SPECIAL FINISHING



F06
Metal Rough Black



F15
Metal Sparkling Black



F04
Graphite Grey



F03
Metal Anthracite

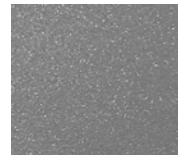

F09
Graphite Light Grey

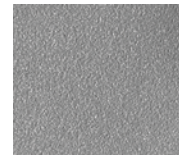

F07
Silver Effect



F20
Milky

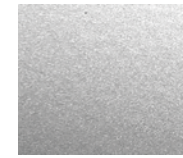

F18
Platinum



F22
Classic Gold

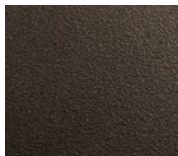

F14
Old Bronze Effect



F24
Black Star

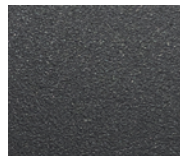

F23
Sparkling Grey



F25
Quartz Dust



F27
Moonshine

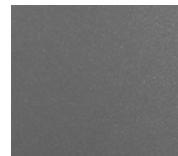

F26
Dark Aluminium



F30
White Sand

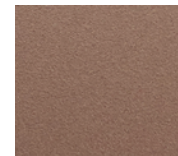

F38
Sandstone

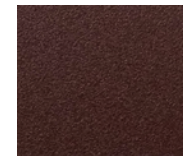

F34
Red Sand

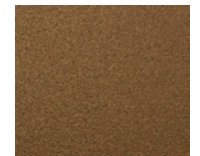

F31
Corten Brown

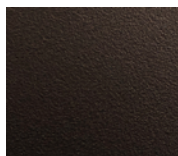

F36
Terra



F35
Forest Green

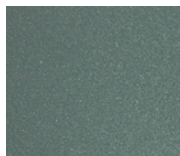

F33
Emerald Sand



F32
Grey Sky

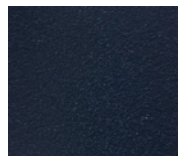

F37
Denim Blue

Cette gamme de couleurs a été produite par notre société. En aucun cas elle ne peut être prise comme une reproduction certifiée par « RAL Deutsches Institut ». Toutes les couleurs énumérées dans cet exemple sont indicatives de la finale Couleur. Vous pouvez rencontrer de légères variations de teinte dues au processus d'application ou de fabrication. Ces légères variations ne doivent pas être considérées comme des défauts de fabrication.