

Part number

CAP 10 CP2



Surface mounting housing, C-TYPE series, with 4 pegs, Pg21 x 2 cable entry, size "57.27", high construction, with plastic cover

Product description

Product type	Surface mounting housing
Series	C-TYPE
Closing type	With 4 pegs
Size	Size 57.27
Cable entry	With cable entry Pg21 x 2
Specification	High construction, with plastic cover

Technical data

IP degree of protection IP65

Further technical details

Weight	320,00 g
Operating temperature range (min, max)	-40°C...+125°C

Material properties

Other materials	Gasket: NBR
Colour	RAL 7040 grey
RoHs conformity	Compliant
China RoHs - EFUP	E
REACH SVHC substances	No

Approvals / Standards

Certifications	DNV, BV
UL	ECBT2
cUL	ECBT8

General ordering information

EAN13 code 8015747007535

Packaging Information

Packaging length	475,00 mm
Packaging height	200,00 mm
Packaging width	150,00 mm
Packaging weight	3,58 kg
Packaging volume	14,25 dm ³
Packaging description	Carton box
Packaging quantity	10 Pcs
Packaging EAN code	8015747236195
Sub-packaging weight	1,79 kg
Sub-packaging description	Plastic packaging
Sub-packaging quantity	5 Pcs
Sub-packaging EAN barcode	8015747236201

Part number

CAP 10 CP2



Catalogue drawings

CHP CAP - MHP MAP



CHP CS/CP CAP CS/CP - MHP CS/CP MAP CS/CP

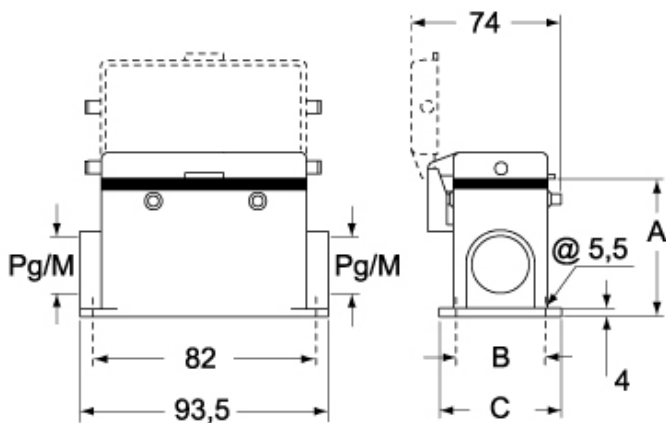

	A	B	C
CHP L / MHP L	57	40	52
CAP L / MAP L	73	45	57
CHP CS / MHP CS	57	40	52
CAP CS / MAP CS	73	45	57
CHP CP / MHP CP	57	40	52
CAP CP / MAP CP	73	45	57

Notes

Dimensions shown in mm are not binding and may be changed without notice.